OpenModelica User's Guide

Release v1.16.0-dev.beta3-22-gfeadc57b32

Open Source Modelica Consortium

Oct 14, 2020

CONTENTS

1	Introduction	3
1.1	System Overview	4
1.2	Interactive Session with Examples	5
1.3	Summary of Commands for the Interactive Session Handler	24
1.4	Running the compiler from command line	25
2	OMEdit – OpenModelica Connection Editor	27
2.1	Starting OMEdit	27
2.2	MainWindow & Browsers	28
2.3	Perspectives	32
2.4	File Menu	37
2.5	Edit Menu	38
2.6	View Menu	38
2.7	Simulation Menu	38
2.8	Debug Menu	39
2.9	SSP Menu	39
2.10	Sensitivity Optimization Menu	39
2.11	Tools Menu	39
2.12	Help Menu	39
2.13	Modeling a Model	40
2.14	Simulating a Model	42
2.15	2D Plotting	45
2.16	Re-simulating a Model	46
2.17	3D Visualization	46
2.18	Animation of Realtime FMUs	49
2.19	Interactive Simulation	50
2.20	How to Create User Defined Shapes – Icons	50
2.21	Global head section in documentation	51
2.22	Options	52
2.23	__OpenModelica_commandLineOptions Annotation	59
2.24	__OpenModelica_simulationFlags Annotation	59
2.25	Debugger	60
2.26	Editing Modelica Standard Library	60
2.27	State Machines	60
2.28	Using OMEdit as Text Editor	63
2.29	Temporary Directory, Log Files and Working Directory	65
3	2D Plotting	69
3.1	Example	69
3.2	Plot Command Interface	71
4	Solving Modelica Models	73
4.1	Integration Methods	73
4.2	DAE Mode Simulation	75

4.3	Initialization	75
5	Debugging	79
5.1	The Equation-based Debugger	79
5.2	The Algorithmic Debugger	82
6	Generating Graph Representations for Models	87
7	FMI and TLM-Based Simulation and Co-simulation of External Models	89
7.1	Functional Mock-up Interface - FMI	89
7.2	Transmission Line Modeling (TLM) Based Co-Simulation	92
7.3	Composite Model Editing of External Models	92
8	OMSimulator	107
8.1	Introduction	107
8.2	OMSimulator	107
8.3	OMSimulatorLib	109
8.4	OMSimulatorLua	124
8.5	OMSimulatorPython	140
8.6	OpenModelicaScripting	156
8.7	Graphical Modelling	172
8.8	SSP Support	176
9	System Identification	185
10	OpenModelica Encryption	187
10.1	Encrypting the Library	187
10.2	Loading an Encrypted Library	187
10.3	Notes	187
11	OMNotebook with DrModelica and DrControl	189
11.1	Interactive Notebooks with Literate Programming	189
11.2	DrModelica Tutoring System – an Application of OMNotebook	190
11.3	DrControl Tutorial for Teaching Control Theory	196
11.4	OpenModelica Notebook Commands	206
11.5	References	211
12	Optimization with OpenModelica	213
12.1	Builtin Dynamic Optimization with OpenModelica and IpOpt	213
12.2	Compiling the Modelica code	213
12.3	An Example	214
12.4	Different Options for the Optimizer IPOPT	216
12.5	Dynamic Optimization with OpenModelica and CasADi	216
12.6	Parameter Sweep Optimization using OMOptim	221
13	Parameter Sensitivities with OpenModelica	229
13.1	Single Parameter sensitivities with IDA/Sundials	229
13.2	Single and Multi-parameter sensitivities with OMSens	231
14	PDEModelica1	245
14.1	PDEModelica1 language elements	245
14.2	Limitations	246
14.3	Viewing results	246
15	MDT – The OpenModelica Development Tooling Eclipse Plugin	247
15.1	Introduction	247
15.2	Installation	247
15.3	Getting Started	248

16	MDT Debugger for Algorithmic Modelica	263
16.1	The Eclipse-based Debugger for Algorithmic Modelica	263
17	Modelica Performance Analyzer	271
17.1	Profiling information for ProfilingTest	272
17.2	Generated JSON for the Example	274
17.3	Using the Profiler from OMEdit	275
18	Simulation in Web Browser	277
19	Interoperability – C and Python	279
19.1	Calling External C functions	279
19.2	Calling external Python Code from a Modelica model	281
19.3	Calling OpenModelica from Python Code	282
20	OpenModelica Python Interface and PySimulator	285
20.1	OMPpython – OpenModelica Python Interface	285
20.2	Enhanced OMPython Features	288
20.3	PySimulator	292
21	OMMatlab – OpenModelica Matlab Interface	293
21.1	Features of OMMatlab	293
21.2	Test Commands	293
21.3	WorkDirectory	295
21.4	BuildModel	295
21.5	Standard get methods	295
21.6	Usage of getMethods	295
21.7	Standard set methods	297
21.8	Usage of setMethods	298
21.9	Advanced Simulation	298
21.10	Linearization	299
21.11	Usage of Linearization methods	299
22	OMJulia – OpenModelica Julia Scripting	301
22.1	Features of OMJulia	301
22.2	Test Commands	301
22.3	WorkDirectory	303
22.4	BuildModel	303
22.5	Standard get methods	303
22.6	Usage of getMethods	303
22.7	Standard set methods	305
22.8	Usage of setMethods	305
22.9	Advanced Simulation	305
22.10	Linearization	306
22.11	Usage of Linearization methods	306
22.12	Sensitivity Analysis	306
22.13	Usage	307
23	Jupyter-OpenModelica	309
24	Scripting API	311
24.1	OpenModelica Scripting Commands	311
24.2	Simulation Parameter Sweep	387
24.3	Examples	387
25	Package manager	393
25.1	Installing packages	393
25.2	How the package index works	396

26	OpenModelica Compiler Flags	397
26.1	Options	397
26.2	Debug flags	413
26.3	Flags for Optimization Modules	419
27	Small Overview of Simulation Flags	421
27.1	OpenModelica (C-runtime) Simulation Flags	421
28	Technical Details	429
28.1	The MATv4 Result File Format	429
29	DataReconciliation	431
29.1	Defining DataReconciliation Problem in OpenModelica	431
29.2	DataReconciliation Support with Scripting Interface	433
29.3	DataReconciliation Support in OMEdit	433
29.4	DataReconciliation Results	437
30	Frequently Asked Questions (FAQ)	441
30.1	OpenModelica General	441
30.2	OMNotebook	441
30.3	OMDev - OpenModelica Development Environment	442
31	Major OpenModelica Releases	443
31.1	Release Notes for OpenModelica 1.16.0	443
31.2	Release Notes for OpenModelica 1.15.0	444
31.3	Release Notes for OpenModelica 1.14.0	444
31.4	Release Notes for OpenModelica 1.13.0	446
31.5	Release Notes for OpenModelica 1.12.0	446
31.6	Release Notes for OpenModelica 1.11.0	448
31.7	Release Notes for OpenModelica 1.10.0	450
31.8	Release Notes for OpenModelica 1.9.4	451
31.9	Release Notes for OpenModelica 1.9.3	452
31.10	Release Notes for OpenModelica 1.9.2	453
31.11	Release Notes for OpenModelica 1.9.1	454
31.12	Release Notes for OpenModelica 1.9.0	456
31.13	Release Notes for OpenModelica 1.8.1	459
31.14	OpenModelica 1.8.0, November 2011	460
31.15	OpenModelica 1.7.0, April 2011	461
31.16	OpenModelica 1.6.0, November 2010	462
31.17	OpenModelica 1.5.0, July 2010	463
31.18	OpenModelica 1.4.5, January 2009	464
31.19	OpenModelica 1.4.4, Feb 2008	465
31.20	OpenModelica 1.4.3, June 2007	465
31.21	OpenModelica 1.4.2, October 2006	466
31.22	OpenModelica 1.4.1, June 2006	467
31.23	OpenModelica 1.4.0, May 2006	467
31.24	OpenModelica 1.3.1, November 2005	468
32	Contributors to OpenModelica	471
32.1	OpenModelica Contributors 2015	471
32.2	OpenModelica Contributors 2014	473
32.3	OpenModelica Contributors 2013	474
32.4	OpenModelica Contributors 2012	476
32.5	OpenModelica Contributors 2011	478
32.6	OpenModelica Contributors 2010	479
32.7	OpenModelica Contributors 2009	481
32.8	OpenModelica Contributors 2008	482
32.9	OpenModelica Contributors 2007	483
32.10	OpenModelica Contributors 2006	484

32.11 OpenModelica Contributors 2005	484
32.12 OpenModelica Contributors 2004	485
32.13 OpenModelica Contributors 2003	485
32.14 OpenModelica Contributors 2002	486
32.15 OpenModelica Contributors 2001	486
32.16 OpenModelica Contributors 2000	486
32.17 OpenModelica Contributors 1999	486
32.18 OpenModelica Contributors 1998	487
Bibliography	489
Index	491

Generated on 2020-10-14 at 07:09

Open Source Modelica Consortium

Copyright © 1998-*CurrentYear*, Open Source Modelica Consortium (OSMC), c/o Linköpings universitet, Department of Computer and Information Science, SE-58183 Linköping, Sweden

All rights reserved.

THIS PROGRAM IS PROVIDED UNDER THE TERMS OF GPL VERSION 3 LICENSE OR THIS OSMC PUBLIC LICENSE (OSMC-PL). ANY USE, REPRODUCTION OR DISTRIBUTION OF THIS PROGRAM CONSTITUTES RECIPIENT'S ACCEPTANCE OF THE OSMC PUBLIC LICENSE OR THE GPL VERSION 3, ACCORDING TO RECIPIENTS CHOICE.

The OpenModelica software and the OSMC (Open Source Modelica Consortium) Public License (OSMC-PL) are obtained from OSMC, either from the above address, from the URLs: <https://www.openmodelica.org> or <http://www.ida.liu.se/projects/OpenModelica>, and in the OpenModelica distribution. GNU version 3 is obtained from: <http://www.gnu.org/copyleft/gpl.html>.

This program is distributed WITHOUT ANY WARRANTY; without even the implied warranty of MERCHANTABILITY or FITNESS FOR A PARTICULAR PURPOSE, EXCEPT AS EXPRESSLY SET FORTH IN THE BY RECIPIENT SELECTED SUBSIDIARY LICENSE CONDITIONS OF OSMC-PL.

See the full OSMC Public License conditions for more details.

This document is part of OpenModelica: <https://www.openmodelica.org>

Contact: OpenModelica@ida.liu.se

Modelica® is a registered trademark of the Modelica Association, <https://www.Modelica.org>

Mathematica® is a registered trademark of Wolfram Research Inc, <http://www.wolfram.com>

This users guide provides documentation and examples on how to use the OpenModelica system, both for the Modelica beginners and advanced users.

INTRODUCTION

The **OpenModelica** system described in this document has both short-term and long-term goals:

- The short-term goal is to develop an efficient interactive computational environment for the Modelica language, as well as a rather complete implementation of the language. It turns out that with support of appropriate tools and libraries, Modelica is very well suited as a computational language for development and execution of both low level and high level numerical algorithms, e.g. for control system design, solving nonlinear equation systems, or to develop optimization algorithms that are applied to complex applications.
- The long-term goal is to have a complete reference implementation of the Modelica language, including simulation of equation based models and additional facilities in the programming environment, as well as convenient facilities for research and experimentation in language design or other research activities. However, our goal is not to reach the level of performance and quality provided by current commercial Modelica environments that can handle large models requiring advanced analysis and optimization by the Modelica compiler.

The long-term *research* related goals and issues of the OpenModelica open source implementation of a Modelica environment include but are not limited to the following:

- Development of a *complete formal specification* of Modelica, including both static and dynamic semantics. Such a specification can be used to assist current and future Modelica implementers by providing a semantic reference, as a kind of reference implementation.
- *Language design*, e.g. to further *extend the scope* of the language, e.g. for use in diagnosis, structural analysis, system identification, etc., as well as modeling problems that require extensions such as partial differential equations, enlarged scope for discrete modeling and simulation, etc.
- *Language design to improve abstract properties* such as expressiveness, orthogonality, declarativity, reuse, configurability, architectural properties, etc.
- *Improved implementation techniques*, e.g. to enhance the performance of compiled Modelica code by generating code for parallel hardware.
- *Improved debugging* support for equation based languages such as Modelica, to make them even easier to use.
- *Easy-to-use* specialized high-level (graphical) *user interfaces* for certain application domains.
- *Visualization* and animation techniques for interpretation and presentation of results.
- *Application usage* and model library development by researchers in various application areas.

The OpenModelica environment provides a test bench for language design ideas that, if successful, can be submitted to the Modelica Association for consideration regarding possible inclusion in the official Modelica standard.

The current version of the OpenModelica environment allows most of the expression, algorithm, and function parts of Modelica to be executed interactively, as well as equation models and Modelica functions to be compiled into efficient C code. The generated C code is combined with a library of utility functions, a run-time library, and a numerical DAE solver.

1.1 System Overview

The OpenModelica environment consists of several interconnected subsystems, as depicted in Figure 1.1.



Figure 1.1: The architecture of the OpenModelica environment. Arrows denote data and control flow. The interactive session handler receives commands and shows results from evaluating commands and expressions that are translated and executed. Several subsystems provide different forms of browsing and textual editing of Modelica code. The debugger currently provides debugging of an extended algorithmic subset of Modelica.

The following subsystems are currently integrated in the OpenModelica environment:

- *An interactive session handler*, that parses and interprets commands and Modelica expressions for evaluation, simulation, plotting, etc. The session handler also contains simple history facilities, and completion of file names and certain identifiers in commands.
- *A Modelica compiler subsystem*, translating Modelica to C code, with a symbol table containing definitions of classes, functions, and variables. Such definitions can be predefined, user-defined, or obtained from libraries. The compiler also includes a Modelica interpreter for interactive usage and constant expression evaluation. The subsystem also includes facilities for building simulation executables linked with selected numerical ODE or DAE solvers.
- *An execution and run-time module*. This module currently executes compiled binary code from translated expressions and functions, as well as simulation code from equation based models, linked with numerical solvers. In the near future event handling facilities will be included for the discrete and hybrid parts of the Modelica language.
- *Eclipse plugin editor/browser*. The Eclipse plugin called MDT (Modelica Development Tooling) provides file and class hierarchy browsing and text editing capabilities, rather analogous to previously described Emacs editor/browser. Some syntax highlighting facilities are also included. The Eclipse framework has the advantage of making it easier to add future extensions such as refactoring and cross referencing support.
- *OMNotebook DrModelica model editor*. This subsystem provides a lightweight notebook editor, compared to the more advanced Mathematica notebooks available in MathModelica. This basic functionality still allows essentially the whole DrModelica tutorial to be handled. Hierarchical text documents with chapters and sections can be represented and edited, including basic formatting. Cells can contain ordinary text or Modelica models and expressions, which can be evaluated and simulated. However, no mathematical typesetting facilities are yet available in the cells of this notebook editor.
- *Graphical model editor/browser OMEdit*. This is a graphical connection editor, for component based model design by connecting instances of Modelica classes, and browsing Modelica model libraries for reading and picking component models. The graphical model editor also includes a textual editor for editing model class definitions, and a window for interactive Modelica command evaluation.

- *Optimization subsystem OMOptim.* This is an optimization subsystem for OpenModelica, currently for design optimization choosing an optimal set of design parameters for a model. The current version has a graphical user interface, provides genetic optimization algorithms and Pareto front optimization, works integrated with the simulators and automatically accesses variables and design parameters from the Modelica model.
- *Dynamic Optimization subsystem.* This is dynamic optimization using collocation methods, for Modelica models extended with optimization specifications with goal functions and additional constraints. This subsystem is integrated with in the OpenModelica compiler.
- *Modelica equation model debugger.* The equation model debugger shows the location of an error in the model equation source code. It keeps track of the symbolic transformations done by the compiler on the way from equations to low-level generated C code, and also explains which transformations have been done.
- *Modelica algorithmic code debugger.* The algorithmic code Modelica debugger provides debugging for an extended algorithmic subset of Modelica, excluding equation-based models and some other features, but including some meta-programming and model transformation extensions to Modelica. This is a conventional full-feature debugger, using Eclipse for displaying the source code during stepping, setting breakpoints, etc. Various back-trace and inspection commands are available. The debugger also includes a data-view browser for browsing hierarchical data such as tree- or list structures in extended Modelica.

1.2 Interactive Session with Examples

The following is an interactive session using the interactive session handler in the OpenModelica environment, called OMShell – the OpenModelica Shell). Most of these examples are also available in the *OMNotebook with DrModelica and DrControl UsersGuideExamples.onb* as well as the testmodels in:

```
>>> getInstallationDirectoryPath() + "/share/doc/omc/testmodels/"
"«OPENMODELICAHOME»/share/doc/omc/testmodels/"
```

The following commands were run using OpenModelica version:

```
>>> getVersion()
"OMCompiler v1.16.0-dev.beta3.22+gfeadc57b32"
```

1.2.1 Starting the Interactive Session

The Windows version which at installation is made available in the start menu as OpenModelica->OpenModelica Shell which responds with an interaction window:

We enter an assignment of a vector expression, created by the range construction expression 1:12, to be stored in the variable x. The value of the expression is returned.

```
>>> x := 1:12
{1, 2, 3, 4, 5, 6, 7, 8, 9, 10, 11, 12}
```

1.2.2 Using the Interactive Mode

When running OMC in interactive mode (for instance using OMShell) one can make load classes and execute commands. Here we give a few example sessions.

Example Session 1

```
>>> model A Integer t = 1.5; end A; //The type is Integer but 1.5 is of Real Type
{A}
>>> instantiateModel(A)
""
"[<interactive>:1:9-1:23:writable] Error: Type mismatch in binding t = 1.5,
↳expected subtype of Integer, got type Real.
Error: Error occurred while flattening model A
"
```

Example Session 2

If you do not see the error-message when running the example, use the command `getErrorString()`.

```
model C
  Integer a;
  Real b;
equation
  der(a) = b; // der(a) is illegal since a is not a Real number
  der(b) = 12.0;
end C;
```

```
>>> instantiateModel(C)
""
```

Error:

```
[<interactive>:5:3-5:13:writable] Error: Argument 'a' to der has illegal type Integer, must be a subtype of Real.
Error: Error occurred while flattening model C
```

1.2.3 Trying the Bubblesort Function

Load the function `bubblesort`, either by using the pull-down menu `File->Load Model`, or by explicitly giving the command:

```
>>> loadFile(getInstallationDirectoryPath() + "/share/doc/omc/testmodels/
↳bubblesort.mo")
true
```

The function `bubblesort` is called below to sort the vector `x` in descending order. The sorted result is returned together with its type. Note that the result vector is of type `Real[12]`, instantiated as `Real[12]`, since this is the declared type of the function result. The input `Integer` vector was automatically converted to a `Real` vector according to the Modelica type coercion rules. The function is automatically compiled when called if this has not been done before.

```
>>> bubblesort(x)
{12.0,11.0,10.0,9.0,8.0,7.0,6.0,5.0,4.0,3.0,2.0,1.0}
```

Another call:

```
>>> bubblesort({4,6,2,5,8})
{8.0,6.0,5.0,4.0,2.0}
```

1.2.4 Trying the system and cd Commands

It is also possible to give operating system commands via the system utility function. A command is provided as a string argument. The example below shows the system utility applied to the UNIX command `cat`, which here outputs the contents of the file `bubblesort.mo` to the output stream when running `omc` from the command-line.

```
>>> system("cat '"+getInstallationDirectoryPath()+"/share/doc/omc/testmodels/
↳bubblesort.mo' > bubblesort.mo")
0
```

```
function bubblesort
  input Real[:] x;
  output Real[size(x,1)] y;
protected
  Real t;
algorithm
  y := x;
  for i in 1:size(x,1) loop
    for j in 1:size(x,1) loop
      if y[i] > y[j] then
        t := y[i];
        y[i] := y[j];
        y[j] := t;
      end if;
    end for;
  end for;
end bubblesort;
```

Note: The output emitted into `stdout` by system commands is put into log-files when running the CORBA-based clients, not into the visible GUI windows. Thus the text emitted by the above `cat` command would not be returned, which is why it is redirected to another file.

A better way to read the content of files would be the `readFile` command:

```
>>> readFile("bubblesort.mo")
function bubblesort
  input Real[:] x;
  output Real[size(x,1)] y;
protected
  Real t;
algorithm
  y := x;
  for i in 1:size(x,1) loop
    for j in 1:size(x,1) loop
      if y[i] > y[j] then
        t := y[i];
        y[i] := y[j];
        y[j] := t;
      end if;
    end for;
  end for;
end bubblesort;
```

The system command only returns a success code (0 = success).

```
>>> system("dir")
0
>>> system("Non-existing command")
127
```

Another built-in command is `cd`, the *change current directory* command. The resulting current directory is returned as a string.

```
>>> dir:=cd()
"«DOCHOME»"
>>> cd("source")
"«DOCHOME»/source"
>>> cd(getInstallationDirectoryPath() + "/share/doc/omc/testmodels/")
"/var/lib/jenkins2/ws/OpenModelica_maintenance_v1.16/build/share/doc/omc/testmodels
↪"
>>> cd(dir)
"«DOCHOME»"
```

1.2.5 Modelica Library and DCMotor Model

We load a model, here the whole Modelica standard library, which also can be done through the File->Load Modelica Library menu item:

```
>>> loadModel(Modelica)
true
```

We also load a file containing the dcmotor model:

```
>>> loadFile(getInstallationDirectoryPath() + "/share/doc/omc/testmodels/dcmotor.mo
↪")
true
```

Note:

Notification: dcmotor requested package Modelica of version 3.2.2. Modelica 3.2.3 is used instead which states that it is fully compatible without conversion script needed.

It is simulated:

```
>>> simulate(dcmotor, startTime=0.0, stopTime=10.0)
record SimulationResult
  resultFile = "«DOCHOME»/dcmotor_res.mat",
  simulationOptions = "startTime = 0.0, stopTime = 10.0, numberOfIntervals = 500,
↪ tolerance = 1e-06, method = 'dassl', fileNamePrefix = 'dcmotor', options = '',
↪ outputFormat = 'mat', variableFilter = '.*', cflags = '', simflags = '',
  messages = "LOG_SUCCESS | info | The initialization finished_
↪ successfully without homotopy method.
LOG_SUCCESS | info | The simulation finished successfully.
",
  timeFrontend = 0.407745291,
  timeBackend = 0.010637367,
  timeSimCode = 0.002964585,
  timeTemplates = 0.0050087920000000001,
  timeCompile = 0.475277152,
  timeSimulation = 0.019622002,
  timeTotal = 0.921399949
end SimulationResult;
```

Note:

Notification: dcmotor requested package Modelica of version 3.2.2. Modelica 3.2.3 is used instead which states that it is fully compatible without conversion script needed.

We list the source code of the model:

```

>>> list(dcmotor)
model dcmotor
  import Modelica.Electrical.Analog.Basic;
  Basic.Resistor resistor1(R = 10);
  Basic.Inductor inductor1(L = 0.2, i.fixed = true);
  Basic.Ground ground1;
  Modelica.Mechanics.Rotational.Components.Inertia load(J = 1, phi.fixed = true, w.
↪fixed = true);
  Basic.EMF emf1(k = 1.0);
  Modelica.Blocks.Sources.Step step1;
  Modelica.Electrical.Analog.Sources.SignalVoltage signalVoltage1;
equation
  connect(step1.y, signalVoltage1.v);
  connect(signalVoltage1.p, resistor1.p);
  connect(resistor1.n, inductor1.p);
  connect(inductor1.n, emf1.p);
  connect(emf1.flange, load.flange_a);
  connect(signalVoltage1.n, ground1.p);
  connect(ground1.p, emf1.n);
  annotation(
    uses(Modelica(version = "3.2.2")));
end dcmotor;

```

We test code instantiation of the model to flat code:

```

>>> instantiateModel(dcmotor)
class dcmotor
  Real resistor1.v(quantity = "ElectricPotential", unit = "V") "Voltage drop of
↪the two pins (= p.v - n.v)";
  Real resistor1.i(quantity = "ElectricCurrent", unit = "A") "Current flowing from
↪pin p to pin n";
  Real resistor1.p.v(quantity = "ElectricPotential", unit = "V") "Potential at the
↪pin";
  Real resistor1.p.i(quantity = "ElectricCurrent", unit = "A") "Current flowing
↪into the pin";
  Real resistor1.n.v(quantity = "ElectricPotential", unit = "V") "Potential at the
↪pin";
  Real resistor1.n.i(quantity = "ElectricCurrent", unit = "A") "Current flowing
↪into the pin";
  parameter Boolean resistor1.useHeatPort = false "=true, if heatPort is enabled";
  parameter Real resistor1.T(quantity = "ThermodynamicTemperature", unit = "K",
↪displayUnit = "degC", min = 0.0, start = 288.15, nominal = 300.0) = resistor1.T_
↪ref "Fixed device temperature if useHeatPort = false";
  Real resistor1.LossPower(quantity = "Power", unit = "W") "Loss power leaving
↪component via heatPort";
  Real resistor1.T_heatPort(quantity = "ThermodynamicTemperature", unit = "K",
↪displayUnit = "degC", min = 0.0, start = 288.15, nominal = 300.0) "Temperature
↪of heatPort";
  parameter Real resistor1.R(quantity = "Resistance", unit = "Ohm", start = 1.0) =
↪10.0 "Resistance at temperature T_ref";
  parameter Real resistor1.T_ref(quantity = "ThermodynamicTemperature", unit = "K",
↪displayUnit = "degC", min = 0.0, start = 288.15, nominal = 300.0) = 300.15
↪"Reference temperature";
  parameter Real resistor1.alpha(quantity = "LinearTemperatureCoefficient", unit =
↪"1/K") = 0.0 "Temperature coefficient of resistance (R_actual = R*(1 + alpha*(T_
↪heatPort - T_ref))";
  Real resistor1.R_actual(quantity = "Resistance", unit = "Ohm") "Actual
↪resistance = R*(1 + alpha*(T_heatPort - T_ref))";
  Real inductor1.v(quantity = "ElectricPotential", unit = "V") "Voltage drop of
↪the two pins (= p.v - n.v)";
  Real inductor1.i(quantity = "ElectricCurrent", unit = "A", start = 0.0, fixed =
↪true) "Current flowing from pin p to pin n";

```

(continues on next page)

(continued from previous page)

```

Real inductor1.p.v(quantity = "ElectricPotential", unit = "V") "Potential at the
↳pin";
Real inductor1.p.i(quantity = "ElectricCurrent", unit = "A") "Current flowing
↳into the pin";
Real inductor1.n.v(quantity = "ElectricPotential", unit = "V") "Potential at the
↳pin";
Real inductor1.n.i(quantity = "ElectricCurrent", unit = "A") "Current flowing
↳into the pin";
parameter Real inductor1.L(quantity = "Inductance", unit = "H", start = 1.0) = 0.
↳2 "Inductance";
Real ground1.p.v(quantity = "ElectricPotential", unit = "V") "Potential at the
↳pin";
Real ground1.p.i(quantity = "ElectricCurrent", unit = "A") "Current flowing into
↳the pin";
Real load.flange_a.phi(quantity = "Angle", unit = "rad", displayUnit = "deg")
↳"Absolute rotation angle of flange";
Real load.flange_a.tau(quantity = "Torque", unit = "N.m") "Cut torque in the
↳flange";
Real load.flange_b.phi(quantity = "Angle", unit = "rad", displayUnit = "deg")
↳"Absolute rotation angle of flange";
Real load.flange_b.tau(quantity = "Torque", unit = "N.m") "Cut torque in the
↳flange";
parameter Real load.J(quantity = "MomentOfInertia", unit = "kg.m2", min = 0.0,
↳start = 1.0) = 1.0 "Moment of inertia";
parameter enumeration (never, avoid, default, prefer, always) load.stateSelect =
↳StateSelect.default "Priority to use phi and w as states";
Real load.phi(quantity = "Angle", unit = "rad", displayUnit = "deg", fixed =
↳true, stateSelect = StateSelect.default) "Absolute rotation angle of component";
Real load.w(quantity = "AngularVelocity", unit = "rad/s", fixed = true,
↳stateSelect = StateSelect.default) "Absolute angular velocity of component (=
↳der(phi))";
Real load.a(quantity = "AngularAcceleration", unit = "rad/s2") "Absolute angular
↳acceleration of component (= der(w))";
parameter Boolean emf1.useSupport = false "= true, if support flange enabled,
↳otherwise implicitly grounded";
parameter Real emf1.k(quantity = "ElectricalTorqueConstant", unit = "N.m/A",
↳start = 1.0) = 1.0 "Transformation coefficient";
Real emf1.v(quantity = "ElectricPotential", unit = "V") "Voltage drop between
↳the two pins";
Real emf1.i(quantity = "ElectricCurrent", unit = "A") "Current flowing from
↳positive to negative pin";
Real emf1.phi(quantity = "Angle", unit = "rad", displayUnit = "deg") "Angle of
↳shaft flange with respect to support (= flange.phi - support.phi)";
Real emf1.w(quantity = "AngularVelocity", unit = "rad/s") "Angular velocity of
↳flange relative to support";
Real emf1.tau(quantity = "Torque", unit = "N.m") "Torque of flange";
Real emf1.tauElectrical(quantity = "Torque", unit = "N.m") "Electrical torque";
Real emf1.p.v(quantity = "ElectricPotential", unit = "V") "Potential at the pin";
Real emf1.p.i(quantity = "ElectricCurrent", unit = "A") "Current flowing into
↳the pin";
Real emf1.n.v(quantity = "ElectricPotential", unit = "V") "Potential at the pin";
Real emf1.n.i(quantity = "ElectricCurrent", unit = "A") "Current flowing into
↳the pin";
Real emf1.flange.phi(quantity = "Angle", unit = "rad", displayUnit = "deg")
↳"Absolute rotation angle of flange";
Real emf1.flange.tau(quantity = "Torque", unit = "N.m") "Cut torque in the flange
↳";
protected Real emf1.internalSupport.tau(quantity = "Torque", unit = "N.m") = -
↳emf1.tau "External support torque (must be computed via torque balance in model
↳where InternalSupport is used; = flange.tau)";
protected Real emf1.internalSupport.phi(quantity = "Angle", unit = "rad",
↳displayUnit = "deg") "External support angle (= flange.phi)";

```

(continues on next page)

(continued from previous page)

```

protected Real emf1.internalSupport.flange.phi(quantity = "Angle", unit = "rad",
↪displayUnit = "deg") "Absolute rotation angle of flange";
protected Real emf1.internalSupport.flange.tau(quantity = "Torque", unit = "N.m
↪") "Cut torque in the flange";
protected parameter Real emf1.fixed.phi0(quantity = "Angle", unit = "rad",
↪displayUnit = "deg") = 0.0 "Fixed offset angle of housing";
protected Real emf1.fixed.flange.phi(quantity = "Angle", unit = "rad",
↪displayUnit = "deg") "Absolute rotation angle of flange";
protected Real emf1.fixed.flange.tau(quantity = "Torque", unit = "N.m") "Cut
↪torque in the flange";
Real step1.y "Connector of Real output signal";
parameter Real step1.offset = 0.0 "Offset of output signal y";
parameter Real step1.startTime(quantity = "Time", unit = "s") = 0.0 "Output y =
↪offset for time < startTime";
parameter Real step1.height = 1.0 "Height of step";
Real signalVoltage1.p.v(quantity = "ElectricPotential", unit = "V") "Potential
↪at the pin";
Real signalVoltage1.p.i(quantity = "ElectricCurrent", unit = "A") "Current
↪flowing into the pin";
Real signalVoltage1.n.v(quantity = "ElectricPotential", unit = "V") "Potential
↪at the pin";
Real signalVoltage1.n.i(quantity = "ElectricCurrent", unit = "A") "Current
↪flowing into the pin";
Real signalVoltage1.v(unit = "V") "Voltage between pin p and n (= p.v - n.v) as
↪input signal";
Real signalVoltage1.i(quantity = "ElectricCurrent", unit = "A") "Current flowing
↪from pin p to pin n";
equation
  assert(1.0 + resistor1.alpha * (resistor1.T_heatPort - resistor1.T_ref) >= 1e-15,
↪ "Temperature outside scope of model!");
  resistor1.R_actual = resistor1.R * (1.0 + resistor1.alpha * (resistor1.T_
↪heatPort - resistor1.T_ref));
  resistor1.i = resistor1.R_actual * resistor1.v;
  resistor1.LossPower = resistor1.v * resistor1.i;
  resistor1.v = resistor1.p.v - resistor1.n.v;
  0.0 = resistor1.p.i + resistor1.n.i;
  resistor1.i = resistor1.p.i;
  resistor1.T_heatPort = resistor1.T;
  inductor1.L * der(inductor1.i) = inductor1.v;
  inductor1.v = inductor1.p.v - inductor1.n.v;
  0.0 = inductor1.p.i + inductor1.n.i;
  inductor1.i = inductor1.p.i;
  ground1.p.v = 0.0;
  load.phi = load.flange_a.phi;
  load.phi = load.flange_b.phi;
  load.w = der(load.phi);
  load.a = der(load.w);
  load.J * load.a = load.flange_a.tau + load.flange_b.tau;
  emf1.internalSupport.flange.tau = emf1.internalSupport.tau;
  emf1.internalSupport.flange.phi = emf1.internalSupport.phi;
  emf1.fixed.flange.phi = emf1.fixed.phi0;
  emf1.v = emf1.p.v - emf1.n.v;
  0.0 = emf1.p.i + emf1.n.i;
  emf1.i = emf1.p.i;
  emf1.phi = emf1.flange.phi - emf1.internalSupport.phi;
  emf1.w = der(emf1.phi);
  emf1.k * emf1.w = emf1.v;
  emf1.tau = (-emf1.k) * emf1.i;
  emf1.tauElectrical = -emf1.tau;
  emf1.tau = emf1.flange.tau;
  step1.y = step1.offset + (if time < step1.startTime then 0.0 else step1.height);

```

(continues on next page)

(continued from previous page)

```
signalVoltage1.v = signalVoltage1.p.v - signalVoltage1.n.v;
0.0 = signalVoltage1.p.i + signalVoltage1.n.i;
signalVoltage1.i = signalVoltage1.p.i;
resistor1.p.i + signalVoltage1.p.i = 0.0;
resistor1.n.i + inductor1.p.i = 0.0;
inductor1.n.i + emf1.p.i = 0.0;
ground1.p.i + emf1.n.i + signalVoltage1.n.i = 0.0;
load.flange_a.tau + emf1.flange.tau = 0.0;
load.flange_b.tau = 0.0;
emf1.fixed.flange.tau + emf1.internalSupport.flange.tau = 0.0;
emf1.fixed.flange.phi = emf1.internalSupport.flange.phi;
signalVoltage1.v = step1.y;
resistor1.p.v = signalVoltage1.p.v;
inductor1.p.v = resistor1.n.v;
emf1.p.v = inductor1.n.v;
emf1.flange.phi = load.flange_a.phi;
emf1.n.v = ground1.p.v;
emf1.n.v = signalVoltage1.n.v;
end dcmotor;
```

Note:

Notification: dcmotor requested package Modelica of version 3.2.2. Modelica 3.2.3 is used instead which states that it is fully compatible without conversion script needed.

We plot part of the simulated result:

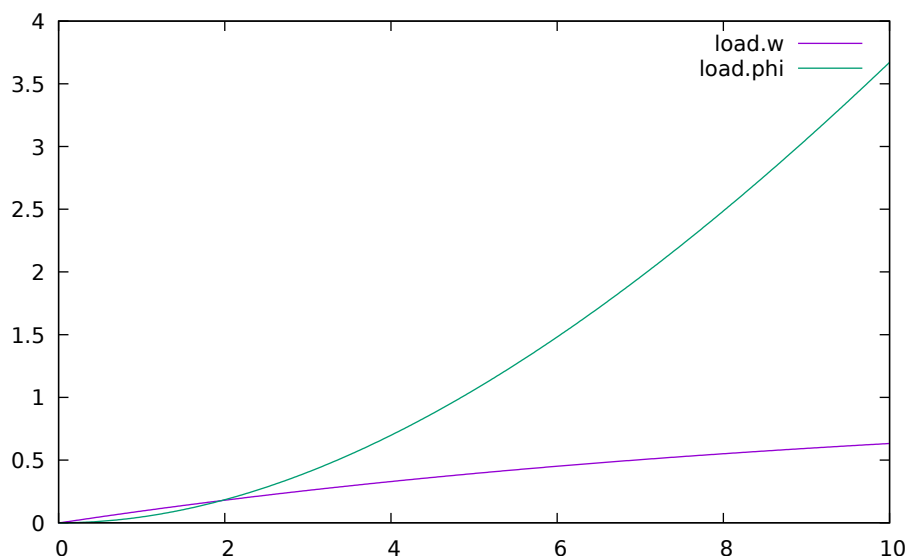

Figure 1.2: Rotation and rotational velocity of the DC motor

1.2.6 The val() function

The `val(variableName,time)` scripction function can be used to retrieve the interpolated value of a simulation result variable at a certain point in the simulation time, see usage in the BouncingBall simulation below.

1.2.7 BouncingBall and Switch Models

We load and simulate the BouncingBall example containing when-equations and if-expressions (the Modelica keywords have been bold-faced by hand for better readability):

```
>>> loadFile(getInstallationDirectoryPath() + "/share/doc/omc/testmodels/
↳BouncingBall.mo")
true
```

```
>>> list(BouncingBall)
model BouncingBall
  parameter Real e = 0.7 "coefficient of restitution";
  parameter Real g = 9.81 "gravity acceleration";
  Real h(fixed = true, start = 1) "height of ball";
  Real v(fixed = true) "velocity of ball";
  Boolean flying(fixed = true, start = true) "true, if ball is flying";
  Boolean impact;
  Real v_new(fixed = true);
  Integer foo;
equation
  impact = h <= 0.0;
  foo = if impact then 1 else 2;
  der(v) = if flying then -g else 0;
  der(h) = v;
  when {h <= 0.0 and v <= 0.0, impact} then
    v_new = if edge(impact) then -e * pre(v) else 0;
    flying = v_new > 0;
    reinit(v, v_new);
  end when;
end BouncingBall;
```

Instead of just giving a simulate and plot command, we perform a runScript command on a .mos (Modelica script) file sim_BouncingBall.mos that contains these commands:

```
>>> writeFile("sim_BouncingBall.mos", "
  loadFile(getInstallationDirectoryPath() + \" /share/doc/omc/testmodels/
↳BouncingBall.mo\");
  simulate(BouncingBall, stopTime=3.0);
  /* plot({h,flying}); */
")
true
>>> runScript("sim_BouncingBall.mos")
true
record SimulationResult
  resultFile = \"«DOCHOME»/BouncingBall_res.mat\",
  simulationOptions = \"startTime = 0.0, stopTime = 3.0, numberOfIntervals = 500,
↳ tolerance = 1e-06, method = 'dassl', fileNamePrefix = 'BouncingBall', options =
↳'', outputFormat = 'mat', variableFilter = '.*', cflags = '', simflags = ''\",
  messages = \"LOG_SUCCESS      | info      | The initialization finished_
↳successfully without homotopy method.
LOG_SUCCESS      | info      | The simulation finished successfully.
\",
  timeFrontend = 0.005512317,
  timeBackend = 0.004095828,
  timeSimCode = 0.001252571,
  timeTemplates = 0.022537003,
```

(continues on next page)

(continued from previous page)

```

timeCompile = 0.5461883360000001,
timeSimulation = 0.023216338,
timeTotal = 0.602899967
end SimulationResult;
"

```

```

model Switch
  Real v;
  Real i;
  Real il;
  Real itot;
  Boolean open;
equation
  itot = i + il;
  if open then
    v = 0;
  else
    i = 0;
  end if;
  1 - il = 0;
  1 - v - i = 0;
  open = time >= 0.5;
end Switch;

```

```

>>> simulate(Switch, startTime=0, stopTime=1)
record SimulationResult
  resultFile = "«DOCHOME»/Switch_res.mat",
  simulationOptions = "startTime = 0.0, stopTime = 1.0, numberOfIntervals = 500,
↳tolerance = 1e-06, method = 'dassl', fileNamePrefix = 'Switch', options = '',
↳outputFormat = 'mat', variableFilter = '.*', cflags = '', simflags = '',
  messages = "LOG_SUCCESS | info | The initialization finished,
↳successfully without homotopy method.
LOG_SUCCESS | info | The simulation finished successfully.
",
  timeFrontend = 0.005825004,
  timeBackend = 0.0054839330000000001,
  timeSimCode = 0.001025805,
  timeTemplates = 0.003756992,
  timeCompile = 0.43387608000000001,
  timeSimulation = 0.020758105,
  timeTotal = 0.470827549
end SimulationResult;

```

Retrieve the value of itot at time=0 using the val(variableName, time) function:

```

>>> val(itot,0)
1.0

```

Plot itot and open:

We note that the variable open switches from false (0) to true (1), causing itot to increase from 1.0 to 2.0.

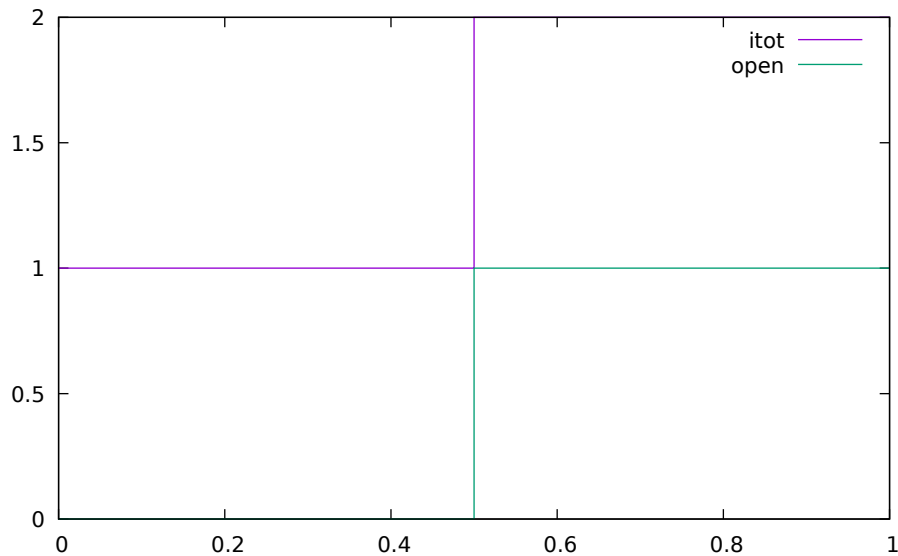

Figure 1.3: Plot when the switch opens

1.2.8 Clear All Models

Now, first clear all loaded libraries and models:

```
>>> clear()
true
```

List the loaded models – nothing left:

```
>>> list()
""
```

1.2.9 VanDerPol Model and Parametric Plot

We load another model, the VanDerPol model (or via the menu File->Load Model):

```
>>> loadFile(getInstallationDirectoryPath() + "/share/doc/omc/testmodels/VanDerPol.
↳mo")
true
```

It is simulated:

```
>>> simulate(VanDerPol, stopTime=80)
record SimulationResult
  resultFile = "«DOCHOME»/VanDerPol_res.mat",
  simulationOptions = "startTime = 0.0, stopTime = 80.0, numberOfIntervals = 500,
↳ tolerance = 1e-06, method = 'dassl', fileNamePrefix = 'VanDerPol', options = '',
↳ outputFormat = 'mat', variableFilter = '.*', cflags = '', simflags = '',
  messages = "LOG_SUCCESS      | info      | The initialization finished_
↳successfully without homotopy method.
LOG_SUCCESS      | info      | The simulation finished successfully.
",
  timeFrontend = 0.004492763,
  timeBackend = 0.001978453,
  timeSimCode = 0.000536026,
  timeTemplates = 0.003529455,
  timeCompile = 0.435150272,
```

(continues on next page)

(continued from previous page)

```
timeSimulation = 0.019822408,  
timeTotal = 0.46562308  
end SimulationResult;
```

It is plotted:

```
>>> plotParametric("x", "y")
```

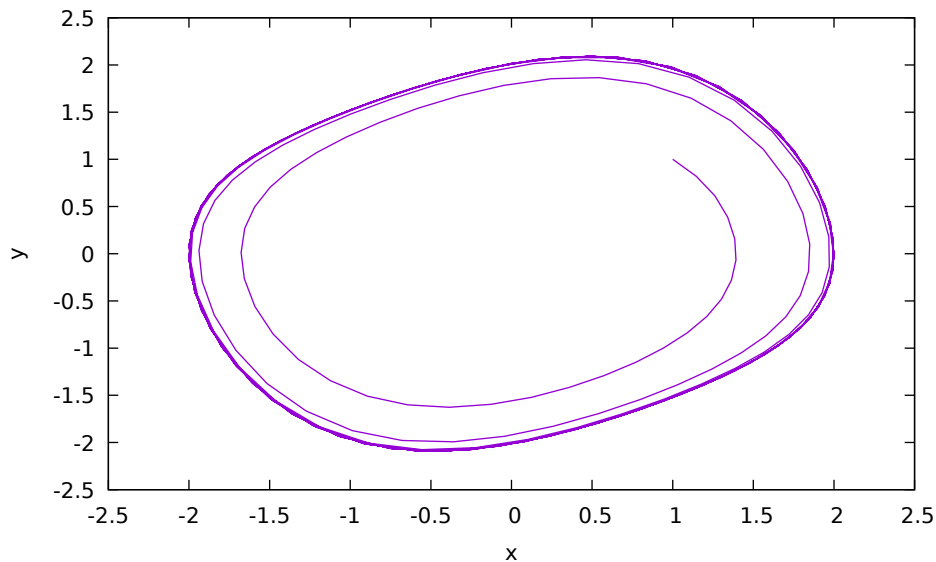

Figure 1.4: VanDerPol plotParametric(x,y)

Perform code instantiation to flat form of the VanDerPol model:

```
>>> instantiateModel(VanDerPol)  
class VanDerPol "Van der Pol oscillator model"  
  Real x(start = 1.0, fixed = true);  
  Real y(start = 1.0, fixed = true);  
  parameter Real lambda = 0.3;  
equation  
  der(x) = y;  
  der(y) = lambda * (1.0 - x ^ 2.0) * y - x;  
end VanDerPol;
```

1.2.10 Using Japanese or Chinese Characters

Japanese, Chinese, and other kinds of UniCode characters can be used within quoted (single quote) identifiers, see for example the variable name to the right in the plot below:



1.2.11 Scripting with For-Loops, While-Loops, and If-Statements

A simple summing integer loop (using multi-line input without evaluation at each line into OMSHELL requires copy-paste as one operation from another document):

```
>>> k := 0;
>>> for i in 1:1000 loop
  k := k + i;
end for;
>>> k
500500
```

A nested loop summing reals and integers:

```
>>> g := 0.0;
>>> h := 5;
>>> for i in {23.0,77.12,88.23} loop
  for j in i:0.5:(i+1) loop
    g := g + j;
    g := g + h / 2;
  end for;
  h := h + g;
end for;
```

By putting two (or more) variables or assignment statements separated by semicolon(s), ending with a variable, one can observe more than one variable value:

```
>>> h; g
1997.45
1479.09
```

A for-loop with vector traversal and concatenation of string elements:

```
>>> i:="";
>>> lst := {"Here ", "are ", "some ", "strings."};
>>> s := "";
>>> for i in lst loop
```

(continues on next page)

(continued from previous page)

```
s := s + i;
end for;
>>> s
"Here are some strings."
```

Normal while-loop with concatenation of 10 "abc " strings:

```
>>> s:="";
>>> i:=1;
>>> while i<=10 loop
  s:="abc "+s;
  i:=i+1;
end while;
>>> s
"abc abc abc abc abc abc abc abc abc abc "
```

A simple if-statement. By putting the variable last, after the semicolon, its value is returned after evaluation:

```
>>> if 5>2 then a := 77; end if; a
77
```

An if-then-else statement with elseif:

```
>>> if false then
  a := 5;
elseif a > 50 then
  b:= "test"; a:= 100;
else
  a:=34;
end if;
```

Take a look at the variables a and b:

```
>>> a;b
100
"test"
```

1.2.12 Variables, Functions, and Types of Variables

Assign a vector to a variable:

```
>>> a:=1:5
{1, 2, 3, 4, 5}
```

Type in a function:

```
function mySqr
  input Real x;
  output Real y;
algorithm
  y:=x*x;
end mySqr;
```

Call the function:

```
>>> b:=mySqr(2)
4.0
```

Look at the value of variable a:

```
>>> a
{1, 2, 3, 4, 5}
```

Look at the type of a:

```
>>> typeof(a)
"Integer[5]"
```

Retrieve the type of b:

```
>>> typeof(b)
"Real"
```

What is the type of mySqr? Cannot currently be handled.

```
>>> typeof(mySqr)
```

List the available variables:

```
>>> listVariables()
{b, a, s, lst, i, h, g, k, currentSimulationResult}
```

Clear again:

```
>>> clear()
true
```

1.2.13 Getting Information about Error Cause

Call the function `getErrorString()` in order to get more information about the error cause after a simulation failure:

```
>>> getErrorString()
""
```

1.2.14 Alternative Simulation Output Formats

There are several output format possibilities, with `mat` being the default. `plt` and `mat` are the only formats that allow you to use the `val()` or `plot()` functions after a simulation. Compared to the speed of `plt`, `mat` is roughly 5 times faster for small files, and scales better for larger files due to being a binary format. The `csv` format is roughly twice as fast as `plt` on data-heavy simulations. The `plt` format allocates all output data in RAM during simulation, which means that simulations may fail due to applications only being able to address 4GB of memory on 32-bit platforms. `Empty` does no output at all and should be by far the fastest. The `csv` and `plt` formats are suitable when using an external script or tools like `gnuplot` to generate plots or process data. The `mat` format can be post-processed in [MATLAB](#) or [Octave](#).

```
>>> simulate(... , outputFormat="mat")
>>> simulate(... , outputFormat="csv")
>>> simulate(... , outputFormat="plt")
>>> simulate(... , outputFormat="empty")
```

It is also possible to specify which variables should be present in the result-file. This is done by using [POSIX Extended Regular Expressions](#). The given expression must match the full variable name (`^` and `$` symbols are automatically added to the given regular expression).

// Default, match everything

```
>>> simulate(... , variableFilter=".*")
```

```
// match indices of variable myVar that only contain the numbers using combinations
// of the letters 1 through 3
```

```
>>> simulate(... , variableFilter="myVar\\\[ [1-3]* \\\\"]")
```

```
// match x or y or z
```

```
>>> simulate(... , variableFilter="x|y|z")
```

1.2.15 Using External Functions

See Chapter *Interoperability – C and Python* for more information about calling functions in other programming languages.

1.2.16 Using Parallel Simulation via OpenMP Multi-Core Support

Faster simulations on multi-core computers can be obtained by using a new OpenModelica feature that automatically partitions the system of equations and schedules the parts for execution on different cores using shared-memory OpenMP based execution. The speedup obtained is dependent on the model structure, whether the system of equations can be partitioned well. This version in the current OpenModelica release is an experimental version without load balancing. The following command, not yet available from the OpenModelica GUI, will run a parallel simulation on a model:

```
>>> omc -d=openmp model.mo
```

1.2.17 Loading Specific Library Version

There exist many different versions of Modelica libraries which are not compatible. It is possible to keep multiple versions of the same library stored in the directory given by calling `getModelicaPath()`. By calling `loadModel(Modelica, {"3.2"})`, OpenModelica will search for a directory called "Modelica 3.2" or a file called "Modelica 3.2.mo". It is possible to give several library versions to search for, giving preference for a pre-release version of a library if it is installed. If the searched version is "default", the priority is: no version name (Modelica), main release version (Modelica 3.1), pre-release version (Modelica 3.1Beta 1) and unordered versions (Modelica Special Release).

The `loadModel` command will also look at the `uses` annotation of the top-level class after it has been loaded. Given the following package, Complex 1.0 and ModelicaServices 1.1 will also be loaded into the AST automatically.

```
package Modelica
  annotation (uses (Complex (version="1.0"),
    ModelicaServices (version="1.1")));
end Modelica;
```

```
>>> clear()
true
```

Packages will also be loaded if a model has a `uses`-annotation:

```
model M
  annotation (uses (Modelica (version="3.2.1")));
end M;
```

```
>>> instantiateModel (M)
class M
end M;
```

Note:

Notification: Automatically loaded package Modelica 3.2.1 due to uses annotation.

Notification: Automatically loaded package Complex 3.2.1 due to uses annotation.

Notification: Automatically loaded package ModelicaServices 3.2.1 due to uses annotation.

Packages will also be loaded by looking at the first identifier in the path:

```
>>> instantiateModel(Modelica.Electrical.Analog.Basic.Ground)
class Modelica.Electrical.Analog.Basic.Ground "Ground node"
  Real p.v(quantity = "ElectricPotential", unit = "V") "Potential at the pin";
  Real p.i(quantity = "ElectricCurrent", unit = "A") "Current flowing into the pin
↔";
equation
  p.v = 0.0;
  p.i = 0.0;
end Modelica.Electrical.Analog.Basic.Ground;
```

Note:

Notification: Automatically loaded package Complex 3.2.3 due to uses annotation.

Notification: Automatically loaded package ModelicaServices 3.2.3 due to uses annotation.

Notification: Automatically loaded package Modelica default due to uses annotation.

1.2.18 Calling the Model Query and Manipulation API

In the OpenModelica System Documentation, an external API (application programming interface) is described which returns information about models and/or allows manipulation of models. Calls to these functions can be done interactively as below, but more typically by program clients to the OpenModelica Compiler (OMC) server. Current examples of such clients are the OpenModelica MDT Eclipse plugin, OMNotebook, the OMedit graphic model editor, etc. This API is untyped for performance reasons, i.e., no type checking and minimal error checking is done on the calls. The results of a call is returned as a text string in Modelica syntax form, which the client has to parse. An example parser in C++ is available in the OMNotebook source code, whereas another example parser in Java is available in the MDT Eclipse plugin.

Below we show a few calls on the previously simulated BouncingBall model. The full documentation on this API is available in the system documentation. First we load and list the model again to show its structure:

```
>>> loadFile(getInstallationDirectoryPath() + "/share/doc/omc/testmodels/
↔BouncingBall.mo");
>>> list(BouncingBall)
model BouncingBall
  parameter Real e = 0.7 "coefficient of restitution";
  parameter Real g = 9.81 "gravity acceleration";
  Real h(fixed = true, start = 1) "height of ball";
  Real v(fixed = true) "velocity of ball";
  Boolean flying(fixed = true, start = true) "true, if ball is flying";
  Boolean impact;
  Real v_new(fixed = true);
  Integer foo;
equation
  impact = h <= 0.0;
  foo = if impact then 1 else 2;
  der(v) = if flying then -g else 0;
  der(h) = v;
  when {h <= 0.0 and v <= 0.0, impact} then
```

(continues on next page)

(continued from previous page)

```

v_new = if edge(impact) then -e * pre(v) else 0;
flying = v_new > 0;
reinit(v, v_new);
end when;
end BouncingBall;

```

Different kinds of calls with returned results:

```

>>> getClassRestriction(BouncingBall)
"model"
>>> getClassInformation(BouncingBall)
("model", "", false, false, false, "/var/lib/jenkins2/ws/OpenModelica_maintenance_v1.16/
↳ build/share/doc/omc/testmodels/BouncingBall.mo", false, 1, 1, 23, 17, {}, false, false, "
↳ ", "", false, "")
>>> isFunction(BouncingBall)
false
>>> existClass(BouncingBall)
true
>>> getComponents(BouncingBall)
{{Real,e,"coefficient of restitution", "public", false, false, false, false,
↳ "parameter", "none", "unspecified", {}}, {Real,g,"gravity acceleration", "public",
↳ false, false, false, false, "parameter", "none", "unspecified", {}}, {Real,h,
↳ "height of ball", "public", false, false, false, false, "unspecified", "none",
↳ "unspecified", {}}, {Real,v,"velocity of ball", "public", false, false, false,
↳ false, "unspecified", "none", "unspecified", {}}, {Boolean,flying,"true, if ball
↳ is flying", "public", false, false, false, false, "unspecified", "none",
↳ "unspecified", {}}, {Boolean,impact, "", "public", false, false, false, false,
↳ "unspecified", "none", "unspecified", {}}, {Real,v_new, "", "public", false, false,
↳ false, false, "unspecified", "none", "unspecified", {}}, {Integer,foo, "", "public",
↳ false, false, false, false, "unspecified", "none", "unspecified", {}}}
>>> getConnectionCount(BouncingBall)
0
>>> getInheritanceCount(BouncingBall)
0
>>> getComponentModifierValue(BouncingBall,e)
"0.7"
>>> getComponentModifierNames(BouncingBall,"e")
{}
>>> getClassRestriction(BouncingBall)
"model"
>>> getVersion() // Version of the currently running OMC
"OMCCompiler v1.16.0-dev.beta3.22+gfeadc57b32"

```

1.2.19 Quit OpenModelica

Leave and quit OpenModelica:

```
>>> quit()
```

1.2.20 Dump XML Representation

The command `dumpXMLDAE` dumps an XML representation of a model, according to several optional parameters.

```
dumpXMLDAE(modelname[,asInSimulationCode=<Boolean>]      [,filePrefix=<String>]      [,storeInTemp=<Boolean>] [,addMathMLCode =<Boolean>])
```

This command dumps the mathematical representation of a model using an XML representation, with optional parameters. In particular, `asInSimulationCode` defines where to stop in the translation process (before dumping the model), the other options are relative to the file storage: `filePrefix` for specifying a different name and `storeInTemp` to use the temporary directory. The optional parameter `addMathMLCode` gives the possibility to don't print the MathML code within the xml file, to make it more readable. Usage is trivial, just: `addMathMLCode=true/false` (default value is false).

1.2.21 Dump Matlab Representation

The command `exportDAEtoMatlab` dumps an XML representation of a model, according to several optional parameters.

```
exportDAEtoMatlab(modelname);
```

This command dumps the mathematical representation of a model using a Matlab representation. Example:

```
>>> loadFile(getInstallationDirectoryPath() + "/share/doc/omc/testmodels/
↳BouncingBall.mo")
true
>>> exportDAEtoMatlab(BouncingBall)
"The equation system was dumped to Matlab file:BouncingBall_imatrix.m"
```

```
% Adjacency Matrix
% =====
% number of rows: 6
IM={{3,6},{1,{ 'if', 'true', '==' {3},{},}},{{ 'if', 'true', '==' {4},{},}},{5},{2,{ 'if
↳', 'edge(impact)' {3},{5},}},{4,2}};
VL = {'foo','v_new','impact','flying','v','h'};

EqStr = {'impact = h <= 0.0;','foo = if impact then 1 else 2;','der(v) = if flying
↳then -g else 0.0;','der(h) = v;','when {h <= 0.0 and v <= 0.0, impact} then v_
↳new = if edge(impact) then (-e) * pre(v) else 0.0; end when;','when {h <= 0.0
↳and v <= 0.0, impact} then flying = v_new > 0.0; end when;'};

OldEqStr={'class BouncingBall',' parameter Real e = 0.7 "coefficient of
↳restitution";',' parameter Real g = 9.81 "gravity acceleration";',' Real
↳h(start = 1.0, fixed = true) "height of ball";',' Real v(fixed = true)
↳"velocity of ball";',' Boolean flying(start = true, fixed = true) "true, if
↳ball is flying";',' Boolean impact;',' Real v_new(fixed = true);',' Integer
↳foo;','equation',' impact = h <= 0.0;',' foo = if impact then 1 else 2;','
↳der(v) = if flying then -g else 0.0;',' der(h) = v;',' when {h <= 0.0 and v <=
↳0.0, impact} then',' v_new = if edge(impact) then (-e) * pre(v) else 0.0;','
↳ flying = v_new > 0.0;',' reinit(v, v_new);',' end when;','end BouncingBall;
↳',' '};
```

1.3 Summary of Commands for the Interactive Session Handler

The following is the complete list of commands currently available in the interactive session handler.

`simulate(modelname)` Translate a model named *modelname* and simulate it.

`simulate(modelname[,startTime=<Real>][,stopTime=<Real>][,numberOfIntervals=<Integer>][,outputInterval=<Real>][,method=<String>][,tolerance=<Real>][,fixedStepSize=<Real>][,outputFormat=<String>])` Translate and simulate a model, with optional start time, stop time, and optional number of simulation intervals or steps for which the simulation results will be computed. More intervals will give higher time resolution, but occupy more space and take longer to compute. The default number of intervals is 500. It is possible to choose solving method, default is “dassl”, “euler” and “rungekutta” are also available. Output format “mat” is default. “plt” and “mat” (MATLAB) are the only ones that work with the `val()` command, “csv” (comma separated values) and “empty” (no output) are also available (see section *Alternative Simulation Output Formats*).

`plot(vars)` Plot the variables given as a vector or a scalar, e.g. `plot({x1,x2})` or `plot(x1)`.

`plotParametric(var1, var2)` Plot *var2* relative to *var1* from the most recently simulated model, e.g. `plotParametric(x,y)`.

`cd()` Return the current directory.

`cd(dir)` Change directory to the directory given as string.

`clear()` Clear all loaded definitions.

`clearVariables()` Clear all defined variables.

`dumpXMLDAE(modelname, ...)` Dumps an XML representation of a model, according to several optional parameters.

`exportDAEtoMatlab(name)` Dumps a Matlab representation of a model.

`instantiateModel(modelname)` Performs code instantiation of a model/class and return a string containing the flat class definition.

`list()` Return a string containing all loaded class definitions.

`list(modelname)` Return a string containing the class definition of the named class.

`listVariables()` Return a vector of the names of the currently defined variables.

`loadModel(classname)` Load model or package of name *classname* from the path indicated by the environment variable `OPENMODELICALIBRARY`.

`loadFile(str)` Load Modelica file (.mo) with name given as string argument *str*.

`readFile(str)` Load file given as string *str* and return a string containing the file content.

`runScript(str)` Execute script file with file name given as string argument *str*.

`system(str)` Execute *str* as a system(shell) command in the operating system; return integer success value. Output into stdout from a shell command is put into the console window.

`timing(expr)` Evaluate expression *expr* and return the number of seconds (elapsed time) the evaluation took.

`typeof(variable)` Return the type of the *variable* as a string.

`saveModel(str,modelname)` Save the model/class with name *modelname* in the file given by the string argument *str*.

`val(variable,timePoint)` Return the (interpolated) value of the *variable* at time *timePoint*.

`help()` Print this helptext (returned as a string).

`quit()` Leave and quit the OpenModelica environment

1.4 Running the compiler from command line

The OpenModelica compiler can also be used from command line, in Windows cmd.exe or a Unix shell. The following examples assume omc is on the PATH; if it is not, you can run C:\OpenModelica 1.16.0\build\bin\omc.exe or similar (depending on where you installed OpenModelica).

1.4.1 Example Session 1 – obtaining information about command line parameters

```
$ omc --help
OpenModelica Compiler OMCompiler v1.16.0-dev.beta3.22+gfeadc57b32
Copyright © 2019 Open Source Modelica Consortium (OSMC)
Distributed under OMSC-PL and GPL, see www.openmodelica.org

Usage: omc [Options] (Model.mo | Script.mos) [Libraries | .mo-files]
* Libraries: Fully qualified names of libraries to load before processing Model or
↳Script.
...
Documentation is available in the built-in package OpenModelica.Scripting or
online <https://build.openmodelica.org/Documentation/OpenModelica.Scripting.html>.
```

1.4.2 Example Session 2 – create an TestModel.mo file and run omc on it

```
model TestModel
  parameter Real x = 1;
end TestModel;
```

```
$ omc TestModel.mo
class TestModel
  parameter Real x = 1.0;
end TestModel;
```

1.4.3 Example Session 3 – create a mos-script and run omc on it

```
loadModel(Modelica);
getErrorString();
simulate(Modelica.Mechanics.MultiBody.Examples.Elementary.Pendulum);
getErrorString();
```

```
$ omc TestScript.mos
true
""
record SimulationResult
  resultFile = "/var/lib/jenkins2/ws/OpenModelica_maintenance_v1.16/doc/
↳UsersGuide/source/Modelica.Mechanics.MultiBody.Examples.Elementary.Pendulum_res.
↳mat",
  simulationOptions = "startTime = 0.0, stopTime = 5.0, numberOfIntervals = 500,
↳tolerance = 1e-06, method = 'dassl', fileNamePrefix = 'Modelica.Mechanics.
↳MultiBody.Examples.Elementary.Pendulum', options = '', outputFormat = 'mat',
↳variableFilter = '.*', cflags = '', simflags = '',
  messages = "LOG_SUCCESS      | info      | The initialization finished
↳successfully without homotopy method.
LOG_SUCCESS      | info      | The simulation finished successfully.
",
  timeFrontend = 1.231100956,
```

(continues on next page)

(continued from previous page)

```
timeBackend = 0.934220795,  
timeSimCode = 0.067513527,  
timeTemplates = 0.163642766,  
timeCompile = 1.255080647,  
timeSimulation = 0.1241255,  
timeTotal = 3.7758856  
end SimulationResult;  
""
```

In order to obtain more information from the compiler one can use the command line options **--showErrorMessage**s **-d=failtrace** when running the compiler:

```
$ omc --showErrorMessage -d=failtrace TestScript.mos  
InstFunction.getRecordConstructorFunction failed for OpenModelica.Scripting.  
↳loadModel  
- Static.elabCrefSubs failed on: [top:<Prefix.NOPRE()>].<Prefix.NOPRE()>.Modelica_  
↳env: <global scope>  
- Static.elabCref failed: Modelica in env: <global scope>  
- Static.elabCrefSubs failed on: [top:<Prefix.NOPRE()>].<Prefix.NOPRE()>.Modelica_  
↳env: <global scope>  
...  
[/var/lib/jenkins1/ws/OpenModelica_maintenance_v1.16/OMCompiler/Compiler/BackEnd/  
↳ExpressionSolve.mo:216:9-216:210:writable] Error: Internal error Failed to solve_  
↳\"world.z_label.cylinders[3].r[1] = world.z_label.cylinders[2].r[1]\" w.r.t. \  
↳\"world.z_label.R_lines[2,1]\"  
[/var/lib/jenkins1/ws/OpenModelica_maintenance_v1.16/OMCompiler/Compiler/BackEnd/  
↳ExpressionSolve.mo:216:9-216:210:writable] Error: Internal error Failed to solve_  
↳\"world.z_label.cylinders[3].r[2] = world.z_label.cylinders[2].r[2]\" w.r.t. \  
↳\"world.z_label.R_lines[2,2]\"  
[/var/lib/jenkins1/ws/OpenModelica_maintenance_v1.16/OMCompiler/Compiler/BackEnd/  
↳ExpressionSolve.mo:216:9-216:210:writable] Error: Internal error Failed to solve_  
↳\"world.z_label.cylinders[3].r[3] = world.z_label.cylinders[2].r[3]\" w.r.t. \  
↳\"world.z_label.R_lines[2,3]\"  
"
```

OMEDIT – OPENMODELICA CONNECTION EDITOR

OMEdit – OpenModelica Connection Editor is the new Graphical User Interface for graphical model editing in OpenModelica. It is implemented in C++ using the Qt graphical user interface library and supports the Modelica Standard Library that is included in the latest OpenModelica installation. This chapter gives a brief introduction to OMEdit and also demonstrates how to create a DCMotor model using the editor.

OMEdit provides several user friendly features for creating, browsing, editing, and simulating models:

- *Modeling* – Easy model creation for Modelica models.
- *Pre-defined models* – Browsing the Modelica Standard library to access the provided models.
- *User defined models* – Users can create their own models for immediate usage and later reuse.
- *Component interfaces* – Smart connection editing for drawing and editing connections between model interfaces.
- *Simulation* – Subsystem for running simulations and specifying simulation parameters start and stop time, etc.
- *Plotting* – Interface to plot variables from simulated models.

2.1 Starting OMEdit

A splash screen similar to the one shown in [Figure 2.1](#) will appear indicating that it is starting OMEdit. The executable is found in different places depending on the platform (see below).

2.1.1 Microsoft Windows

OMEdit can be launched using the executable placed in `OpenModelicaInstallationDirectory/bin/OMEdit/OMEdit.exe`. Alternately, choose `OpenModelica > OpenModelica Connection Editor` from the start menu in Windows.

2.1.2 Linux

Start OMEdit by either selecting the corresponding menu application item or typing “**OMEdit**” at the shell or command prompt.

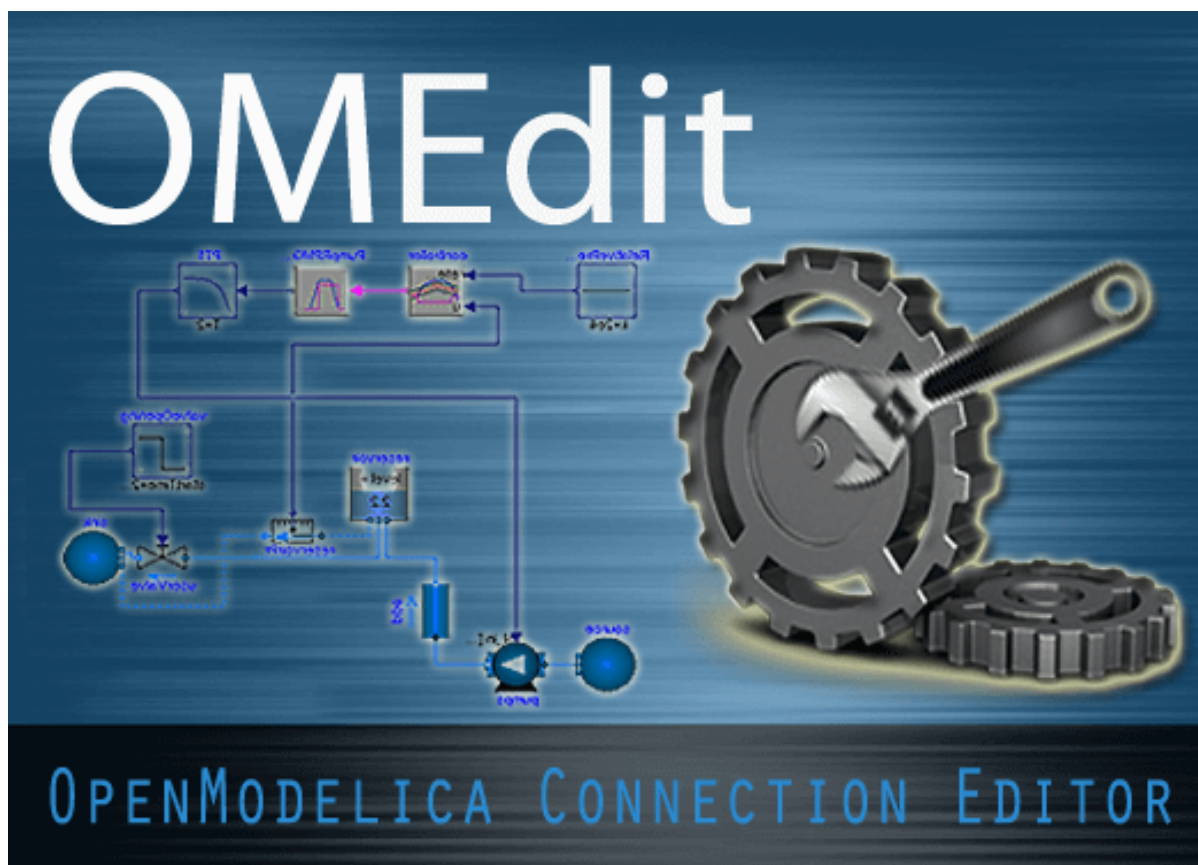

Figure 2.1: OMEdit Splash Screen.

2.1.3 Mac OS X

The default installation is `/Application/MacPorts/OMEdit.app`.

2.2 MainWindow & Browsers

The MainWindow contains several dockable browsers,

- Libraries Browser
- Documentation Browser
- Variables Browser
- Messages Browser

Figure 8.1 shows the MainWindow and browsers.

The default location of the browsers are shown in Figure 8.1. All browsers except for Message Browser can be docked into left or right column. The Messages Browser can be docked into top or bottom areas. If you want OMEdit to remember the new docked position of the browsers then you must enable Preserve User's GUI Customizations option, see section *General*.

2.2.1 Filter Classes

To filter a class click Edit > Filter Classes or press keyboard shortcut Ctrl+Shift+F. The loaded Modelica classes can be filtered by typing any part of the class name.

2.2.2 Libraries Browser

To view the Libraries Browser click View > Windows > Libraries Browser. Shows the list of loaded Modelica classes. Each item of the Libraries Browser has right click menu for easy manipulation and usage of the class. The classes are shown in a tree structure with name and icon. The protected classes are not shown by default. If you want to see the protected classes then you must enable the Show Protected Classes option, see section *General*.

2.2.3 Documentation Browser

Displays the HTML documentation of Modelica classes. It contains the navigation buttons for moving forward and backward. It also contains a WYSIWYG editor which allows writing class documentation in HTML format. To view the Documentation Browser click View > Windows > Documentation Browser.

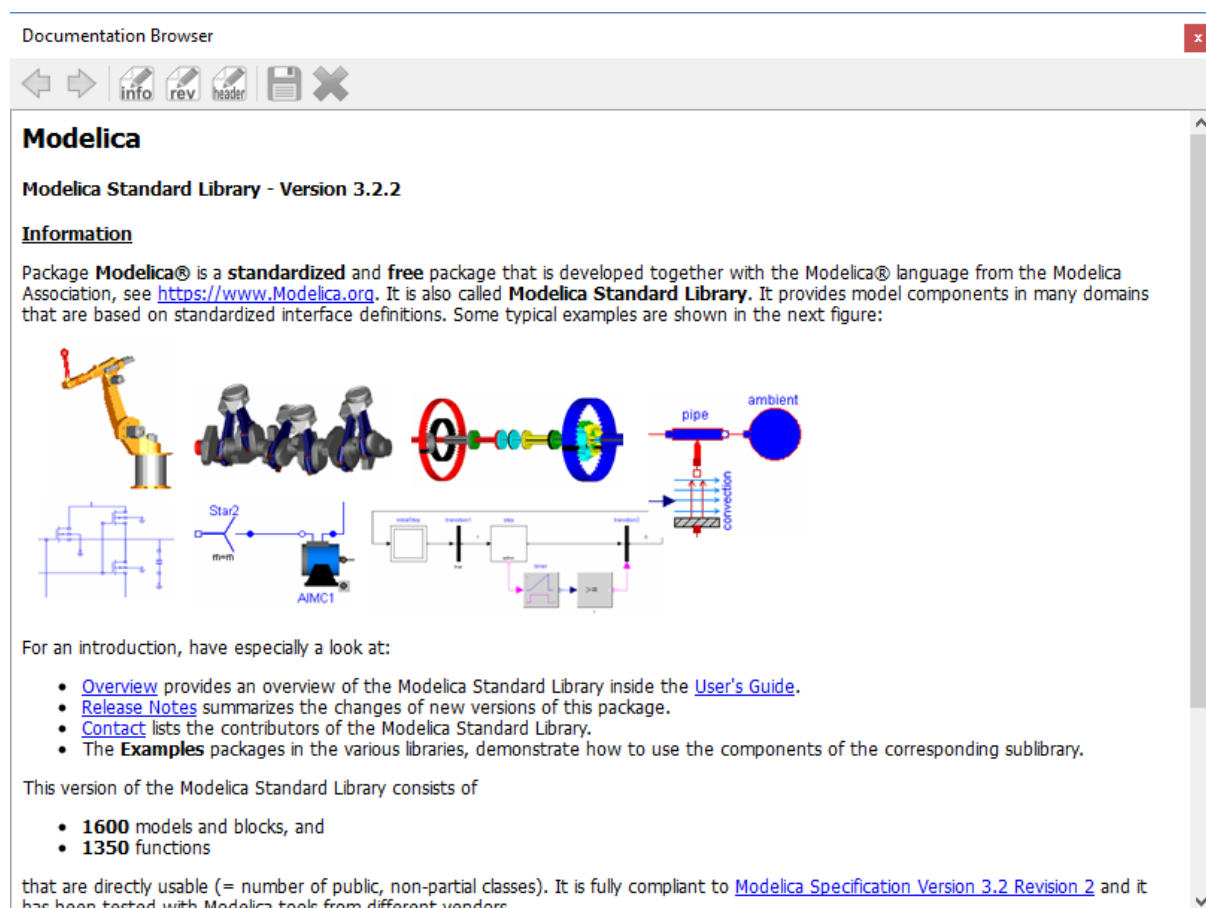

Figure 2.3: Documentation Browser.

2.2.4 Variables Browser

The class variables are structured in the form of the tree and are displayed in the Variables Browser. Each variable has a checkbox. Ticking the checkbox will plot the variable values. There is a find box on the top for filtering the variable in the tree. The filtering can be done using Regular Expression, Wildcard and Fixed String. The complete Variables Browser can be collapsed and expanded using the Collapse All and Expand All buttons.

The browser allows manipulation of changeable parameters for *Re-simulating a Model*. It also displays the unit and description of the variable.

The browser also contains the slider and animation buttons. These controls are used for variable graphics and schematic animation of models i.e., DynamicSelect annotation. They are also used for debugging of state machines. Open the *Diagram Window* for animation. It is only possible to animate one model at a time. This is achieved by marking the result file active in the Variables Browser. The animation only read the values from the active result file. It is possible to simulate several models. In that case, the user will see a list of result files in the Variables Browser. The user can switch between different result files by right clicking on the result file and selecting **Set Active** in the context menu.

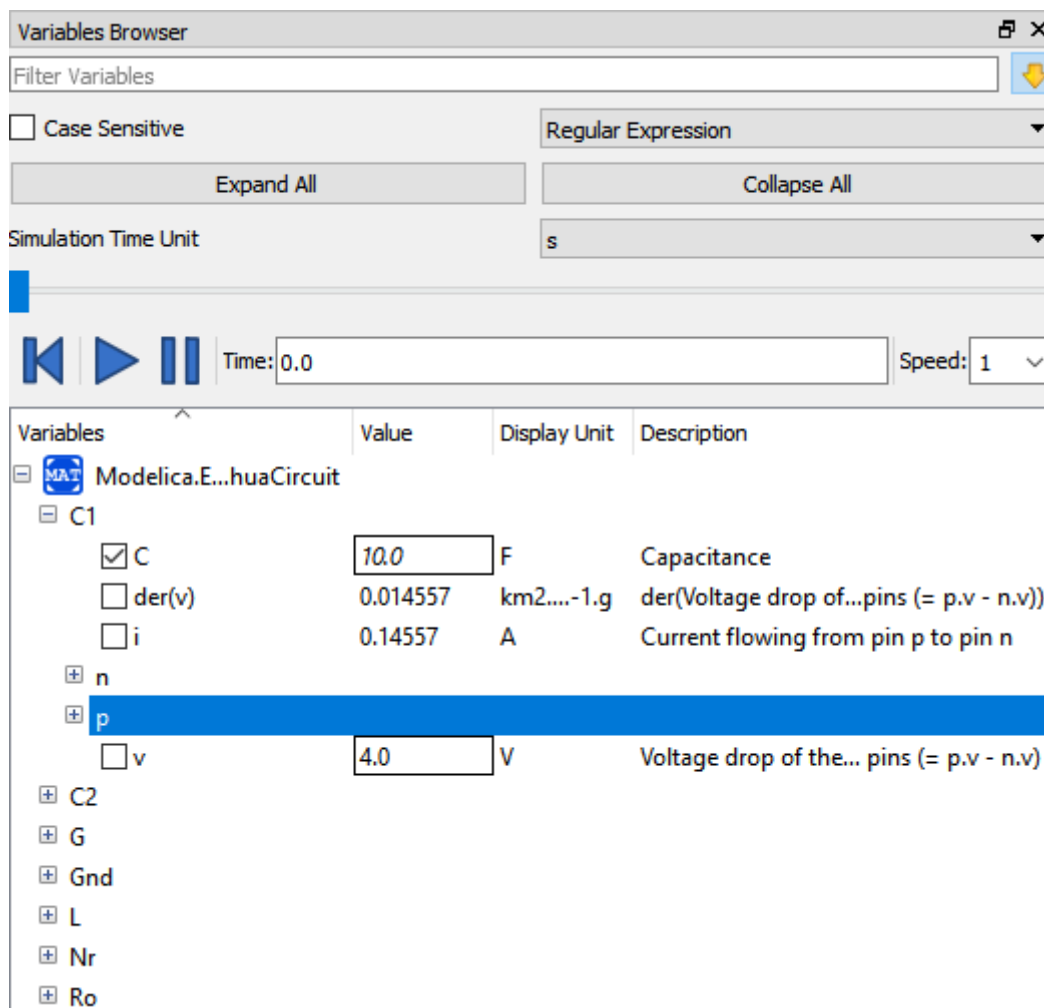

Figure 2.4: Variables Browser.

2.2.5 Messages Browser

Shows the list of errors. Following kinds of error can occur,

- Syntax
- Grammar
- Translation
- Symbolic
- Simulation
- Scripting

See section *Messages* for Messages Browser options.

2.3 Perspectives

The perspective tabs are located at the bottom right of the MainWindow:

- Welcome Perspective
- Modeling Perspective
- Plotting Perspective
- Debugging Perspective

2.3.1 Welcome Perspective

The Welcome Perspective shows the list of recent files and the list of latest news from <https://www.openmodelica.org>. See [Figure 2.5](#). The orientation of recent files and latest news can be horizontal or vertical. User is allowed to show/hide the latest news. See section *General*.

2.3.2 Modeling Perspective

The Modeling Perspective provides the interface where user can create and design their models. See [Figure 2.6](#).

The Modeling Perspective interface can be viewed in two different modes, the tabbed view and subwindow view, see section *General*.

2.3.3 Plotting Perspective

The Plotting Perspective shows the simulation results of the models. Plotting Perspective will automatically become active when the simulation of the model is finished successfully. It will also become active when user opens any of the OpenModelica's supported result file. Similar to Modeling Perspective this perspective can also be viewed in two different modes, the tabbed view and subwindow view, see section *General*.

2.3.4 Debugging Perspective

The application automatically switches to Debugging Perspective when user simulates the class with algorithmic debugger. The perspective shows the list of stack frames, breakpoints and variables.



Figure 2.5: OMEdit Welcome Perspective.

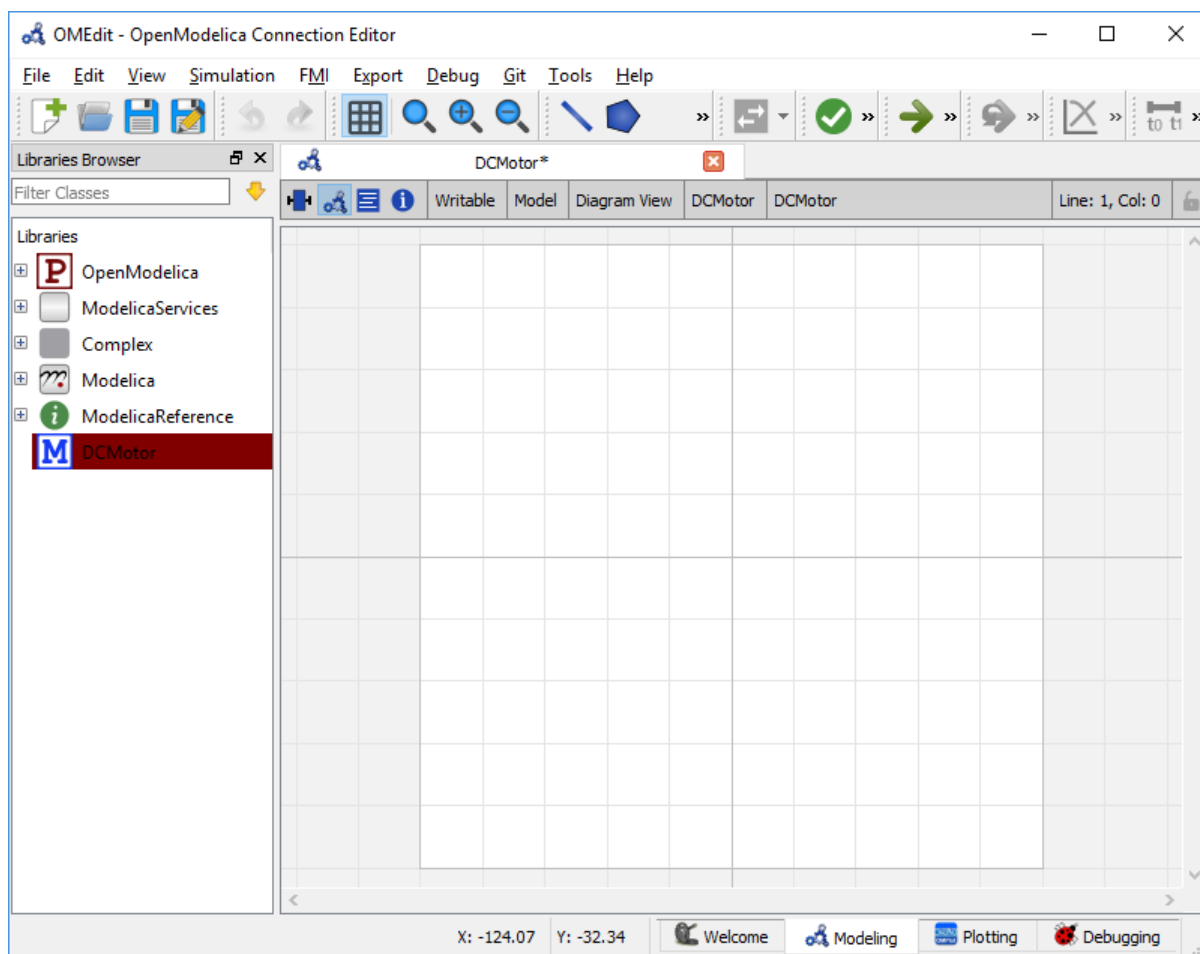

Figure 2.6: OMEdit Modeling Perspective.



Figure 2.7: OMEdit Plotting Perspective.

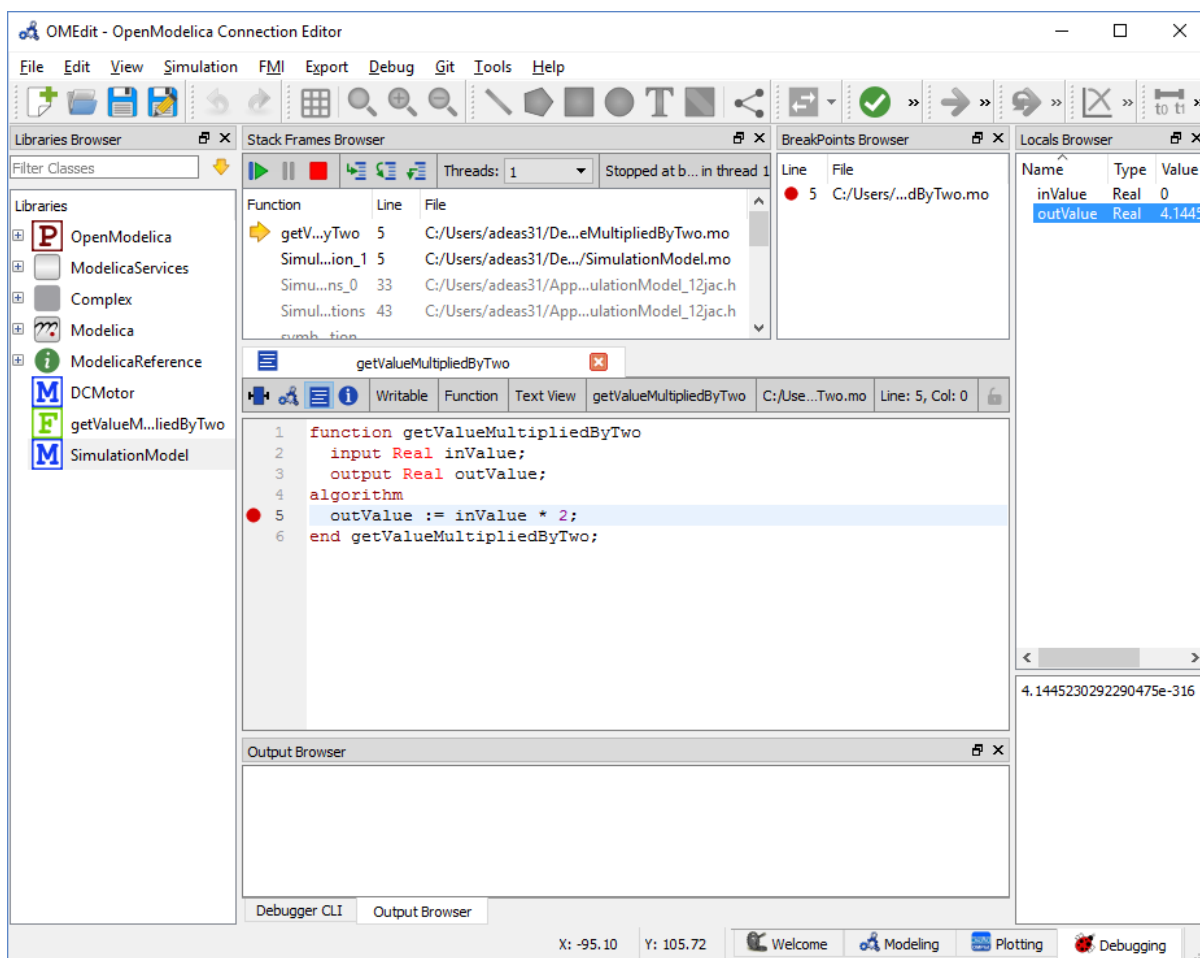

Figure 2.8: OMEdit Debugging Perspective.

2.4 File Menu

- *New Modelica Class* - Creates a new Modelica class.
- *Open Model/Library File(s)* - Opens the Modelica file or a library.
- *Open/Convert Modelica File(s) With Encoding* - Opens the Modelica file or a library with a specific encoding. It is also possible to convert to UTF-8.
- *Load Library* - Loads a Modelica library. Allows the user to select the library path assuming that the path contains a package.mo file.
- *Load Encrypted Library* - Loads an encrypted library. see *OpenModelica Encryption*
- *Open Result File(s)* - Opens a result file.
- *Open Transformations File* - Opens a transformational debugger file.
- *New Composite Model* - Creates a new composite model.
- *Open Composite Model(s)* - Loads an existing composite model.
- *Load External Model(s)* - Loads the external models that can be used within composite model.
- *Open Directory* - Loads the files of a directory recursively. The files are loaded as text files.
- *Save* - Saves the class.
- *Save As* - Save as the class.
- *Save Total* - Saves the class and all the classes it uses in a single file. The class and its dependencies can only be loaded later by using the *loadFile()* API function in a script. Allows third parties to reproduce an issue with a class without worrying about library dependencies.
- *Import*
 - *FMU* - Imports the FMU.
 - *FMU Model Description* - Imports the FMU model description.
 - *From OMNotbook* - Imports the Modelica models from OMNotebook.
 - *Ngspice netlist* - Imports the ngspice netlist to Modelica code.
- "Export"
 - *To Clipboard* - Exports the current model to clipboard.
 - *Image* - Exports the current model to image.
 - *FMU* - Exports the current model to FMU.
 - *Read-only Package* - Exports a zipped Modelica library with file extension .mol
 - *Encrypted Package* - Exports an encrypted package. see *OpenModelica Encryption*
 - *XML* - Exports the current model to a xml file.
 - *Figaro* - Exports the current model to Figaro.
 - *To OMNotebook* - Exports the current model to a OMNotebook file.
- *System Libraries* - Contains a list of system libraries.
- *Recent Files* - Contains a list of recent files.
- *Clear Recent Files* - Clears the list of recent files.
- *Print* - Prints the current model.
- *Quit* - Quit the OpenModelica Connection Editor.

2.5 Edit Menu

- *Undo* - Undoes the last change.
- *Redo* - Redoes the last undone change.
- *Filter Classes* - Filters the classes in Libraries Browser. see *Filter Classes*

2.6 View Menu

- *Toolbars* - Toggle visibility of toolbars.
- *Windows* - Toggle visibility of windows.
- *Close Window* - Closes the current model window.
- *Close All Windows* - Closes all the model windows.
- *Close All Windows But This* - Closes all the model windows except the current.
- *Cascade Windows* - Arranges all the child windows in a cascade pattern.
- *Tile Windows Horizontally* - Arranges all child windows in a horizontally tiled pattern.
- *Tile Windows Vertically* - Arranges all child windows in a vertically tiled pattern.
- *Toggle Tab/Sub-window View* - Switches between tab and subwindow view.
- *Grid Lines* - Toggle grid lines of the current model.
- *Reset Zoom* - Resets the zoom of the current model.
- *Zoom In* - Zoom in the current model.
- *Zoom Out* - Zoom out the current model.

2.7 Simulation Menu

- *Check Model* - Checks the current model.
- *Check All Models* - Checks all the models of a library.
- *Instantiate Model* - Instantiates the current model.
- *Simulation Setup* - Opens the simulation setup window.
- *Instantiate SSP Model* - Instantiates the current SSP model.
- *Simulate* - Simulates the current model.
- *Simulate with Transformational Debugger* - Simulates the current model and opens the transformational debugger.
- *Simulate with Algorithmic Debugger* - Simulates the current model and opens the algorithmic debugger.
- *Simulate with Animation* - Simulates the current model and open the animation.

2.8 Debug Menu

- *Debug Configurations* - Opens the debug configurations window.
- *Attach to Running Process* - Attaches the algorithmic debugger to a running process.

2.9 SSP Menu

- *New SSP Model* - Creates a new SSP model.
- *Open SSP Model(s)* - Opens the SSP model(s).
- *Add System* - Adds the system to a model.
- *Add/Edit Icon* - Add/Edit the system/submodel icon.
- *Delete Icon* - Deletes the system/submodel icon.
- *Add Connector* - Adds a connector to a system/submodel.
- *Add Bus* - Adds a bus to a system/submodel.
- *Add TLM Bus* - Adds a TLM bus to a system/submodel.
- *Add SubModel* - Adds a submodel to a system.

2.10 Sensitivity Optimization Menu

- *Run Sensitivity Analysis and Optimization* - Runs the sensitivity analysis and optimization.

2.11 Tools Menu

- *OpenModelica Compiler CLI* - Opens the OpenModelica Compiler command line interface window.
- *OpenModelica Command Prompt* - Opens the OpenModelica Command Prompt (Only available on Windows).
- *Open Working Directory* - Opens the current working directory.
- *Open Terminal* - Runs the terminal command set in *General*.
- *Options* - Opens the options window.

2.12 Help Menu

- *OpenModelica Users Guide* - Opens the OpenModelica Users Guide.
- *OpenModelica Users Guide (PDF)* - Opens the OpenModelica Users Guide (PDF).
- *OpenModelica System Documentation* - Opens the OpenModelica System Documentation.
- *OpenModelica Scripting Documentation* - Opens the OpenModelica Scripting Documentation.
- *Modelica Documentation* - Opens the Modelica Documentation.
- *OMSimulator Users Guide* - Opens the OMSimulator Users Guide.
- *OpenModelica TLM Simulator Documentation* - Opens the OpenModelica TLM Simulator Documentation.
- *About OMEdit* - Shows the information about OpenModelica Connection Editor.

2.13 Modeling a Model

2.13.1 Creating a New Modelica Class

Creating a new Modelica class in OMEdit is rather straightforward. Choose any of the following methods,

- Select File > New Modelica Class from the menu.
- Click on New Modelica Class toolbar button.
- Click on the Create New Modelica Class button available at the left bottom of Welcome Perspective.
- Press Ctrl+N.

2.13.2 Opening a Modelica File

Choose any of the following methods to open a Modelica file,

- Select File > Open Model/Library File(s) from the menu.
- Click on Open Model/Library File(s) toolbar button.
- Click on the Open Model/Library File(s) button available at the right bottom of Welcome Perspective.
- Press Ctrl+O.

(Note, for editing Modelica system files like MSL (not recommended), see [Editing Modelica Standard Library](#))

2.13.3 Opening a Modelica File with Encoding

Select File > Open/Convert Modelica File(s) With Encoding from the menu. It is also possible to convert files to UTF-8.

2.13.4 Model Widget

For each Modelica class one Model Widget is created. It has a statusbar and a view area. The statusbar contains buttons for navigation between the views and labels for information. The view area is used to display the icon, diagram and text layers of Modelica class. See [Figure 2.9](#).

2.13.5 Adding Component Models

Drag the models from the Libraries Browser and drop them on either Diagram or Icon View of Model Widget.

2.13.6 Making Connections

In order to connect one component model to another the user first needs to enable the connect mode () from the toolbar.

Move the mouse over the connector. The mouse cursor will change from arrow cursor to cross cursor. To start the connection press left button and move while keeping the button pressed. Now release the left button. Move towards the end connector and click when cursor changes to cross cursor.

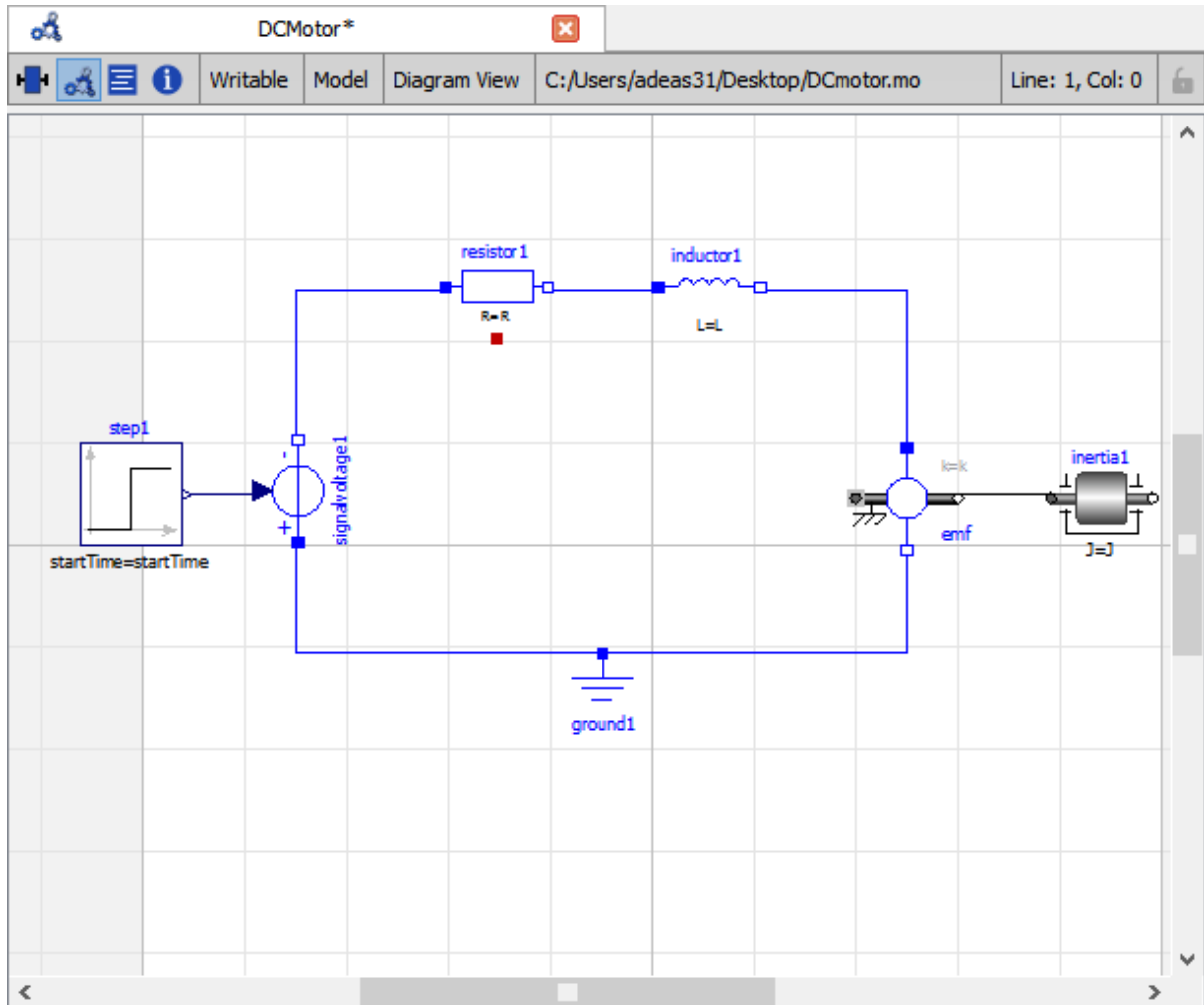

Figure 2.9: Model Widget showing the Diagram View.

2.14 Simulating a Model

The simulation process in OMEdit is split into three main phases:

1. The Modelica model is translated into C/C++ code. The model is first instantiated by the frontend, which turns it into a flat set of variables, parameters, equations, algorithms, and functions. The backend then analyzes the mathematical structure of the flat model, applies symbolic simplifications and determines how the equations can be solved efficiently. Finally, based on this information, model-specific C/C++ code is generated. This part of the process can be influenced by setting Translation Flags (a.k.a. *Command Line Options*), e.g. deciding which kind of structural simplifications should be performed during the translation phase.
2. The C/C++ code is compiled and linked into an executable simulation code. Additional *C/C++ compiler flags* can be given to influence this part of the process, e.g. by setting compiler optimizations such as `-O3`. Since multiple C/C++ source code files are generated for a given model, they are compiled in parallel by OMEdit, exploiting the power of multi-core CPUs.
3. The simulation executable is started and produces the simulation results in a *.mat* or *.csv* file. The runtime behaviour can be influenced by *Simulation Flags*, e.g. by choosing specific solvers, or changing the output file name. Note that it is possible to re-simulate a model multiple times, changing parameter values from the Variables Browser and/or changing some Simulation Flags. In this case, only Phase 3. is repeated, skipping Phases 1. and 2., which enables much faster iterations.

The simulation options for each model are stored inside the OMEdit data structure. They are set according to the following sequence,

- Each model has its own translation and simulation options.
- If the model is opened for the first time then the translation and simulation options are set to defaults, that can be customized in Tools | Options | Simulation.
- `experiment`, `__OpenModelica_commandLineOptions` and `__OpenModelica_simulationFlags` annotations are applied if the model contains them.
- After that all the changes done via Simulation Setup window for a certain model are preserved for the whole session. If you want to use the same settings in future sessions then you should store them inside `experiment`, `__OpenModelica_commandLineOptions`, and `__OpenModelica_simulationFlags` annotations.

The OMEdit Simulation Setup can be launched by,

- Selecting Simulation > Simulation Setup from the menu. (requires a model to be active in ModelWidget)
- Clicking on the Simulation Setup toolbar button. (requires a model to be active in ModelWidget)
- Right clicking the model from the Libraries Browser and choosing Simulation Setup.

2.14.1 General

- Simulation Interval
- *Start Time* – the simulation start time.
- *Stop Time* – the simulation stop time.
- *Number of Intervals* – the simulation number of intervals.
- *Interval* – the length of one interval (i.e., stepsize)
- Integration
 - *Method* – the simulation solver. See section *Integration Methods* for solver details.
 - *Tolerance* – the simulation tolerance.
 - *Jacobian* - the jacobian method to use.
 - DASSL/IDA Options
 - *Root Finding* - Activates the internal root finding procedure of dassl.

- *Restart After Event* - Activates the restart of dassl after an event is performed.
- *Initial Step Size*
- *Maximum Step Size*
- *Maximum Integration Order*
- *C/C++ Compiler Flags (Optional)* – the optional C/C++ compiler flags.
- *Number of Processors* – the number of processors used to build the simulation.
- *Build Only* – only builds the class.
- *Launch Transformational Debugger* – launches the transformational debugger.
- *Launch Algorithmic Debugger* – launches the algorithmic debugger.
- *Launch Animation* – launches the 3d animation window.

2.14.2 Interactive Simulation

- Simulate with steps (makes the interactive simulation synchronous; plots nicer curves at the expense of performance)
- Simulation server port

2.14.3 Translation Flags

2.14.4 Simulation Flags

- *Model Setup File (Optional)* – specifies a new setup XML file to the generated simulation code.
- *Initialization Method (Optional)* – specifies the initialization method.
- *Equation System Initialization File (Optional)* – specifies an external file for the initialization of the model.
- *Equation System Initialization Time (Optional)* – specifies a time for the initialization of the model.
- *Clock (Optional)* – the type of clock to use.
- *Linear Solver (Optional)* – specifies the linear solver method.
- *Non Linear Solver (Optional)* – specifies the nonlinear solver.
- *Linearization Time (Optional)* – specifies a time where the linearization of the model should be performed.
- *Output Variables (Optional)* – outputs the variables a, b and c at the end of the simulation to the standard output.
- *Profiling* – creates a profiling HTML file.
- *CPU Time* – dumps the cpu-time into the result file.
- *Enable All Warnings* – outputs all warnings.
- *Logging (Optional)*
- *stdout* - standard output stream. This stream is always active, can be disabled with `-lv=-stdout`
- *assert* - This stream is always active, can be disabled with `-lv=-assert`
- *LOG_DASSL* - additional information about dassl solver.
- *LOG_DASSL_STATES* - outputs the states at every dassl call.
- *LOG_DEBUG* - additional debug information.
- *LOG_DSS* - outputs information about dynamic state selection.
- *LOG_DSS_JAC* - outputs jacobian of the dynamic state selection.
- *LOG_DT* - additional information about dynamic tearing.
- *LOG_DT_CONS* - additional information about dynamic tearing (local and global constraints).

- *LOG_EVENTS* - additional information during event iteration.
- *LOG_EVENTS_V* - verbose logging of event system.
- *LOG_INIT* - additional information during initialization.
- *LOG_IPOPT* - information from Ipopt.
- *LOG_IPOPT_FULL* - more information from Ipopt.
- *LOG_IPOPT_JAC* - check jacobian matrix with Ipopt.
- *LOG_IPOPT_HESSE* - check hessian matrix with Ipopt.
- *LOG_IPOPT_ERROR* - print max error in the optimization.
- *LOG_JAC* - outputs the jacobian matrix used by dassl.
- *LOG_LS* - logging for linear systems.
- *LOG_LS_V* - verbose logging of linear systems.
- *LOG_NLS* - logging for nonlinear systems.
- *LOG_NLS_V* - verbose logging of nonlinear systems.
- *LOG_NLS_HOMOTOPY* - logging of homotopy solver for nonlinear systems.
- *LOG_NLS_JAC* - outputs the jacobian of nonlinear systems.
- *LOG_NLS_JAC_TEST* - tests the analytical jacobian of nonlinear systems.
- *LOG_NLS_RES* - outputs every evaluation of the residual function.
- *LOG_NLS_EXTRAPOLATE* - outputs debug information about extrapolate process.
- *LOG_RES_INIT* - outputs residuals of the initialization.
- *LOG_RT* - additional information regarding real-time processes.
- *LOG_SIMULATION* - additional information about simulation process.
- *LOG_SOLVER* - additional information about solver process.
- *LOG_SOLVER_V* - verbose information about the integration process.
- *LOG_SOLVER_CONTEXT* - context information during the solver process.
- *LOG_SOTI* - final solution of the initialization.
- *LOG_STATS* - additional statistics about timer/events/solver.
- *LOG_STATS_V* - additional statistics for LOG_STATS.
- *LOG_SUCCESS* - This stream is always active, can be disabled with `-lv=-LOG_SUCCESS`.
- *LOG_UTIL*.
- *LOG_ZEROCROSSINGS* - additional information about the zerocrossings.
- *Additional Simulation Flags (Optional)* – specify any other simulation flag.

2.14.5 Output

- *Output Format* – the simulation result file output format.
- *Single Precision* - Output results in single precision (only for mat output format).
- *File Name Prefix (Optional)* – the name is used as a prefix for the output files.
- *Result File (Optional)* - the simulation result file name.
- *Variable Filter (Optional)*
- *Protected Variables* – adds the protected variables in result file.
- *Equidistant Time Grid* – output the internal steps given by dassl instead of interpolating results into an equidistant time grid as given by stepSize or numberOfIntervals

- *Store Variables at Events* – adds the variables at time events.
- *Show Generated File* – displays the generated files in a dialog box.

2.14.6 Archived Simulations

Shows the list of simulations already finished or running. Double clicking on any of them opens the simulation output window.

2.15 2D Plotting

Successful simulation of model produces the result file which contains the instance variables that are candidate for plotting. Variables Browser will show the list of such instance variables. Each variable has a checkbox, checking it will plot the variable. See [Figure 2.7](#). To get several plot windows tiled horizontally or vertically use the menu items *Tile Windows Horizontally* or *Tile Windows Vertically* under *View Menu*.

2.15.1 Types of Plotting

The plotting type depends on the active Plot Window. By default the plotting type is Time Plot.

Time Plot

Plots the variable over the simulation time. You can have multiple Time Plot windows by clicking on New Plot Window toolbar button .

Plot Parametric

Draws a two-dimensional parametric diagram, between variables x and y , with y as a function of x . You can have multiple Plot Parametric windows by clicking on the New Plot Parametric toolbar button .

Array Plot

Plots an array variable so that the array elements' indexes are on the x-axis and corresponding elements' values are on the y-axis. The time is controlled by the slider above the variable tree. When an array is present in the model, it has a principal array node in the variable tree. To plot this array as an Array Plot, match the principal node. The principal node may be expanded into particular array elements. To plot a single element in the Time Plot, match the element. A new Array Plot window is opened using the New Array Plot Window toolbar button .

Array Parametric Plot

Plots the first array elements' values on the x-axis versus the second array elements' values on the y-axis. The time is controlled by the slider above the variable tree. To create a new Array Parametric Plot, press the New Array Parametric Plot Window toolbar button , then match the principle array node in the variable tree view to be plotted on the x-axis and match the principle array node to be plotted on the y-axis.

Diagram Window

Shows the active ModelWidget as a read only diagram. You can only have one Diagram Window. To show it click on Diagram Window toolbar button ()

2.16 Re-simulating a Model

The *Variables Browser* allows manipulation of changeable parameters for re-simulation. After changing the parameter values user can click on the re-simulate toolbar button () , or right click the model in Variables Browser and choose re-simulate from the menu.

2.17 3D Visualization

Since OpenModelica 1.11 , OMEdit has built-in 3D visualization, which replaces third-party libraries (such as Modelica3D) for 3D visualization.

2.17.1 Running a Visualization

The 3d visualization is based on OpenSceneGraph. In order to run the visualization simply right click the class in Libraries Browser and choose “**Simulate with Animation**” as shown in [Figure 2.10](#).



Figure 2.10: OMEdit Simulate with Animation.

One can also run the visualization via Simulation > Simulate with Animation from the menu.

When simulating a model in animation mode, the flag $+d=visxml$ is set. Hence, the compiler will generate a scene description file `_visual.xml` which stores all information on the multibody shapes. This scene description

references all variables which are needed for the animation of the multibody system. When simulating with `+d=visxml`, the compiler will always generate results for these variables.

2.17.2 Viewing a Visualization

After the successful simulation of the model, the visualization window will show up automatically as shown in Figure 2.11.

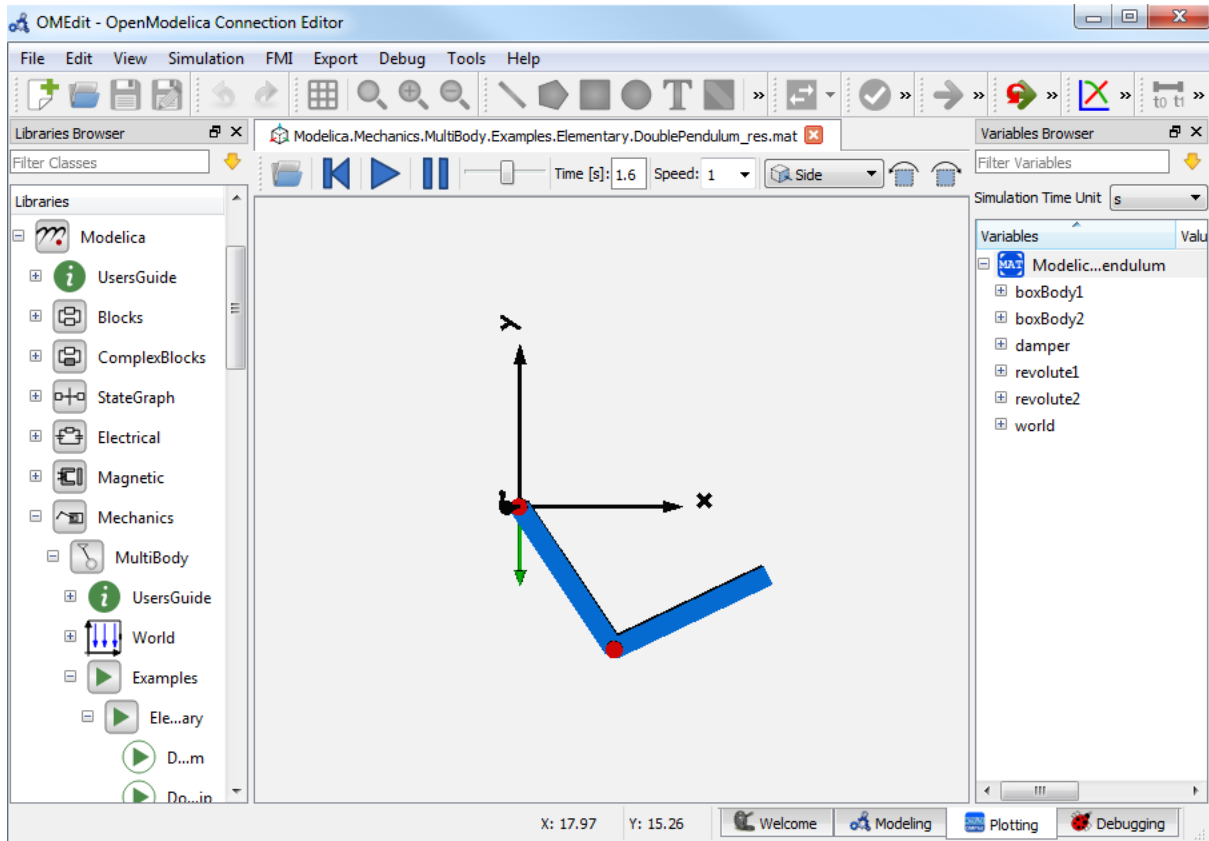

Figure 2.11: OMEdit 3D Visualization.

The animation starts with pushing the *play* button. The animation is played until *stopTime* or until the *pause* button is pushed. By pushing the *previous* button, the animation jumps to the initial point of time. Points of time can be selected by moving the *time slider* or by inserting a simulation time in the *Time-box*. The speed factor of animation in relation to realtime can be set in the *Speed-dialog*. Other animations can be opened by using the *open file* button and selecting a result file with a corresponding scene description file.

The 3D camera view can be manipulated as follows:

Operation	Key	Mouse Action
Move Closer/Further	none	Wheel
Move Closer/Further	Right Mouse Hold	Up/Down
Move Up/Down/Left/Right	Middle Mouse Hold	Move Mouse
Move Up/Down/Left/Right	Left and Right Mouse Hold	Move Mouse
Rotate	Left Mouse Hold	Move Mouse
Shape context menu	Right Mouse + Shift	

Predefined views (Isometric, Side, Front, Top) can be selected and the scene can be tilted by 90° either clock or anticlockwise with the rotation buttons.

2.17.3 Additional Visualization Features

The shapes that are displayed in the viewer can be selected with shift + right click. If a shape is selected, a context menu pops up that offers additional visualization features

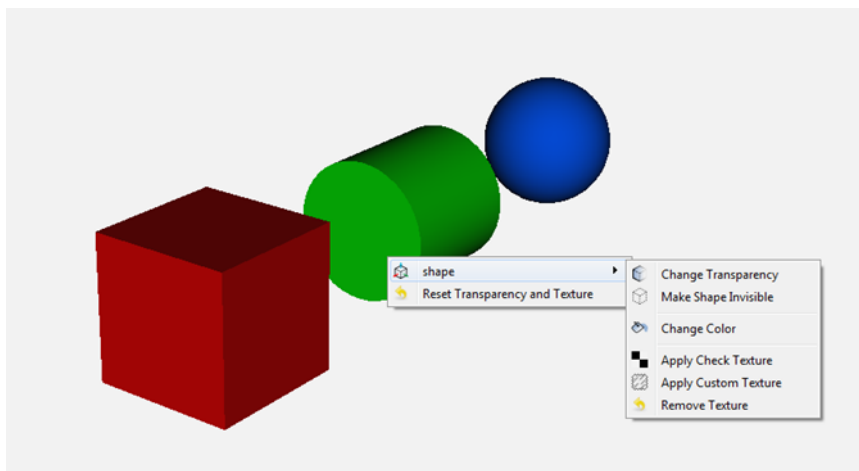

The following features can be selected:

Menu	Description
Change Transparency	The shape becomes either transparent or intransparent.
Make Shape Invisible	The shape becomes invisible.
Change Color	A color dialog pops up and the color of the shape can be set.
Apply Check Texture	A checked texture is applied to the shape.
Apply Custom Texture	A file selection dialog pops up and an image file can be selected as a texture.
Remove Texture	Removes the current texture of the shape.

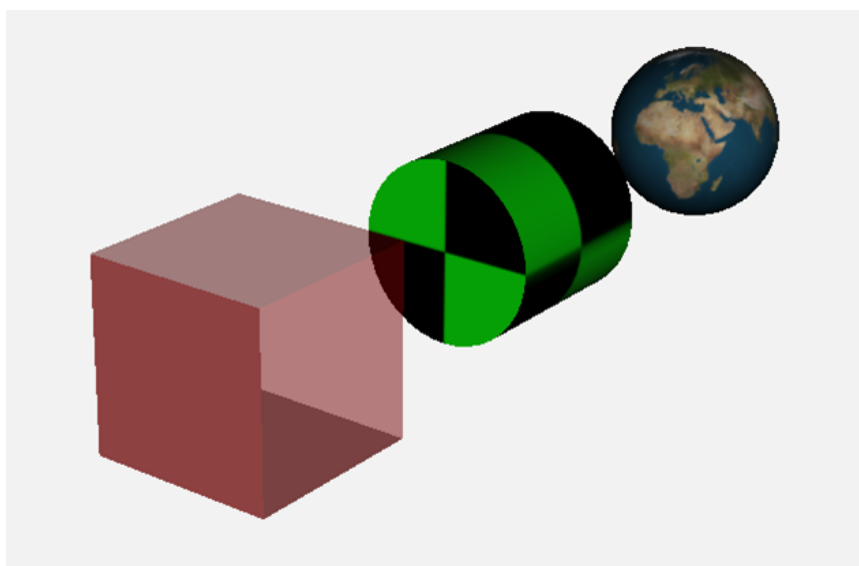

2.18 Animation of Realtime FMUs

Instead of a result file, OMEdit can load Functional Mock-up Units to retrieve the data for the animation of multibody systems. Just like opening a mat-file from the animation-plotting view, one can open an FMU-file. Necessarily, the FMU has to be generated with the `+d=visxml` flag activated, so that a scene description file is generated in the same directory as the FMU. Currently, only FMU 1.0 and FMU 2.0 model exchange are supported. When choosing an FMU, the simulation settings window pops up to choose solver and step size. Afterwards, the model initializes and can be simulated by pressing the play button.

2.18.1 Interactive Realtime Animation of FMUs

FMUs can be simulated with realtime user interaction. A possible solution is to equip the model with an interaction model from the Modelica_DeviceDrivers library (https://github.com/modelica/Modelica_DeviceDrivers). The realtime synchronization is done by OMEdit so no additional time synchronization model is necessary.

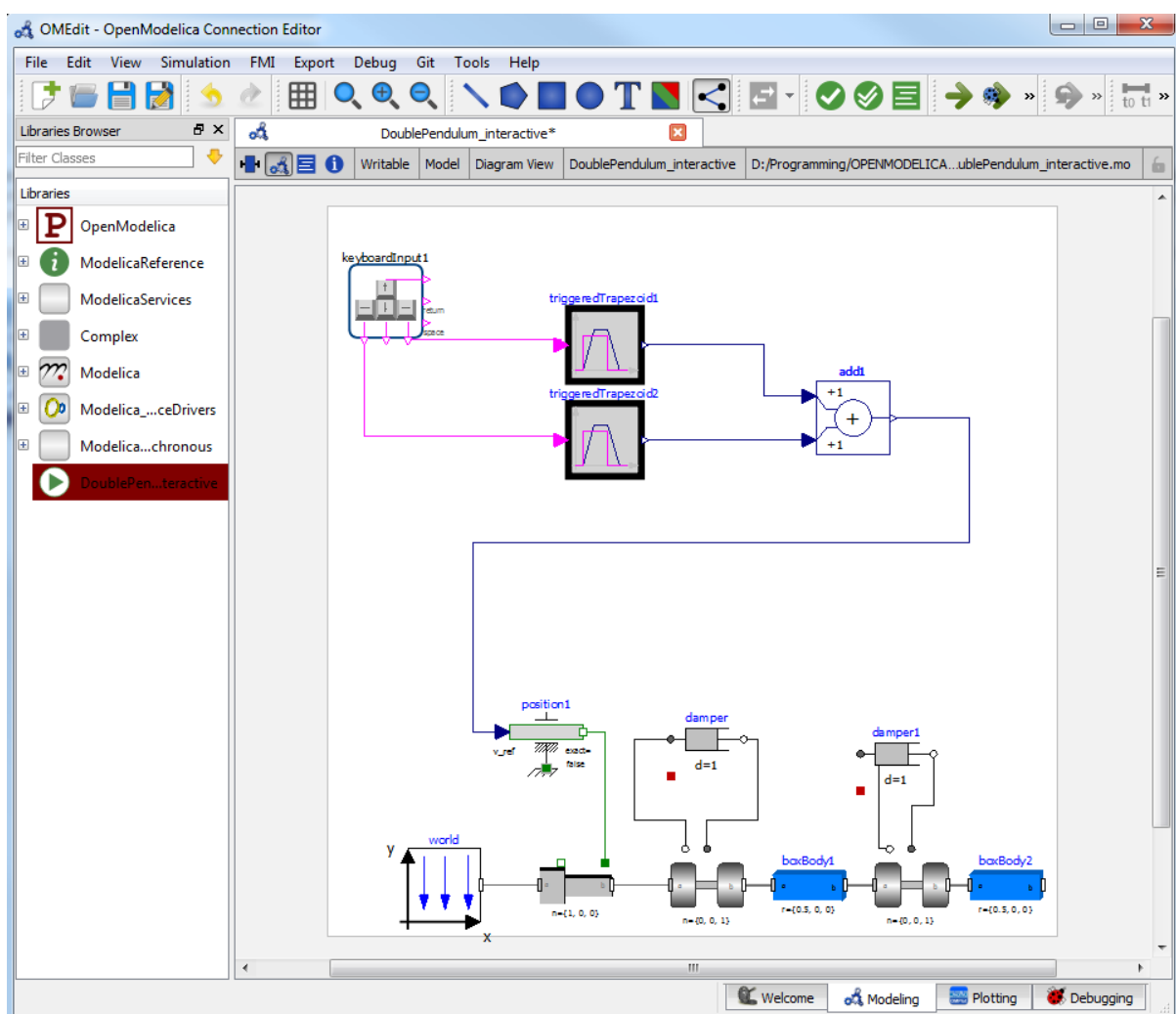

2.19 Interactive Simulation

Warning: Interactive simulation is an experimental feature.

Interactive simulation is enabled by selecting interactive simulation in the simulation setup.

There are two main modes of execution: asynchronous and synchronous (simulate with steps). The difference is that in synchronous (step mode), OMEdit sends a command to the simulation for each step that the simulation should take. The asynchronous mode simply tells the simulation to run and samples variables values in real-time; if the simulation runs very fast, fewer values will be sampled.

When running in asynchronous mode, it is possible to simulate the model in real-time (with a scaling factor just like simulation flag `-rt`, but with the ability to change the scaling factor during the interactive simulation). In the synchronous mode, the speed of the simulation does not directly correspond to real-time.

2.20 How to Create User Defined Shapes – Icons

Users can create shapes of their own by using the shape creation tools available in OMEdit.

- *Line Tool* – Draws a line. A line is created with a minimum of two points. In order to create a line, the user first selects the line tool from the toolbar and then click on the Icon/Diagram View; this will start creating a line. If a user clicks again on the Icon/Diagram View a new line point is created. In order to finish the line creation, user has to double click on the Icon/Diagram View.
- *Polygon Tool* – Draws a polygon. A polygon is created in a similar fashion as a line is created. The only difference between a line and a polygon is that, if a polygon contains two points it will look like a line and if a polygon contains more than two points it will become a closed polygon shape.
- *Rectangle Tool* – Draws a rectangle. The rectangle only contains two points where first point indicates the starting point and the second point indicates the ending the point. In order to create rectangle, the user has to select the rectangle tool from the toolbar and then click on the Icon/Diagram View, this click will become the first point of rectangle. In order to finish the rectangle creation, the user has to click again on the Icon/Diagram View where he/she wants to finish the rectangle. The second click will become the second point of rectangle.
- *Ellipse Tool* – Draws an ellipse. The ellipse is created in a similar way as a rectangle is created.
- *Text Tool* – Draws a text label.
- *Bitmap Tool* – Draws a bitmap container.

The shape tools are located in the toolbar. See [Figure 2.12](#).

The user can select any of the shape tools and start drawing on the Icon/Diagram View. The shapes created on the Diagram View of Model Widget are part of the diagram and the shapes created on the Icon View will become the icon representation of the model.

For example, if a user creates a model with name `testModel` and add a rectangle using the rectangle tool and a polygon using the polygon tool, in the Icon View of the model. The model's Modelica Text will appear as follows:

```
model testModel
  annotation (Icon(graphics = {Rectangle(rotation = 0, lineColor = {0,0,255},
↪fillColor = {0,0,255}, pattern = LinePattern.Solid, fillPattern = FillPattern.
↪None, lineThickness = 0.25, extent = {{ -64.5,88},{63, -22.5}}),Polygon(points =
↪{{ -47.5, -29.5},{52.5, -29.5},{4.5, -86},{ -47.5, -29.5}}, rotation = 0,
↪lineColor = {0,0,255}, fillColor = {0,0,255}, pattern = LinePattern.Solid,
↪fillPattern = FillPattern.None, lineThickness = 0.25)}));
end testModel;
```

In the above code snippet of `testModel`, the rectangle and a polygon are added to the icon annotation of the model. Similarly, any user defined shape drawn on a Diagram View of the model will be added to the diagram annotation of the model.

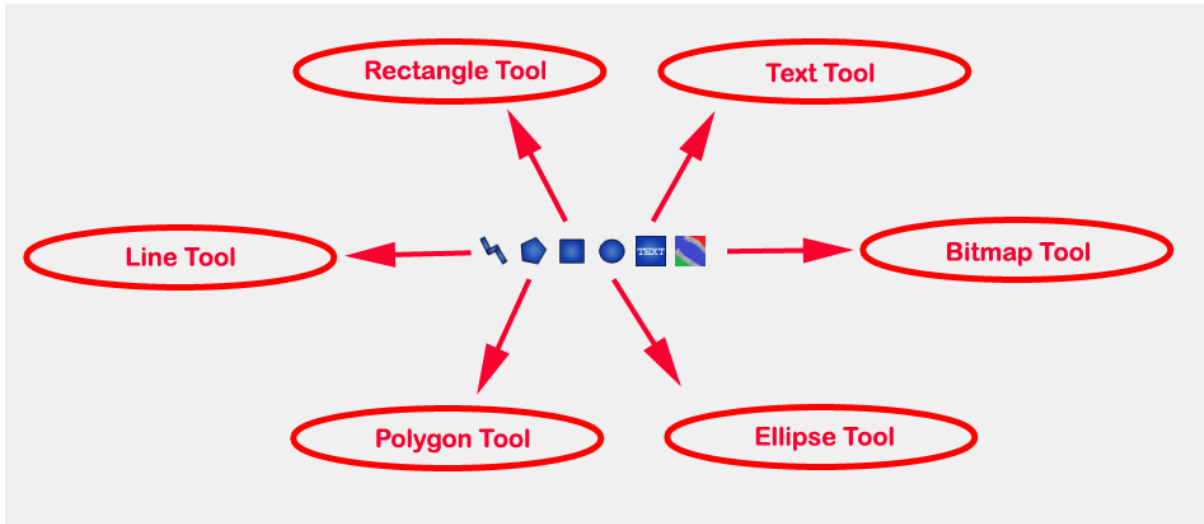

Figure 2.12: User defined shapes.

2.21 Global head section in documentation

If you want to use same styles or same JavaScript for the classes contained inside a package then you can define `__OpenModelica_infoHeader` annotation inside the `Documentation` annotation of a package. For example,

```
package P
  model M
    annotation(Documentation(info="<html>
      <a href=\"javascript:HelloWorld()\">Click here</a>
    </html>"));
  end M;
  annotation(Documentation(__OpenModelica_infoHeader="
    <script type=\"text/javascript\">
      function HelloWorld() {
        alert(\"Hello World!\");
      }
    </script>"));
end P;
```

In the above example model `M` does not need to define the javascript function `HelloWorld`. It is only defined once at the package level using the `__OpenModelica_infoHeader` and then all classes contained in the package can use it.

In addition styles and JavaScript can be added from file locations using Modelica URIs. Example:

```
package P
  model M
    annotation(Documentation(info="<html>
      <a href=\"javascript:HelloWorld()\">Click here</a>
    </html>"));
  end M;
  annotation(Documentation(__OpenModelica_infoHeader="
    <script type=\"text/javascript\">
      src=\"modelica://P/Resources/hello.js\"
    </script>"));
end P;
```

Where the file `Resources/hello.js` then contains:

```
function HelloWorld() {  
  alert("Hello World!");  
}
```

2.22 Options

OMEdit allows users to save several options which will be remembered across different sessions of OMEdit. The Options Dialog can be used for reading and writing the options.

2.22.1 General

- General
- *Language* – Sets the application language.
- *Working Directory* – Sets the application working directory. All files are generated in this directory.
- *Toolbar Icon Size* – Sets the size for toolbar icons.
- *Preserve User's GUI Customizations* – If true then OMEdit will remember its windows and toolbars positions and sizes.
- *Terminal Command* – Sets the terminal command. When user clicks on Tools > Open Terminal then this command is executed.
- *Terminal Command Arguments* – Sets the terminal command arguments.
- *Hide Variables Browser* – Hides the variable browser when switching away from plotting perspective.
- *Activate Access Annotations* – Activates the access annotations for the non-encrypted libraries. Access annotations are always active for encrypted libraries.
- *Create a model.bak-mo backup file when deleting a model*
- Libraries Browser
- *Library Icon Size* – Sets the size for library icons.
- *Max. Library Icon Text Length to Show* – Sets the maximum text length that can be shown in the icon in Libraries Browser.
- *Show Protected Classes* – If enabled then Libraries Browser will also list the protected classes.
- *Show Hidden Classes* – If enabled then Libraries Browser will also list the hidden classes. Ignores the annotation(Protection(access = Access.hide))
- *Enable Auto Save* - Enables/disables the auto save feature.
- *Auto Save interval* – Sets the auto save interval value. The minimum possible interval value is 60 seconds.
- Welcome Page
- *Horizontal View/Vertical View* – Sets the view mode for welcome page.
- *Show Latest News* - If enabled then the latest news from <https://openmodelica.org> are shown.
- Optional Features
- *Enable replaceable support* - Enables/disables the replaceable support.

2.22.2 Libraries

- *System Libraries* – The list of system libraries that should be loaded every time OMEdit starts.
- *Force loading of Modelica Standard Library* – If true then Modelica and ModelicaReference will always load even if user has removed them from the list of system libraries.
- *Load OpenModelica library on startup* – If true then OpenModelica package will be loaded when OMEdit is started.
- *User Libraries* – The list of user libraries/files that should be loaded every time OMEdit starts.

2.22.3 Text Editor

- Format
- *Line Ending* - Sets the file line ending.
- *Byte Order Mark (BOM)* - Sets the file BOM.
- Tabs and Indentation
- *Tab Policy* – Sets the tab policy to either spaces or tabs only.
- *Tab Size* – Sets the tab size.
- *Indent Size* – Sets the indent size.
- Syntax Highlight and Text Wrapping
 - *Enable Syntax Highlighting* – Enable/Disable the syntax highlighting.
 - *Enable Code Folding* - Enable/Disable the code folding. When code folding is enabled multi-line annotations are collapsed into a compact icon (a rectangle containing "..."). A marker containing a "+" sign becomes available at the left-side of the involved line, allowing the code to be expanded/re-collapsed at will.
 - *Match Parentheses within Comments and Quotes* – Enable/Disable the matching of parentheses within comments and quotes.
 - *Enable Line Wrapping* – Enable/Disable the line wrapping.
- Autocomplete
- *Enable Autocomplete* – Enables/Disables the autocomplete.
- Font
- *Font Family* – Shows the names list of available fonts. Sets the font for the editor.
- *Font Size* – Sets the font size for the editor.

2.22.4 Modelica Editor

- *Preserve Text Indentation* – If true then uses *diffModelicaFileListings* API call otherwise uses the OMC pretty-printing.
- Colors
- *Items* – List of categories used of syntax highlighting the code.
- *Item Color* – Sets the color for the selected item.
- *Preview* – Shows the demo of the syntax highlighting.

2.22.5 MetaModelica Editor

- Colors
- *Items* – List of categories used of syntax highlighting the code.
- *Item Color* – Sets the color for the selected item.
- *Preview* – Shows the demo of the syntax highlighting.

2.22.6 CompositeModel Editor

- Colors
- *Items* – List of categories used of syntax highlighting the code.
- *Item Color* – Sets the color for the selected item.
- *Preview* – Shows the demo of the syntax highlighting.

2.22.7 SSP Editor

- Colors
- *Items* – List of categories used of syntax highlighting the code.
- *Item Color* – Sets the color for the selected item.
- *Preview* – Shows the demo of the syntax highlighting.

2.22.8 C/C++ Editor

- Colors
- *Items* – List of categories used of syntax highlighting the code.
- *Item Color* – Sets the color for the selected item.
- *Preview* – Shows the demo of the syntax highlighting.

2.22.9 HTML Editor

- Colors
- *Items* – List of categories used of syntax highlighting the code.
- *Item Color* – Sets the color for the selected item.
- *Preview* – Shows the demo of the syntax highlighting.

2.22.10 Graphical Views

- General
 - Modeling View Mode
 - *Tabbed View/SubWindow View* – Sets the view mode for modeling.
 - Default View
 - *Icon View/DiagramView/Modelica Text View/Documentation View* – If no preferredView annotation is defined then this setting is used to show the respective view when user double clicks on the class in the Libraries Browser.
 - *Move connectors together on both icon and diagram layers*
- Graphics

- Icon/Diagram View
 - * Extent
 - * *Left* – Defines the left extent point for the view.
 - * *Bottom* – Defines the bottom extent point for the view.
 - * *Right* – Defines the right extent point for the view.
 - * *Top* – Defines the top extent point for the view.
 - * Grid
 - * *Horizontal* – Defines the horizontal size of the view grid.
 - * *Vertical* – Defines the vertical size of the view grid.
 - * Component
 - * *Scale factor* – Defines the initial scale factor for the component dragged on the view.
 - * *Preserve aspect ratio* – If true then the component's aspect ratio is preserved while scaling.

2.22.11 Simulation

- Simulation
 - *Matching Algorithm* – sets the matching algorithm for simulation.
 - *Index Reduction Method* – sets the index reduction method for simulation.
 - *Show additional information from the initialization process* - prints the information from the initialization process
 - *Evaluate all parameters (faster simulation, cannot change them at runtime)* - makes the simulation more efficient but you have to recompile the model if you want to change the parameter instead of re-simulate.
 - *Enable analytical jacobian for non-linear strong components* - enables analytical jacobian for non-linear strong components without user-defined function calls.
 - *Enable pedantic debug-mode, to get much more feedback*
 - *Enable parallelization of independent systems of equations (Experimental)*
 - *Enable old frontend for code generation*
 - *Enable data reconciliation*
 - *Additional Translation Flags* – sets the translation flags see [Options](#)
 - *Target Language* – sets the target language in which the code is generated.
 - *Target Build* – sets the target build that is used to compile the generated code.
 - *C Compiler* – sets the C compiler for compiling the generated code.
 - *CXX Compiler* – sets the CXX compiler for compiling the generated code.
 - *Ignore __OpenModelica_commandLineOptions annotation* – if true then ignores the __OpenModelica_commandLineOptions annotation while running the simulation.
 - *Ignore __OpenModelica_simulationFlags annotation* – if true then ignores the __OpenModelica_simulationFlags annotation while running the simulation.
 - *Enable new frontend use in OMC API (faster GUI response)* - if true then uses the new frontend in OMC API calls.
 - *Display errors/warnings when instantiating the graphical annotations* - if true then the errors/warnings are shown when using OMC API for graphical annotations.
 - *Save class before simulation* – if true then always saves the class before running the simulation.

- *Switch to plotting perspective after simulation* – if true then GUI always switches to plotting perspective after the simulation.
- *Close completed simulation output windows before simulation* – if true then the completed simulation output windows are closed before starting a new simulation.
- *Delete intermediate compilation files* – if true then the files generated during the compilation are deleted automatically.
- *Delete entire simulation directory of the model when OMEdit is closed* – if true then the entire simulation directory is deleted on quit.
- **Output**
- *Structured* - Shows the simulation output in the form of tree structure.
- *Formatted Text* - Shows the simulation output in the form of formatted text.
- *Display Limit* - Sets the display limit for simulation output. A link to log file is shown once the limit is reached.

2.22.12 Messages

- **General**
- *Output Size* - Specifies the maximum number of rows the Messages Browser may have. If there are more rows then the rows are removed from the beginning.
- *Reset messages number before simulation* – Resets the messages counter before starting the simulation.
- *Clear messages browser before checking, instantiation & simulation* – If enabled then the messages browser is cleared before checking, instantiation & simulation of model.
- **Font and Colors**
- *Font Family* – Sets the font for the messages.
- *Font Size* – Sets the font size for the messages.
- *Notification Color* – Sets the text color for notification messages.
- *Warning Color* – Sets the text color for warning messages.
- *Error Color* – Sets the text color for error messages.

2.22.13 Notifications

- **Notifications**
- *Always quit without prompt* – If true then OMEdit will quit without prompting the user.
- *Show item dropped on itself message* – If true then a message will pop-up when a class is dragged and dropped on itself.
- *Show model is partial and component is added as replaceable message* – If true then a message will pop-up when a partial class is added to another class.
- *Show component is declared as inner message* – If true then a message will pop-up when an inner component is added to another class.
- *Show save model for bitmap insertion message* – If true then a message will pop-up when user tries to insert a bitmap from a local directory to an unsaved class.
- *Always ask for the dragged component name* – If true then a message will pop-up when user drag & drop the component on the graphical view.
- *Always ask for what to do with the text editor error* – If true then a message will always pop-up when there is an error in the text editor.
- If new frontend for code generation fails

- *Always ask for old frontend*
- *Try with old frontend once*
- *Switch to old frontend permanently*
- *Keep using new frontend*

2.22.14 Line Style

- Line Style
- *Color* – Sets the line color.
- *Pattern* – Sets the line pattern.
- *Thickness* – Sets the line thickness.
- *Start Arrow* – Sets the line start arrow.
- *End Arrow* – Sets the line end arrow.
- *Arrow Size* – Sets the start and end arrow size.
- *Smooth* – If true then the line is drawn as a Bezier curve.

2.22.15 Fill Style

- Fill Style
- *Color* – Sets the fill color.
- *Pattern* – Sets the fill pattern.

2.22.16 Plotting

- General
- *Auto Scale* – sets whether to auto scale the plots or not.
- Plotting View Mode
- *Tabbed View/SubWindow View* – Sets the view mode for plotting.
- Curve Style
- *Pattern* – Sets the curve pattern.
- *Thickness* – Sets the curve thickness.
- Variable filter
- *Filter Interval* - Delay in filtering the variables. Set the value to 0 if you don't want any delay.
- Font Size - sets the font size for plot window items
- *Title*
- *Vertical Axis Title*
- *Vertical Axis Numbers*
- *Horizontal Axis Title*
- *Horizontal Axis Numbers*
- *Footer*
- *Legend*

2.22.17 Figaro

- Figaro
- *Figaro Library* – the Figaro library file path.
- *Tree generation options* – the Figaro tree generation options file path.
- *Figaro Processor* – the Figaro processor location.

2.22.18 Debugger

- Algorithmic Debugger
- *GDB Path* – the gnu debugger path
- *GDB Command Timeout* – timeout for gdb commands.
- *GDB Output Limit* – limits the GDB output to N characters.
- *Display C frames* – if true then shows the C stack frames.
- *Display unknown frames* – if true then shows the unknown stack frames. Unknown stack frames means frames whose file path is unknown.
- *Clear old output on a new run* – if true then clears the output window on new run.
- *Clear old log on new run* – if true then clears the log window on new run.
- Transformational Debugger
- *Always show Transformational Debugger after compilation* – if true then always open the Transformational Debugger window after model compilation.
- *Generate operations in the info xml* – if true then adds the operations information in the info xml file.

2.22.19 FMI

- Export
 - Version
 - *1.0* – Sets the FMI export version to 1.0
 - *2.0* – Sets the FMI export version to 2.0
 - Type
 - *Model Exchange* – Sets the FMI export type to Model Exchange.
 - *Co-Simulation* – Sets the FMI export type to Co-Simulation.
 - *Model Exchange and Co-Simulation* – Sets the FMI export type to Model Exchange and Co-Simulation.
 - *FMU Name* – Sets a prefix for generated FMU file.
 - *Move FMU* – Moves the generated FMU to a specified path.
 - *Platforms* - list of platforms to generate FMU binaries.
 - *Model Description Filters* - Sets the variable filter for model description file.
 - *Include Source Code* - Sets if the exported FMU can contain source code. Model Description Filter "blackBox" will override this, because black box FMUs do never contain their source code.
- Import
 - *Delete FMU directory and generated model when OMEdit is closed* - If true then the temporary FMU directory that is created for importing the FMU will be deleted.

2.22.20 OMTLMSimulator

- General
- *Path* - path to OMTLMSimulator bin directory.
- *Manager Process* - path to OMTLMSimulator managar process.
- *Monitor Process* - path to OMTLMSimulator monitor process.

2.22.21 OMSimulator/SSP

- General
- *Command Line Options* - sets the OMSimulator command line options.
- *Logging Level* - OMSimulator logging level.

2.23 __OpenModelica_commandLineOptions Annotation

OpenModelica specific annotation to define the command line options needed to simulate the model. For example if you always want to simulate the model with a specific matching algorithm and index reduction method instead of the default ones then you can write the following code,

```
model Test
  annotation(__OpenModelica_commandLineOptions = "--matchingAlgorithm=BFSB --
↪indexReductionMethod=dynamicStateSelection");
end Test;
```

The annotation is a space separated list of options where each option is either just a command line flag or a flag with a value.

In OMEdit open the Simulation Setup and set the Translation Flags then in the bottom check *Save translation flags inside model* i.e., *__OpenModelica_commandLineOptions* annotation and click on OK.

If you want to ignore this annotation then use *setCommandLineOptions("--ignoreCommandLineOptionsAnnotation=true")*. In OMEdit *Tools > Options > Simulation* check *Ignore __OpenModelica_commandLineOptions* annotation.

2.24 __OpenModelica_simulationFlags Annotation

OpenModelica specific annotation to define the simulation options needed to simulate the model. For example if you always want to simulate the model with a specific solver instead of the default DASSL and would also like to see the cpu time then you can write the following code,

```
model Test
  annotation(__OpenModelica_simulationFlags(s = "heun", cpu = "()));
end Test;
```

The annotation is a comma separated list of options where each option is a simulation flag with a value. For flags that doesn't have any value use *()* (See the above code example).

In OMEdit open the Simulation Setup and set the Simulation Flags then in the bottom check *Save simulation flags inside model* i.e., *__OpenModelica_simulationFlags* annotation and click on OK.

If you want to ignore this annotation then use *setCommandLineOptions("--ignoreSimulationFlagsAnnotation=true")*. In OMEdit *Tools > Options > Simulation* check *Ignore __OpenModelica_simulationFlags* annotation.

2.25 Debugger

For debugging capability, see *Debugging*.

2.26 Editing Modelica Standard Library

By default OMEdit loads the Modelica Standard Library (MSL) as a system library. System libraries are read-only. If you want to edit MSL you need to load it as user library instead of system library. We don't recommend editing MSL but if you really need to and understand the consequences then follow these steps,

- Go to *Tools > Options > Libraries*.
- Remove Modelica & ModelicaReference from list of system libraries.
- Uncheck *force loading of Modelica Standard Library*.
- Add `$OPENMODELICAHOME/lib/omlibrary/Modelica X.X/package.mo` under user libraries.
- Restart OMEdit.

2.27 State Machines

2.27.1 Creating a New Modelica State Class

Follow the same steps as defined in *Creating a New Modelica Class*. Additionally make sure you check the *State* checkbox.



Figure 2.13: Creating a new Modelica state.

2.27.2 Making Transitions

In order to make a transition from one state to another the user first needs to enable the transition mode (☰) from the toolbar.

Move the mouse over the state. The mouse cursor will change from arrow cursor to cross cursor. To start the transition press left button and move while keeping the button pressed. Now release the left button. Move towards the end state and click when cursor changes to cross cursor.

A *Create Transition* dialog box will appear which allows you to set the transition attributes. Cancelling the dialog will cancel the transition.

Double click the transition or right click and choose *Edit Transition* to modify the transition attributes.

2.27.3 State Machines Simulation

Support for Modelica state machines was added in the Modelica Language Specification v3.3. A subtle problem can occur if Modelica v3.2 libraries are loaded, e.g., the Modelica Standard Library v3.2.2, because in this case OMC automatically switches into Modelica v3.2 compatibility mode. Trying to simulate a state machine in Modelica v3.2 compatibility mode results in an error. It is possible to use the OMC flag `--std=latest` in order to ensure (at least) Modelica v3.3 support. In OMEdit this can be achieved by setting that flag in the *Tools > Options > Simulation* dialog.

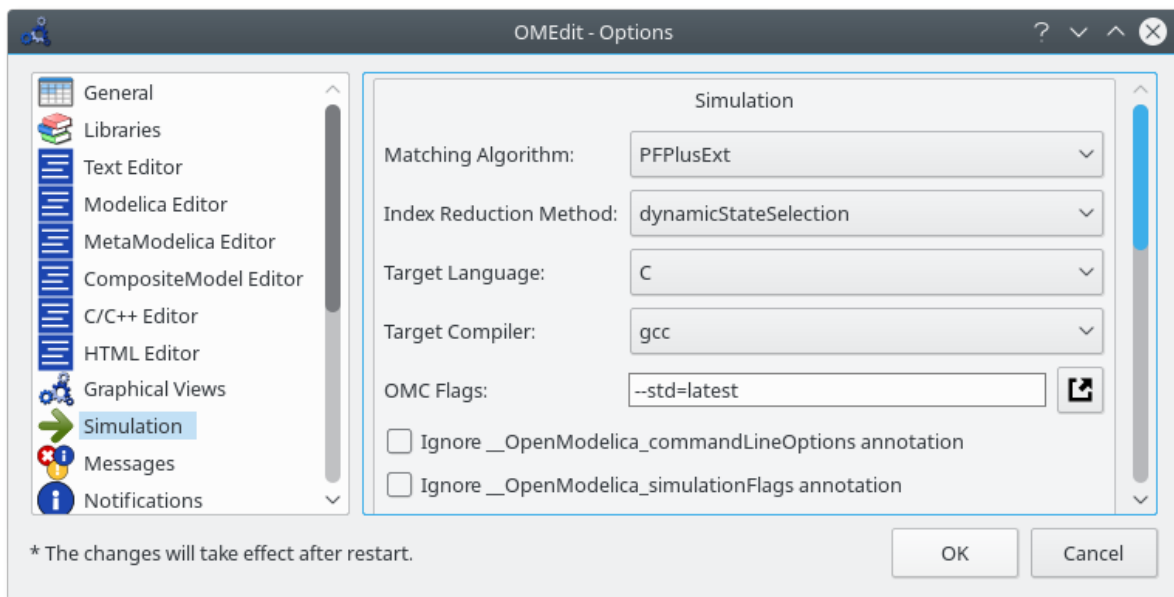

Figure 2.14: Ensure (at least) Modelica v3.3 support.

2.27.4 State Machines Debugger

Modelica state machines debugger is implemented as a visualization, which allows the user to run the state machines simulation as an animation.

A special Diagram Window is developed to visualize the active and inactive states. The active and inactive value of the states are stored in the OpenModelica simulation result file. After the successful simulation, of the state machine model, OMEdit reads the start, stop time values, and initializes the visualization controls accordingly.

The controls allows the easy manipulation of the visualization,

- Rewind – resets the visualization to start.
- Play – starts the visualization.



Figure 2.15: State machine debugger in OMEdit.

- Pause – pauses the visualization.
- Time – allows the user to jump at any specific time.
- Speed – speed of the visualization.
- Slider – controls the time.

The visualization is based on the simulation result file. All three formats of the simulation result file are supported i.e., mat, csv and plt where mat is a matlab file format, csv is a comma separated file and plt is an ordered text file.

It is only possible to debug one state machine at a time. This is achieved by marking the result file active in the Variables Browser. The visualization only read the values from the active result file. It is possible to simulate several state machine models. In that case, the user will see a list of result files in the Variables Browser. The user can switch between different result files by right clicking on the result file and selecting *Set Active* in the context menu.

2.28 Using OMEdit as Text Editor

OMEdit can be used as a Text editor. Currently support for editing MetaModelica, Modelica and C/C++ are available with syntax highlighting and autocompletion of keywords and types. Additionally the Modelica and MetaModelica files are provided with autocompletion of code-snippets along with keywords and types. The users can load the directory from file menu *File > Open Directory*. which opens the Directory structure in the Libraries-browser.

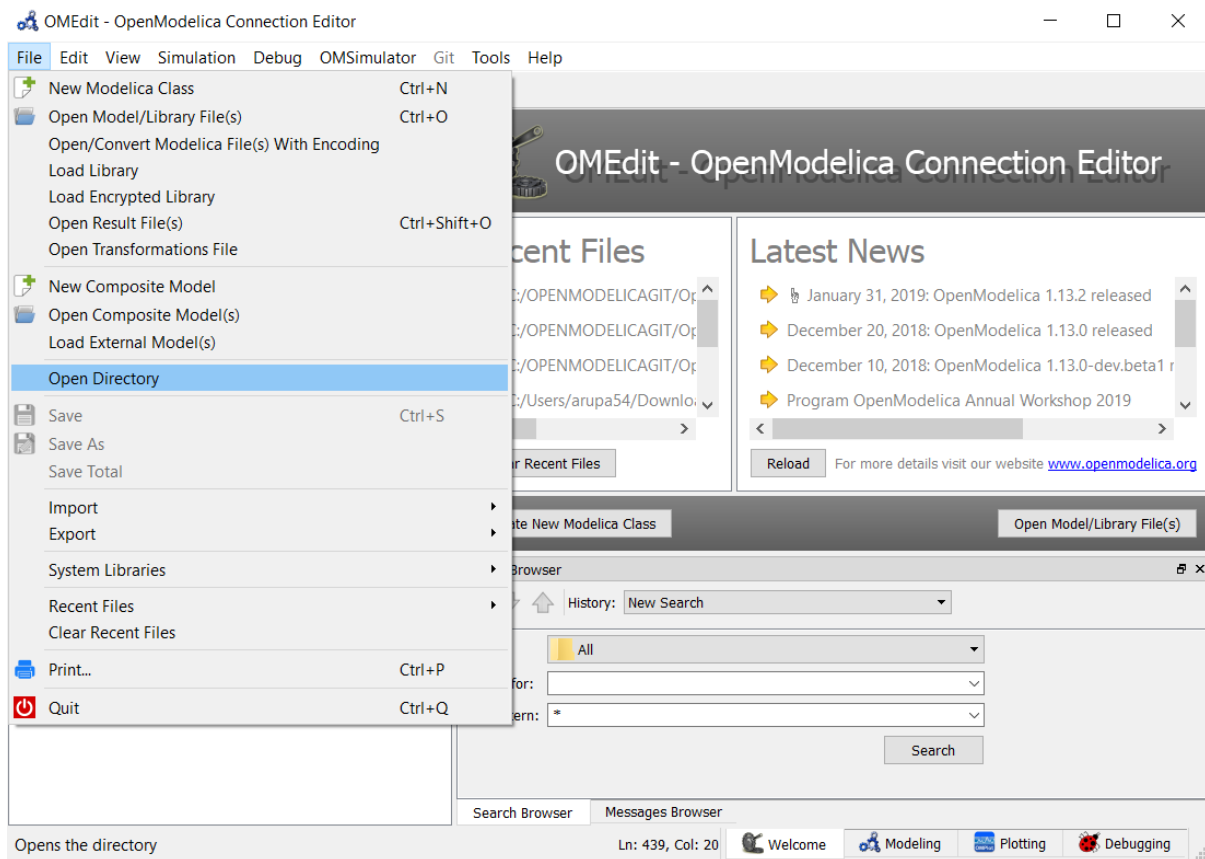

Figure 2.16: open-directory

After the directory is opened in the Libraries-browser, the users can expand the directory structure and click the file which opens in the texteditor.



Figure 2.17: openfile in texteditor

2.28.1 Advanced Search

Support to search in OMEdit texteditor is available. The search browser can be enabled by selecting View > Windows > Search browser or through shortcut keys (ctrl+h).

The users can start the search by loading the directory they want to search and fill in the text to be searched for and file pattern if needed and click the search button.

After the search is completed the results are presented to the users in a separate window, The search results contains the following

- 1) The name of the files where the searched word is matched
- 2) The line number and text of the matched word.

The users can click the line number or the matched text and it will automatically open the file in the texteditor and move the cursor to matched line number of the text.

The users can perform multiple searches and go back to old search results using search history option.



Figure 2.18: Enable omedit search browser

2.29 Temporary Directory, Log Files and Working Directory

On Unix/Linux systems temporary directory is the path in the *TMPDIR* environment variable or */tmp* if *TMPDIR* is not defined appended with directory paths *OpenModelica<USERNAME>/OMEdit* so the complete path is usually */tmp/OpenModelica<USERNAME>/OMEdit*.

On Windows its the path in the *TEMP* or *TMP* environment variable appended with directory paths *OpenModelica/OMEdit* so the complete path is usually *%TEMP%/OpenModelica/OMEdit*.

All the log files are always generated in the temporary directory. Choose *Tools > Open Temporary Directory* to open the temporary directory.

By default the working directory has the same path as the temporary directory. You can change the working directory from *Tools > Options > General* see section *General*.

For each simulation a new directory with the model name is created in the working directory and then all the simulation intermediate and results files are generated in it.

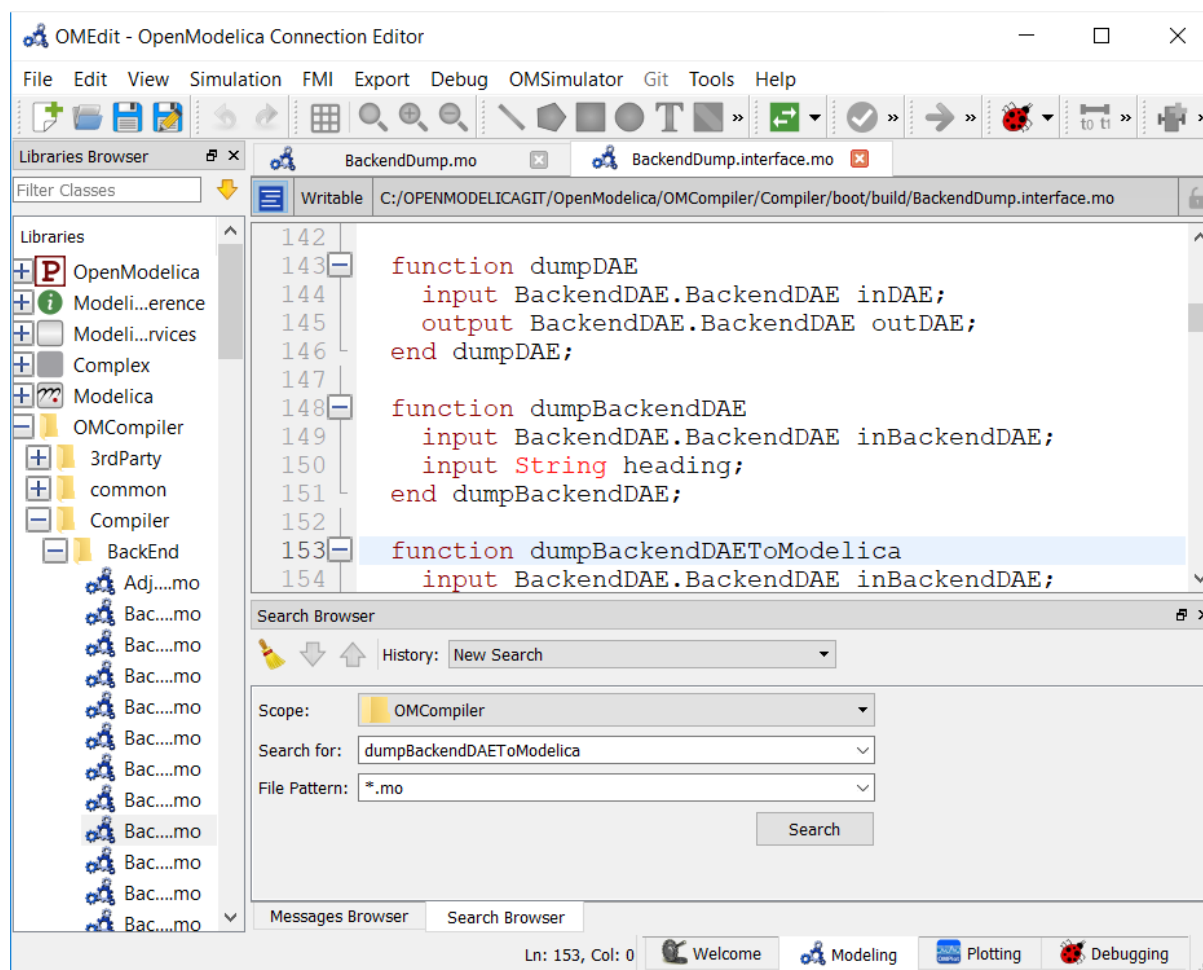

Figure 2.19: Start search in search browser

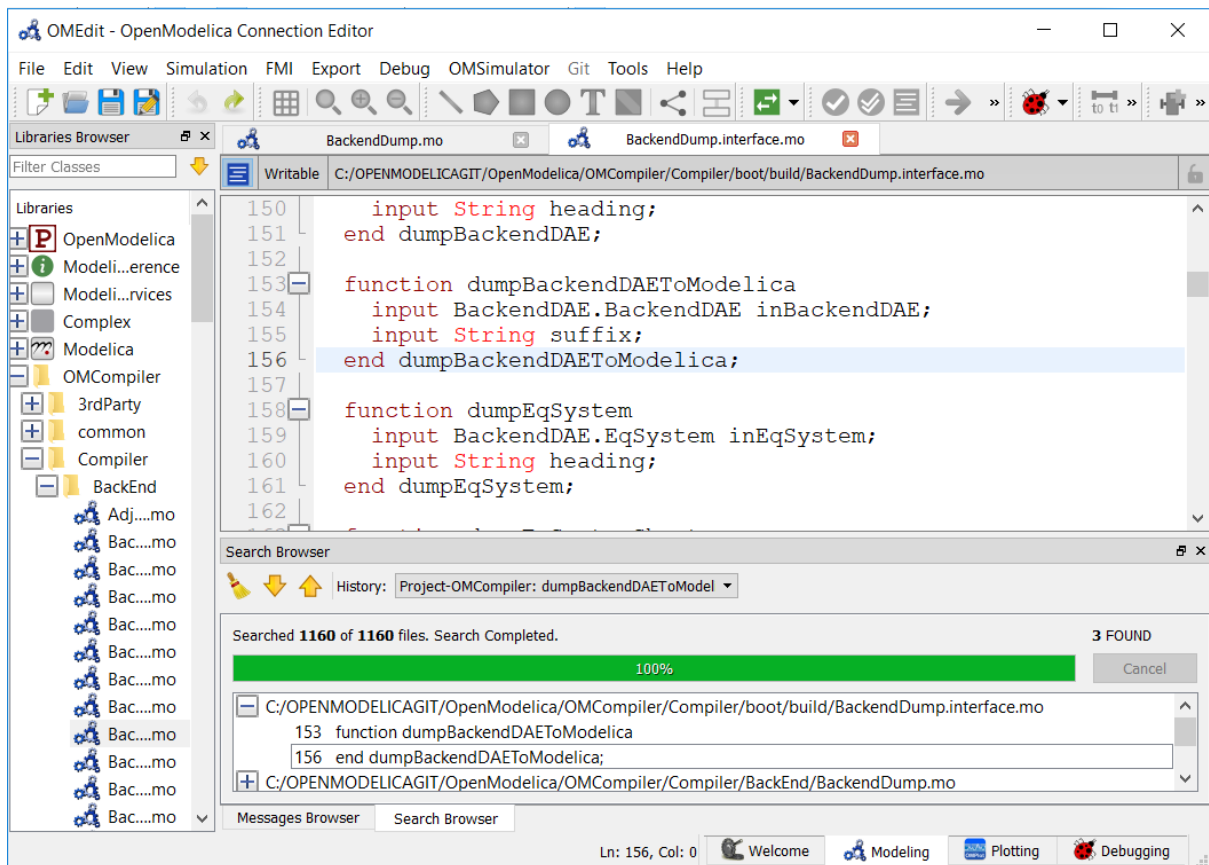

Figure 2.20: Search Results



Figure 2.21: Search History

2D PLOTTING

This chapter covers the 2D plotting available in OpenModelica via OMNotebook, OMShell and command line script. The plotting is based on OMPlot application. See also OMEdit *2D Plotting*.

3.1 Example

```
class HelloWorld
  Real x(start = 1, fixed = true);
  parameter Real a = 1;
equation
  der(x) = - a * x;
end HelloWorld;
```

To create a simple time plot the above model HelloWorld is simulated. To reduce the amount of simulation data in this example the number of intervals is limited with the argument numberOfIntervals=5. The simulation is started with the command below.

```
>>> simulate(HelloWorld, outputFormat="csv", startTime=0, stopTime=4,
↳numberOfIntervals=5)
record SimulationResult
  resultFile = "«DOCHOME»/HelloWorld_res.csv",
  simulationOptions = "startTime = 0.0, stopTime = 4.0, numberOfIntervals = 5,
↳tolerance = 1e-06, method = 'dassl', fileNamePrefix = 'HelloWorld', options = '',
↳ outputFormat = 'csv', variableFilter = '.*', cflags = '', simflags = '',
  messages = "LOG_SUCCESS      | info      | The initialization finished.
↳successfully without homotopy method.
LOG_SUCCESS      | info      | The simulation finished successfully.
",
  timeFrontend = 0.004636604,
  timeBackend = 0.00939247,
  timeSimCode = 0.00057616200000000001,
  timeTemplates = 0.003820691,
  timeCompile = 0.422244336,
  timeSimulation = 0.015153424,
  timeTotal = 0.455943561
end SimulationResult;
```

When the simulation is finished the file *HelloWorld_res.csv* contains the simulation data:

Listing 3.1: HelloWorld_res.csv

```
"time", "x", "der(x)"
0, 1, -1
0.8, 0.4493289092712475, -0.4493289092712475
1.6, 0.2018973974273906, -0.2018973974273906
2.4, 0.09071896372718975, -0.09071896372718975
3.2, 0.04076293845066793, -0.04076293845066793
```

(continues on next page)

(continued from previous page)

```
4, 0.01831609502171534, -0.01831609502171534
4, 0.01831609502171534, -0.01831609502171534
```

Diagrams are now created with the new OMPlot program by using the following plot command:

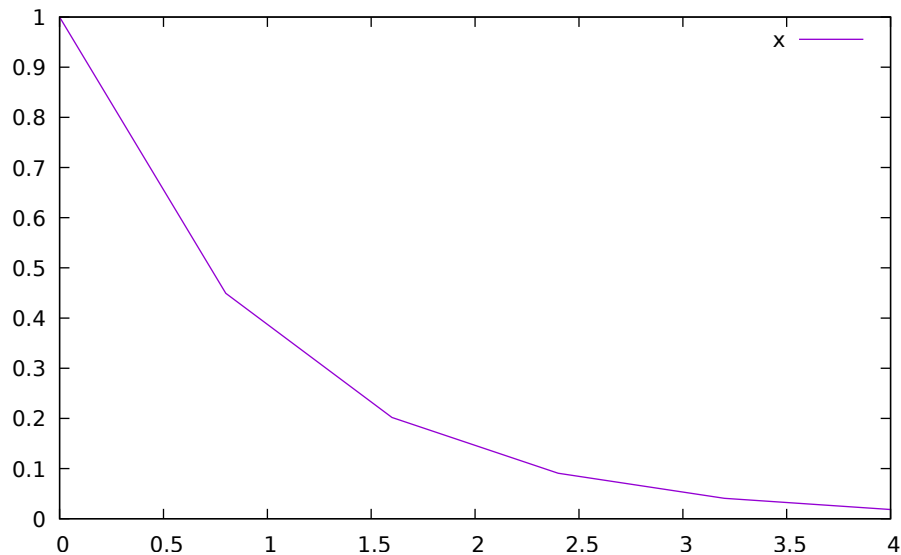

Figure 3.1: Simple 2D plot of the HelloWorld example.

By re-simulating and saving results at many more points, for example using the default 500 intervals, a much smoother plot can be obtained. Note that the default solver method dassl has more internal points than the output points in the initial plot. The results are identical, except the detailed plot has a smoother curve.

```
>>> 0==system("./HelloWorld -override stepSize=0.008")
true
>>> res:=strtok(readFile("HelloWorld_res.csv"), "\n");
>>> res[end]
"4, 0.01831609502171534, -0.01831609502171534"
```



Figure 3.2: Simple 2D plot of the HelloWorld example with a larger number of output points.

3.2 Plot Command Interface

Plot command have a number of optional arguments to further customize the the resulting diagram.

```
>>> list (OpenModelica.Scripting.plot, interfaceOnly=true)
"function plot
  input VariableNames vars \"The variables you want to plot\";
  input Boolean externalWindow = false \"Opens the plot in a new plot window\";
  input String fileName = \"<default>\" \"The filename containing the variables.
↪<default> will read the last simulation result\";
  input String title = \"\" \"This text will be used as the diagram title.\";
  input String grid = \"detailed\" \"Sets the grid for the plot i.e simple,
↪detailed, none.\";
  input Boolean logX = false \"Determines whether or not the horizontal axis is
↪logarithmically scaled.\";
  input Boolean logY = false \"Determines whether or not the vertical axis is
↪logarithmically scaled.\";
  input String xLabel = \"time\" \"This text will be used as the horizontal label
↪in the diagram.\";
  input String yLabel = \"\" \"This text will be used as the vertical label in the
↪diagram.\";
  input Real xRange[2] = {0.0, 0.0} \"Determines the horizontal interval that is
↪visible in the diagram. {0,0} will select a suitable range.\";
  input Real yRange[2] = {0.0, 0.0} \"Determines the vertical interval that is
↪visible in the diagram. {0,0} will select a suitable range.\";
  input Real curveWidth = 1.0 \"Sets the width of the curve.\";
  input Integer curveStyle = 1 \"Sets the style of the curve. SolidLine=1,
↪DashLine=2, DotLine=3, DashDotLine=4, DashDotDotLine=5, Sticks=6, Steps=7.\";
  input String legendPosition = \"top\" \"Sets the POSITION of the legend i.e left,
↪right, top, bottom, none.\";
  input String footer = \"\" \"This text will be used as the diagram footer.\";
  input Boolean autoScale = true \"Use auto scale while plotting.\";
  input Boolean forceOMPlot = false \"if true launches OMPlot and doesn't call
↪callback function even if it is defined.\";
  output Boolean success \"Returns true on success\";
end plot;\"
```

SOLVING MODELICA MODELS

4.1 Integration Methods

By default OpenModelica transforms a Modelica model into an ODE representation to perform a simulation by using numerical integration methods. This section contains additional information about the different integration methods in OpenModelica. They can be selected by the method parameter of the *simulate* command or the *-s simflag*.

The different methods are also called solver and can be distinguished by their characteristic:

- explicit vs. implicit
- order
- step size control
- multi step

A good introduction on this topic may be found in [CK06] and a more mathematical approach can be found in [HNorsettW93].

4.1.1 DASSL

DASSL is the default solver in OpenModelica, because of a several reasons. It is an implicit, higher order, multi-step solver with a step-size control and with these properties it is quite stable for a wide range of models. Furthermore it has a mature source code, which was originally developed in the eighties an initial description may be found in [Pet82].

This solver is based on backward differentiation formula (BDF), which is a family of implicit methods for numerical integration. The used implementation is called DASPK2.0 (see²) and it is translated automatically to C by f2c (see³).

The following simulation flags can be used to adjust the behavior of the solver for specific simulation problems: *jacobian*, *noRootFinding*, *noRestart*, *initialStepSize*, *maxStepSize*, *maxIntegrationOrder*, *noEquidistantTimeGrid*.

4.1.2 IDA

The IDA solver is part of a software family called sundials: SUite of Nonlinear and Differential/ALgebraic equation Solvers [HBG+05]. The implementation is based on DASPK with an extended linear solver interface, which includes an interface to the high performance sparse linear solver KLU [DN10].

The simulation flags of *DASSL* are also valid for the IDA solver and furthermore it has the following IDA specific flags: *idaLS*, *idaMaxNonLinIters*, *idaMaxConvFails*, *idaNonLinConvCoef*, *idaMaxErrorTestFails*.

² DASPK Webpage

³ Cdaskr source

4.1.3 CVODE

The CVODE solver is part of sundials: SUite of Nonlinear and Differential/ALgebraic equation Solvers [HBG+05]. CVODE solves initial value problems for ordinary differential equation (ODE) systems with variable-order, variable-step multistep methods.

In OpenModelica, CVODE uses a combination of Backward Differentiation Formulas (varying order 1 to 5) as linear multi-step method and a modified Newton iteration with fixed Jacobian as non-linear solver per default. This setting is advised for stiff problems which are very common for Modelica models. For non-stiff problems an combination of an Adams-Moulton formula (varying order 1 to 12) as linear multi-step method together with a fixed-point iteration as non-linear solver method can be chosen.

Both non-linear solver methods are internal functions of CVODE and use its internal direct dense linear solver CVDense. For the Jacobian of the ODE CVODE will use its internal dense difference quotient approximation.

CVODE has the following solver specific flags: *cvodeNonlinearSolverIteration*, *cvodeLinearMultistepMethod*.

4.1.4 Basic Explicit Solvers

The basic explicit solvers are performing with a fixed step-size and differ only in the integration order. The step-size is based on the numberOfIntervals, the startTime and stopTime parameters in the *simulate* command:

$$\text{stepSize} \approx \frac{\text{stopTime} - \text{startTime}}{\text{numberOfIntervals}}$$

- euler - order 1
- heun - order 2
- rungekutta - order 4

4.1.5 Basic Implicit Solvers

The basic implicit solvers are all based on the non-linear solver KINSOL from the SUNDIALS suite. The underlying linear solver can be modified with the simflag *-impRKLS*. The step-size is determined as for the basic explicit solvers.

- impeuler - order 1
- trapezoid - order 2
- imprungekutta - Based on Radau IIA and Lobatto IIIA defined by its Butcher tableau where the order can be adjusted by *-impRKorder*.

4.1.6 Experimental Solvers

The following solvers are marked as experimental, mostly because they are till now not tested very well.

- cvode - experimental implementation of SUNDIALS CVODE solver - BDF or Adams-Moulton method - step size control, order 1-12
- rungekuttaSsc - Runge-Kutta based on Novikov (2016) - explicit, step-size control, order 4-5
- irksco - Own developed Runge-Kutta solver - implicit, step-size control, order 1-2
- symSolver - Symbolic inline solver (requires *--symSolver*) - fixed step-size, order 1
- symSolverSsc - Symbolic implicit inline Euler with step-size control (requires *--symSolver*) - step-size control, order 1-2
- qss - A QSS solver

4.2 DAE Mode Simulation

Beside the default ODE simulation, OpenModelica is able to simulate models in *DAE mode*. The *DAE mode* is enabled by the flag `--daeMode`. In general the whole equation system of a model is passed to the DAE integrator, including all algebraic loops. This reduces the amount of work that needs to be done in the post optimization phase of the OpenModelica backend. Thus models with large algebraic loops might compile faster in *DAE mode*.

Once a model is compiled in *DAE mode* the simulation can be only performed with *SUNDIALS/IDA* integrator and with enabled `-daeMode` simulation flag. Both are enabled automatically by default, when a simulation run is started.

4.3 Initialization

To simulate an ODE representation of an Modelica model with one of the methods shown in *Integration Methods* a valid initial state is needed. Equations from an initial equation or initial algorithm block define a desired initial system.

4.3.1 Choosing start values

Only non-linear iteration variables in non-linear strong components require start values. All other start values will have no influence on convergence of the initial system.

Use `-d=initialization` to show additional information from the initialization process. In OMEdit Tools->Options->Simulation->OMCFlags, in OMNotebook call `setCommandLineOptions("-d=initialization")`

model piston

```
Modelica.Mechanics.MultiBody.Parts.Fixed fixed1 annotation( Placement(visible = true, transformation(origin = {-80, 70}, extent = {{-10, -10}, {10, 10}}, rotation = 0)));
```

```
Modelica.Mechanics.MultiBody.Parts.Body body1(m = 1) annotation( Placement(visible = true, transformation(origin = {30, 70}, extent = {{-10, -10}, {10, 10}}, rotation = 0)));
```

```
Modelica.Mechanics.MultiBody.Parts.FixedTranslation fixedTranslation1(r = {0.3, 0, 0}) annotation( Placement(visible = true, transformation(origin = {-10, 70}, extent = {{-10, -10}, {10, 10}}, rotation = 0)));
```

```
Modelica.Mechanics.MultiBody.Parts.FixedTranslation fixedTranslation2(r = {0.8, 0, 0}) annotation( Placement(visible = true, transformation(origin = {10, 20}, extent = {{-10, -10}, {10, 10}}, rotation = -90)));
```

```
Modelica.Mechanics.MultiBody.Parts.Fixed fixed2(animation = false, r = {1.1, 0, 0}) annotation( Placement(visible = true, transformation(origin = {70, -60}, extent = {{-10, -10}, {10, 10}}, rotation = 180)));
```

```
Modelica.Mechanics.MultiBody.Parts.Body body2(m = 1) annotation( Placement(visible = true, transformation(origin = {30, -30}, extent = {{-10, -10}, {10, 10}}, rotation = 0)));
```

```
inner Modelica.Mechanics.MultiBody.World world annotation( Placement(visible = true, transformation(origin = {-70, -50}, extent = {{-10, -10}, {10, 10}}, rotation = 0)));
```

```
Modelica.Mechanics.MultiBody.Joints.Prismatic prismatic(animation = true) annotation( Placement(visible = true, transformation(origin = {30, -60}, extent = {{-10, -10}, {10, 10}}, rotation = 0)));
```

```
Modelica.Mechanics.MultiBody.Joints.RevolutePlanarLoopConstraint revolutePlanar annotation( Placement(visible = true, transformation(origin = {-50, 70}, extent = {{-10, -10}, {10, 10}}, rotation = 0)));
```

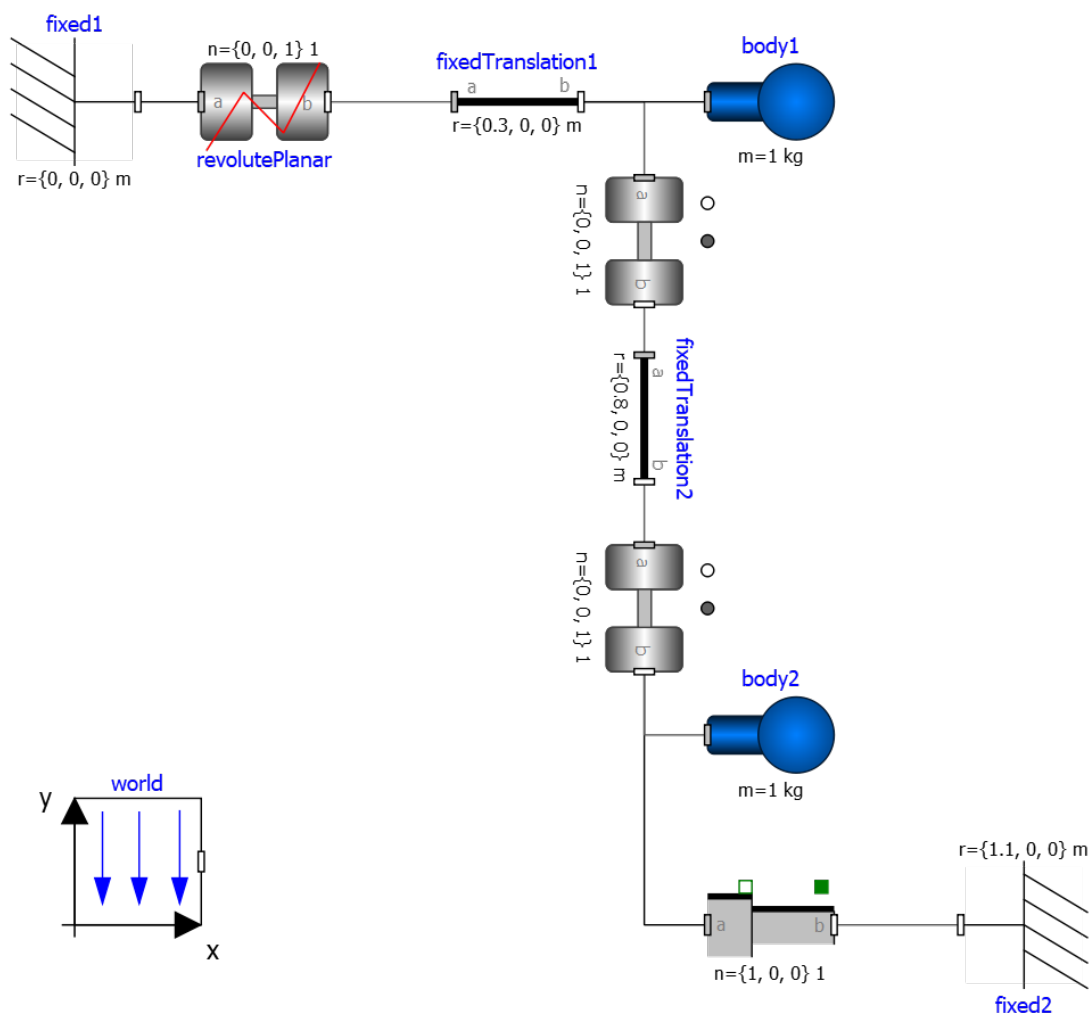

Figure 4.1: piston.mo

Modelica.Mechanics.MultiBody.Joints.Revolute revolute1(a(fixed = false),phi(fixed = false), w(fixed = false)) annotation Placement(visible = true, transformation(origin = {10, 48}, extent = {{-10, -10}, {10, 10}}, rotation = -90));

Modelica.Mechanics.MultiBody.Joints.Revolute revolute2 annotation Placement(visible = true, transformation(origin = {10, -10}, extent = {{-10, -10}, {10, 10}}, rotation = -90));

equation

connect(prismatic.frame_b, fixed2.frame_b) annotation Line(points = {{40, -60}, {60, -60}, {60, -60}, {60, -60}}, color = {95, 95, 95});

connect(fixed1.frame_b, revolutePlanar.frame_a) annotation Line(points = {{-70, 70}, {-60, 70}, {-60, 70}, {-60, 70}}, color = {95, 95, 95});

connect(revolutePlanar.frame_b, fixedTranslation1.frame_a) annotation Line(points = {{-40, 70}, {-20, 70}, {-20, 70}, {-20, 70}}, color = {95, 95, 95});

connect(fixedTranslation1.frame_b, revolute1.frame_a) annotation Line(points = {{0, 70}, {10, 70}, {10, 58}, {10, 58}}, color = {95, 95, 95});

connect(revolute1.frame_b, fixedTranslation2.frame_a) annotation Line(points = {{10, 38}, {10, 38}, {10, 30}, {10, 30}}, color = {95, 95, 95});

connect(revolute2.frame_b, prismatic.frame_a) annotation Line(points = {{10, -20}, {10, -20}, {10, -20}, {20, -60}, {20, -60}}, color = {95, 95, 95});

connect(revolute2.frame_b, body2.frame_a) annotation Line(points = {{10, -20}, {10, -20}, {10, -30}, {20, -30}, {20, -30}}, color = {95, 95, 95});

connect(revolute2.frame_a, fixedTranslation2.frame_b) annotation Line(points = {{10, 0}, {10, 0}, {10, 10}, {10, 10}}, color = {95, 95, 95});

connect(fixedTranslation1.frame_b, body1.frame_a) annotation Line(points = {{0, 70}, {18, 70}, {18, 70}, {20, 70}}, color = {95, 95, 95});

end piston;

```
>>> setCommandLineOptions("-d=initialization");
>>> buildModel(piston);
"Error: Failed to load package piston (default) using MODELICAPATH_
↳«OPENMODELICAHOME»/lib/omlibrary.
Error: Class piston not found in scope <TOP>.
"
```

Note how OpenModelica will inform the user about relevant and irrelevant start values for this model and for which variables a fixed default start value is assumed. The model has four joints but only one degree of freedom, so one of the joints *revolutePlanar* or *prismatic* must be initialized.

So, initializing *phi* and *w* of *revolutePlanar* will give a sensible start system.

```
model pistonInitialize
  extends piston(revolute1.phi.fixed = true, revolute1.phi.start = -1.
↳221730476396031, revolute1.w.fixed = true, revolute1.w.start = 5);
equation
end pistonInitialize;
```

```
>>> setCommandLineOptions("-d=initialization");
>>> simulate(pistonInitialize, stopTime=2.0);
"[<interactive>:2:3-2:136:writable] Error: Base class piston not found in scope_
↳pistonInitialize.
Error: Error occurred while flattening model pistonInitialize
"
```

Error: Unable to execute gnuplot directive

```
Traceback (most recent call last): File "/var/lib/jenkins2/ws/OpenModelica_maintenance_v1.16/doc/UsersGuide/source/sphinxcon
line 200, in run assert(omc.sendExpression('filterSimulationResults("%s", "%s", %s)' % (file-
name, csvfile, varstrquoted))) AssertionError
```

4.3.2 Homotopy Method

For complex start conditions OpenModelica can have trouble finding a solution for the initialization problem with the default newton method.

Modelica offers the homotopy operator⁴ to formulate actual and simplified expression for equations. OpenModelica has different solvers available for non-linear systems. Initializing with homotopy on the first try is default if a homotopy operator is used. It can be switched off with *noHomotopyOnFirstTry*. For more details on the homotopy method see [openmodelica.org:doc-extra:ochel2013initialization].

Several compiler and simulation flags influence initialization with homotopy: *--homotopyApproach*, *-homAdaptBend*, *-homBacktraceStrategy*, *-homHEps*, *-homMaxLambdaSteps*, *-homMaxNewtonSteps*, *-homMaxTries*, *-homNegStartDir*, *-homotopyOnFirstTry*, *-homTauDecFac*, *-homTauDecFacPredictor*, *-homTauIncFac*, *-homTauIncThreshold*, *-homTauMax*, *-homTauMin*, *-homTauStart*, *-ils*.

4.3.3 References

⁴ Modelica Association, Modelica® - A Unified Object-Oriented Language for Systems Modeling Language Specification - Version 3.4, 2017

DEBUGGING

There are two main ways to debug Modelica code, the *transformations browser*, which shows the transformations OpenModelica performs on the equations. There is also a debugger for *debugging of algorithm sections and functions*.

5.1 The Equation-based Debugger

This section gives a short description how to get started using the equation-based debugger in OMEdit.

5.1.1 Enable Tracing Symbolic Transformations

This enables tracing symbolic transformations of equations. It is optional but strongly recommended in order to fully use the debugger. The compilation time overhead from having this tracing on is less than 1%, however, in addition to that, some time is needed for the system to write the xml file containing the transformation tracing information.

Enable `-d=infoXmlOperations` in Tools->Options->Simulation (see section *Simulation*) OR alternatively click on the checkbox *Generate operations in the info xml* in Tools->Options->Debugger (see section *Debugger*) which performs the same thing.

This adds all the transformations performed by OpenModelica on the equations and variables stored in the `model_info.xml` file. This is necessary for the debugger to be able to show the whole path from the source equation(s) to the position of the bug.

5.1.2 Load a Model to Debug

Load an interesting model. We will use the package `Debugging.mo` since it contains suitable, broken models to demonstrate common errors.

5.1.3 Simulate and Start the Debugger

Select and simulate the model as usual. For example, if using the Debugging package, select the model `Debugging.Chattering.ChatteringEvents1`. If there is an error, you will get a clickable link that starts the debugger. If the user interface is unresponsive or the running simulation uses too much processing power, click cancel simulation first.

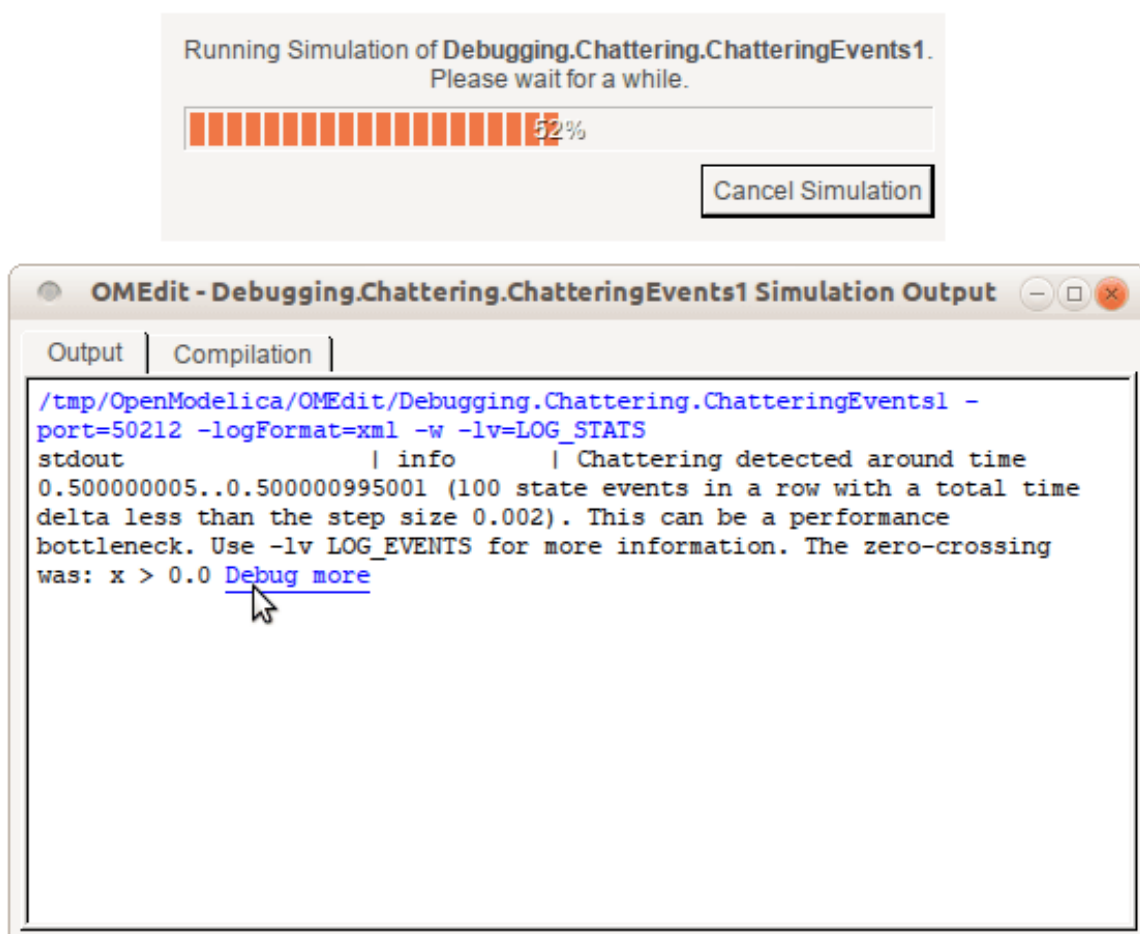

Figure 5.1: Simulating the model.

5.1.4 Use the Transformation Debugger for Browsing

The debugger opens on the equation where the error was found. You can browse through the dependencies (variables that are defined by the equation, or the equation is dependent on), and similar for variables. The equations and variables form a bipartite graph that you can walk.

If the `-d=infoXmlOperations` was used or you clicked the “generate operations” button, the operations performed on the equations and variables can be viewed. In the example package, there are not a lot of operations because the models are small.

Try some larger models, e.g. in the MultiBody library or some other library, to see more operations with several transformation steps between different versions of the relevant equation(s). If you do not trigger any errors in a model, you can still open the debugger, using File->Open Transformations File (model_info.json).

The screenshot displays the OMEdit - Transformational Debugger interface. The main window title is "OMEdit - Transformational Debugger" and the file path is "/tmp/OpenModelica_marsj/OMEdit/Debugging.Chattering.ChatteringEvents1_info.xml".

The interface is divided into several panes:

- Variables Browser:** Shows a list of variables (x, y, z) with their line numbers and locations. Below this, there are sections for "Defined In Equations" and "Used In Equations".
- Equations Browser:** Shows a list of equations (1-7) with their types and equations. Equation 5 is highlighted in orange.
- Source Browser:** Shows the Modelica code for the package "Chattering". It includes declarations for variables x, y, z and equations for their derivatives. Equation 5 is highlighted in blue.
- Variable Operations:** Shows the variable "z" and its definition.
- Equation Operations:** Shows the original and flattened equations for equation 5.

Figure 5.2: Transformations Browser.

5.2 The Algorithmic Debugger

This section gives a short description how to get started using the algorithmic debugger in OMEdit. See section *Simulation* for further details of debugger options.

5.2.1 Adding Breakpoints

There are two ways to add the breakpoints,

- Click directly on the line number in Text View, a red circle is created indicating a breakpoint as shown in Figure 5.3.
- Open the Algorithmic Debugger window and add a breakpoint using the right click menu of Breakpoints Browser window.

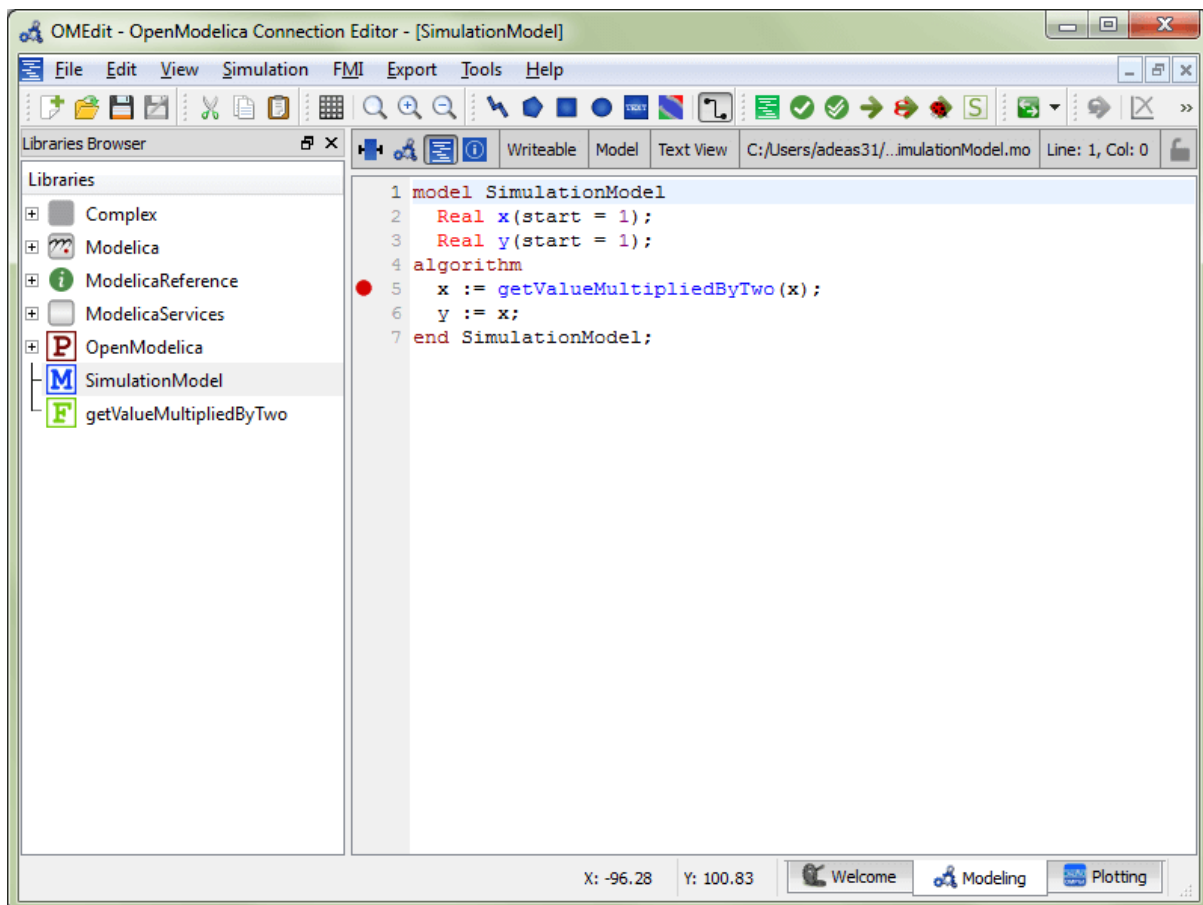

Figure 5.3: Adding breakpoint in Text View.

5.2.2 Start the Algorithmic Debugger

You should add breakpoints before starting the debugger because sometimes the simulation finishes quickly and you won't get any chance to add the breakpoints.

There are four ways to start the debugger,

- Open the Simulation Setup and click on Launch Algorithmic Debugger before pressing Simulate.
- Right click the model in Libraries Browser and select Simulate with Algorithmic Debugger.
- Open the Algorithmic Debugger window and from menu select Debug-> *Debug Configurations*.
- Open the Algorithmic Debugger window and from menu select Debug-> *Attach to Running Process*.

5.2.3 Debug Configurations

If you already have a simulation executable with debugging symbols outside of OMEdit then you can use the Debug->Debug Configurations option to load it.

The debugger also supports MetaModelica data structures so one can debug omc executable. Select omc executable as program and write the name of the mos script file in Arguments.

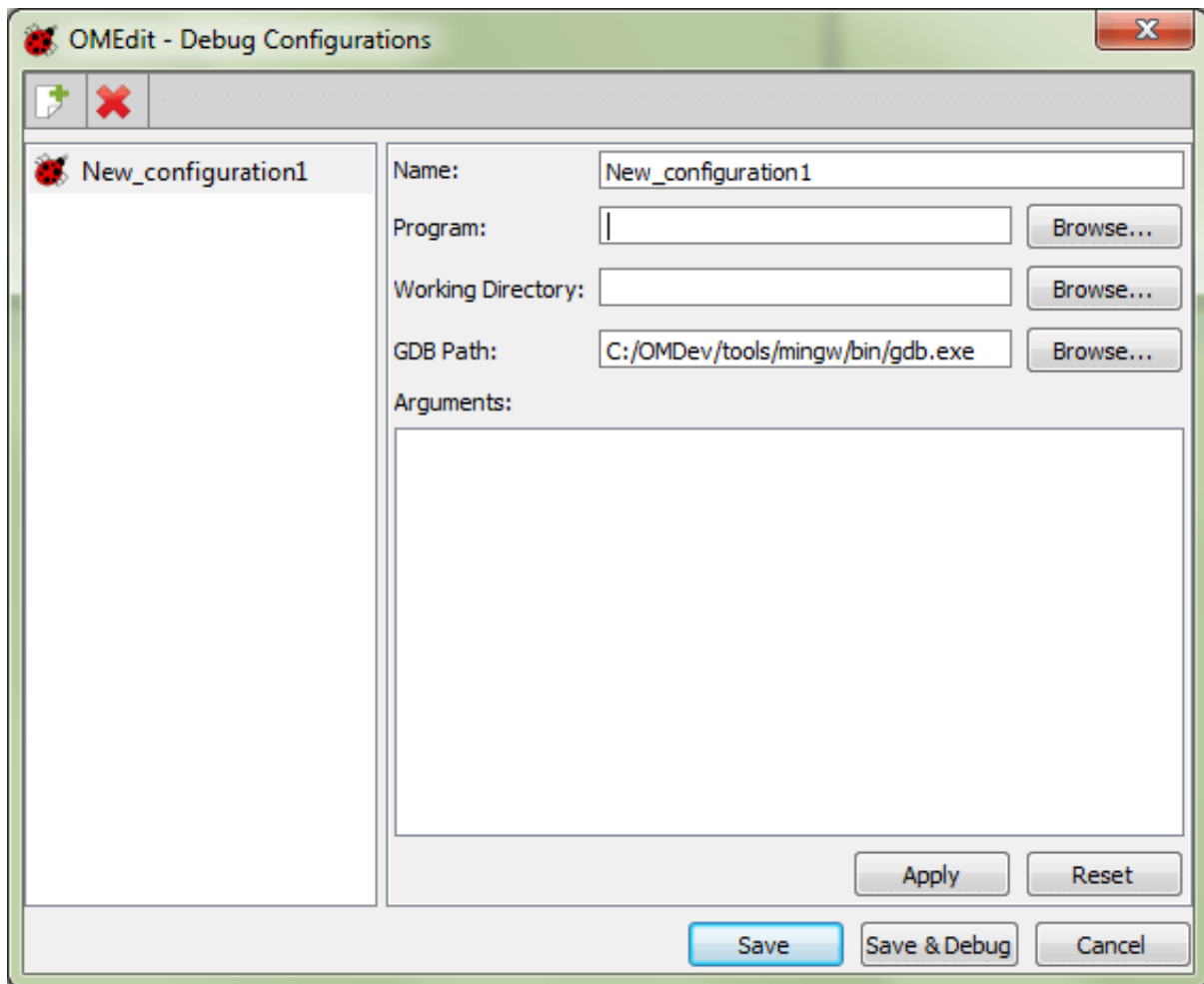

Figure 5.4: Debug Configurations.

5.2.4 Attach to Running Process

If you already have a running simulation executable with debugging symbols outside of OMEdit then you can use the Debug->Attach to Running Process option to attach the debugger with it. Figure 5.5 shows the Attach to Running Process dialog. The dialog shows the list of processes running on the machine. The user selects the program that he/she wish to debug. OMEdit debugger attaches to the process.

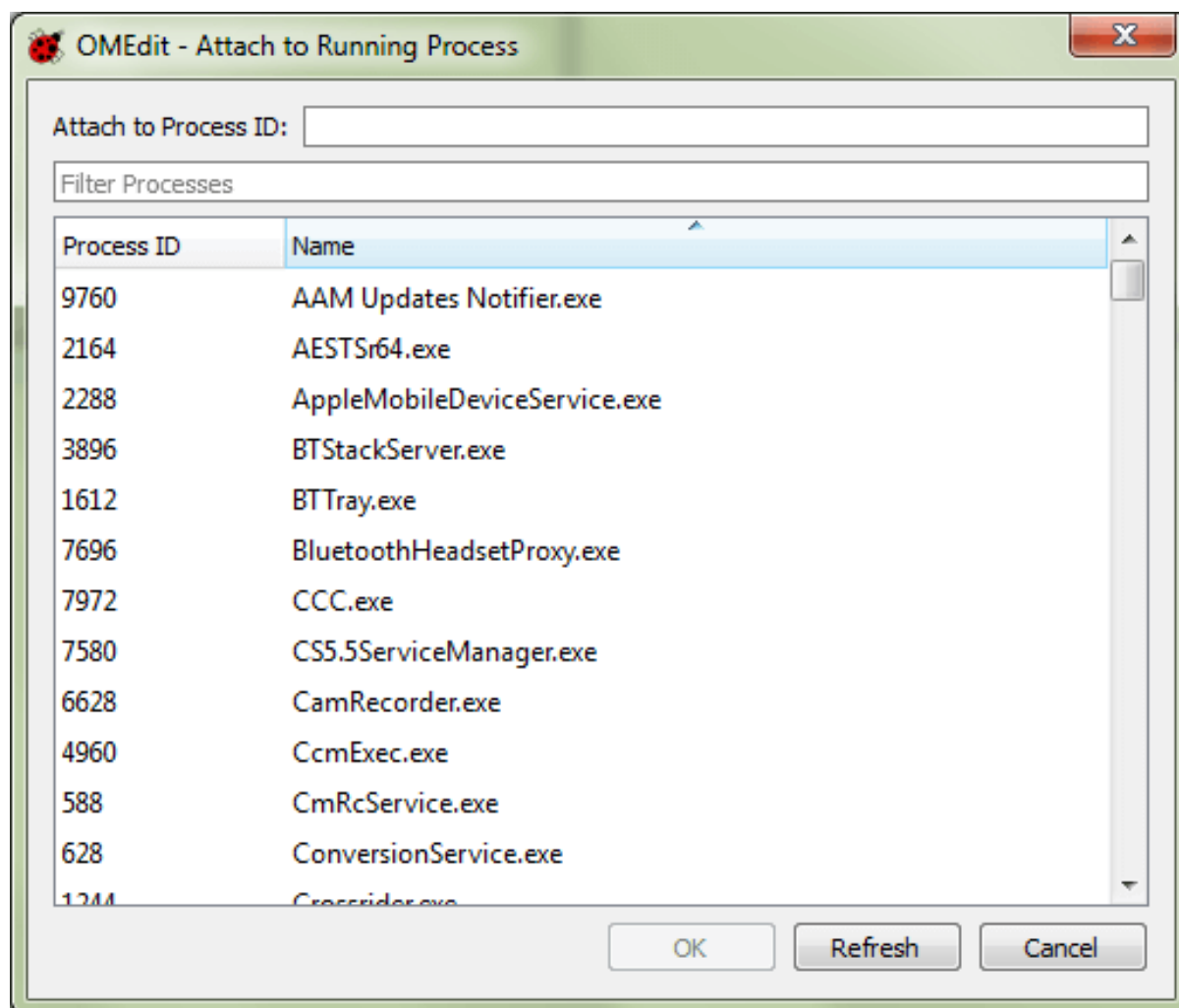

Figure 5.5: Attach to Running Process.

5.2.5 Using the Algorithmic Debugger Window

Figure 5.6 shows the Algorithmic Debugger window. The window contains the following browsers,

- *Stack Frames Browser* – shows the list of frames. It contains the program context buttons like resume, interrupt, exit, step over, step in, step return. It also contains a threads drop down which allows switching between different threads.
- *BreakPoints Browser* – shows the list of breakpoints. Allows adding/editing/removing breakpoints.
- *Locals Browser* – Shows the list of local variables with values. Select the variable and the value will be shown in the bottom right window. This is just for convenience because some variables might have long values.
- *Debugger CLI* – shows the commands sent to gdb and their responses. This is for advanced users who want to have more control of the debugger. It allows sending commands to gdb.
- *Output Browser* – shows the output of the debugged executable.

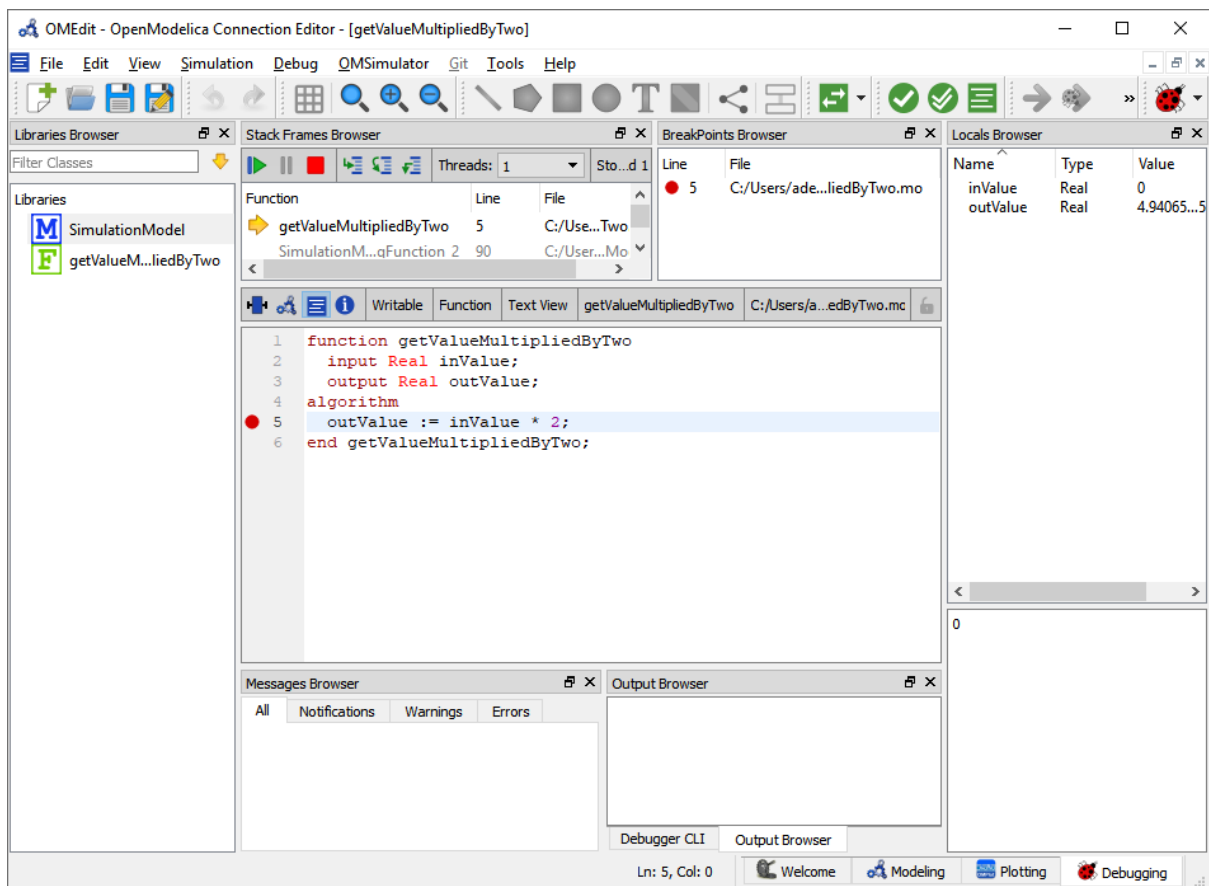

Figure 5.6: Algorithmic Debugger.

GENERATING GRAPH REPRESENTATIONS FOR MODELS

The system of equations after symbolic transformation is represented by a graph. OpenModelica can generate graph representations which can be displayed in the graph tool *yed* (<http://www.yworks.com/products/yed>). The graph generation is activated with the debug flag

`+d=graphml`

Two different graphml- files are generated in the working directory. *TaskGraph_model.graphml*, showing the strongly-connected components of the model and *BipartiteGraph_CompleteDAE_model.graphml* showing all variables and equations. When loading the graphs with *yEd*, all nodes are in one place. Please use the various layout algorithms to get a better overview.



Figure 6.1: A task-graph representation of a model in yEd

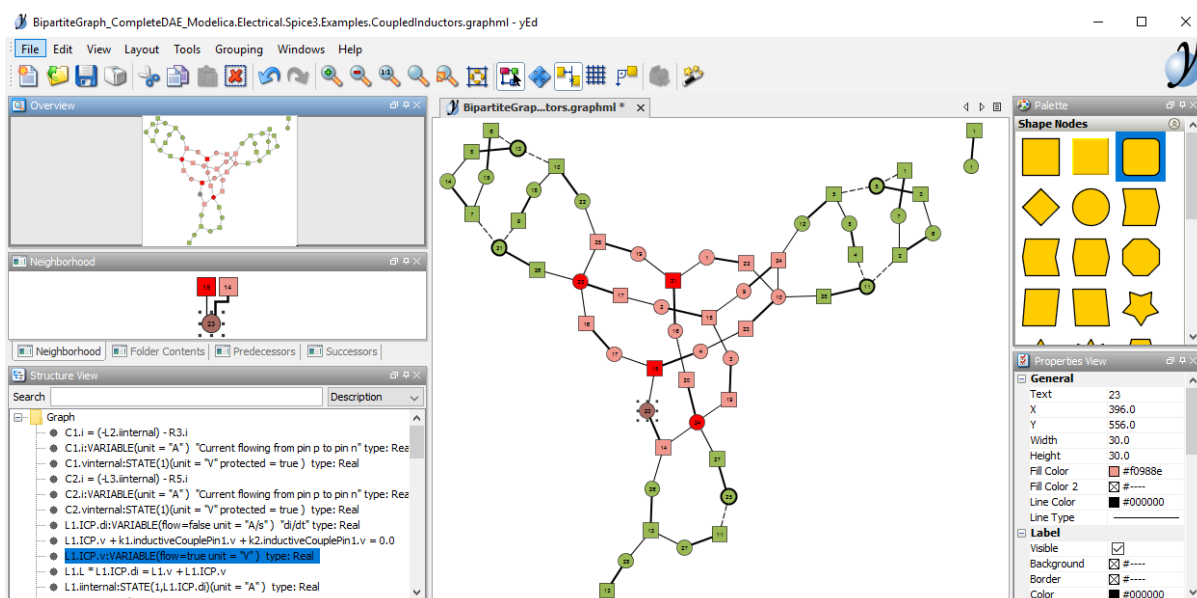

Figure 6.2: A bipartite graph representation of a model in yEd

FMI AND TLM-BASED SIMULATION AND CO-SIMULATION OF EXTERNAL MODELS

7.1 Functional Mock-up Interface - FMI

The new standard for model exchange and co-simulation with Functional Mockup Interface (FMI) allows export of pre-compiled models, i.e., C-code or binary code, from a tool for import in another tool, and vice versa. The FMI standard is Modelica independent. Import and export works both between different Modelica tools, or between certain non-Modelica tools.

See also [OMSimulator documentation](#).

7.1.1 FMI Export

To export the FMU use the OpenModelica command `translateModelFMU(ModelName)` from command line interface, OMSshell, OMNotebook or MDT. The export FMU command is also integrated with OMEdit. Select *File* > *Export* > *FMU* the FMU package is generated in the current directory of omc. You can use the `cd()` command to see the current location. You can set which version of FMI to export through OMEdit settings, see section *FMI*.

To export the bouncing ball example to an FMU, use the following commands:

```
>>> loadFile(getInstallationDirectoryPath() + "/share/doc/omc/testmodels/  
↪BouncingBall.mo")  
true  
>>> translateModelFMU(BouncingBall)  
"«DOCHOME»/BouncingBall.fmu"  
>>> system("unzip -l BouncingBall.fmu | egrep -v 'sources|files' | tail -n+3 |  
↪grep -o '[A-Za-z._0-9/]*$' > BB.log")  
0
```

After the command execution is complete you will see that a file `BouncingBall.fmu` has been created. Its contents varies depending on the current platform. On the machine generating this documentation, the contents in [Listing 7.1](#) are generated (along with the C source code).

Listing 7.1: BouncingBall FMU contents

```
binaries/  
binaries/linux64/  
binaries/linux64/BouncingBall_FMU.libs  
binaries/linux64/BouncingBall.so  
modelDescription.xml
```

A log file for FMU creation is also generated named `ModelName_FMU.log`. If there are some errors while creating FMU they will be shown in the command line window and logged in this log file as well.

By default an FMU that can be used for both Model Exchange and Co-Simulation is generated. We support FMI 1.0 & FMI 2.0 for Model Exchange FMUs and FMI 2.0 for Co-Simulation FMUs.

Currently the Co-Simulation FMU uses the forward Euler solver as default with root finding which does an Euler step of communicationStepSize in fmi2DoStep. Events are checked for before and after the call to fmi2GetDerivatives.

For FMI 2.0 for Co-Simulation OpenModelica can export an experimental implementation of SUNDIALS CVODE (see¹) as internal integrator.

To export a Co-Simulation FMU with CVODE for the bouncing ball example use the following commands:

```
>>> loadFile(getInstallationDirectoryPath() + "/share/doc/omc/testmodels/
↳BouncingBall.mo")
true
>>> setCommandLineOptions("--fmiFlags=s:cvode")
true
>>> translateModelFMU(BouncingBall, version = "2.0", fmuType="cs")
"«DOCHOME»/BouncingBall.fmu"
>>> system("unzip -cqq BouncingBall.fmu resources/BouncingBall_flags.json >
↳BouncingBall_flags.json")
0
```

The FMU BouncingBall.fmu will have a new file BouncingBall_flags.json in its resources directory. By manually changing its content users can change the solver method without recompiling the FMU.

The BouncingBall_flags.json for this example is displayed in Listing 7.2.

Listing 7.2: BouncingBall FMI flags

```
{
  "s" : "cvode"
}
```

For this to work OpenModelica will export all needed dependencies into the FMU if and only if the flag fmiFlags was set. To have CVODE in a SourceCode FMU the user needs to add all sources for SUNDIALS manually and create a build script as well.

7.1.2 FMI Import

To import the FMU package use the OpenModelica command importFMU,

```
>>> list(OpenModelica.Scripting.importFMU, interfaceOnly=true)
function importFMU
  input String filename "the fmu file name";
  input String workdir = "<default>" "The output directory for imported FMU files.
↳<default> will put the files to current working directory.";
  input Integer loglevel = 3 "loglevel_nothing=0;loglevel_fatal=1;loglevel_error=2;
↳loglevel_warning=3;loglevel_info=4;loglevel_verbose=5;loglevel_debug=6";
  input Boolean fullPath = false "When true the full output path is returned,
↳otherwise only the file name.";
  input Boolean debugLogging = false "When true the FMU's debug output is printed.
↳";
  input Boolean generateInputConnectors = true "When true creates the input,
↳connector pins.";
  input Boolean generateOutputConnectors = true "When true creates the output,
↳connector pins.";
  output String generatedFileName "Returns the full path of the generated file.";
end importFMU;
```

The command could be used from command line interface, OMSHELL, OMNotebook or MDT. The importFMU command is also integrated with OMEdit. Select *File > Import > FMU* the FMU package is extracted in the directory specified by workdir, since the workdir parameter is optional so if its not specified then the current directory of omc is used. You can use the cd() command to see the current location.

¹ Sundials Webpage

The implementation supports FMI for Model Exchange 1.0 & 2.0 and FMI for Co-Simulation 1.0 stand-alone. The support for FMI Co-Simulation is still under development.

The FMI Import is currently a prototype. The prototype has been tested in OpenModelica with several examples. It has also been tested with example FMUs from FMUSDK and Dymola. A more complete version for FMI Import will be released in the near future.

When importing the model into OMEdit, roughly the following commands will be executed:

```
>>> loadFile(getInstallationDirectoryPath() + "/share/doc/omc/testmodels/
↳BouncingBall.mo")
true
>>> translateModelFMU(BouncingBall)
"«DOCHOME»/BouncingBall.fmu"
>>> imported_fmu_mo_file:=importFMU("BouncingBall.fmu")
"BouncingBall_me_FMU.mo"
>>> loadFile(imported_fmu_mo_file)
true
```

The imported FMU can then be simulated like any normal model:

```
>>> simulate(BouncingBall_me_FMU, stopTime=3.0)
record SimulationResult
  resultFile = "«DOCHOME»/BouncingBall_me_FMU_res.mat",
  simulationOptions = "startTime = 0.0, stopTime = 3.0, numberOfIntervals = 500,
↳tolerance = 1e-06, method = 'dassl', fileNamePrefix = 'BouncingBall_me_FMU',
↳options = '', outputFormat = 'mat', variableFilter = '.*', cflags = '', simflags_
↳= '',
  messages = "LOG_SUCCESS      | info    | The initialization finished_
↳successfully without homotopy method.
LOG_SUCCESS      | info    | The simulation finished successfully.
",
  timeFrontend = 0.019492489,
  timeBackend = 0.007225032,
  timeSimCode = 0.002870819,
  timeTemplates = 0.015558574,
  timeCompile = 0.477139087,
  timeSimulation = 0.037230584,
  timeTotal = 0.559620759
end SimulationResult;
```

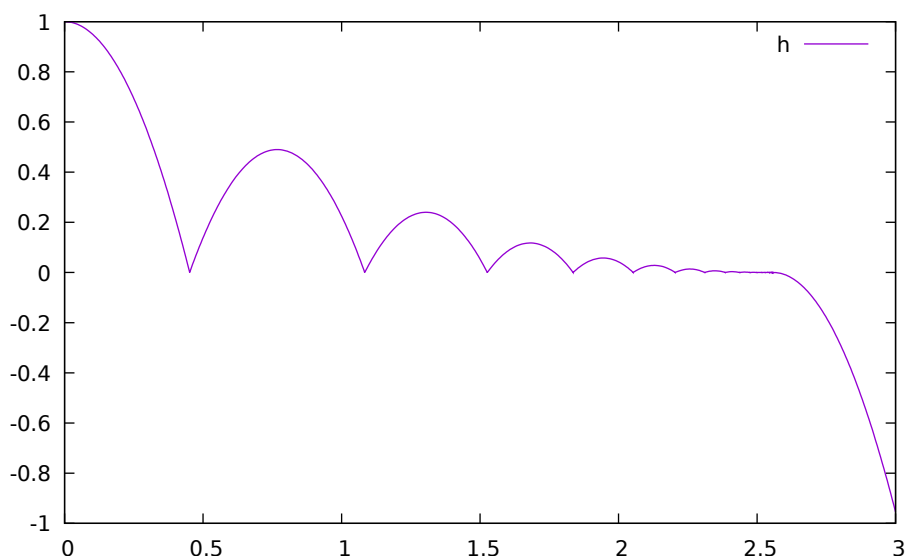

Figure 7.1: Height of the bouncing ball, simulated through an FMU.

7.2 Transmission Line Modeling (TLM) Based Co-Simulation

This chapter gives a short description how to get started using the TLM-Based co-simulation accessible via OMEdit.

The TLM Based co-simulation provides the following general functionalities:

- Import and add External non-Modelica models such as **Matlab/SimuLink**, **Adams**, and **BEAST** models
- Import and add External Modelica models e.g. from tools such as **Dymola** or **Wolfram SystemModeler**, etc.
- Specify startup methods and interfaces of the external model
- Build the composite models by connecting the external models
- Set the co-simulation parameters in the composite model
- Simulate the composite models using TLM based co-simulation

7.3 Composite Model Editing of External Models

The graphical composite model editor is an extension and specialization of the OpenModelica connection editor OMEdit. A composite model is composed of several external sub-models including the interconnections between these sub-models. External models are models which need not be in Modelica, they can be FMUs, or models accessed by proxies for co-simulation and connected by TLM-connections. The standard way to store a composite model is in an XML format. The XML schema standard is accessible from `tlmModelDescription.xsd`. Currently composite models can only be used for TLM based co-simulation of external models.

7.3.1 Loading a Composite Model for Co-Simulation

To load the composite model, select **File > Open Composite Model(s)** from the menu and select `composite-model.xml`.

OMEdit loads the composite model and show it in the **Libraries Browser**. Double-clicking the composite model in the **Libraries Browser** will display the composite model as shown below in [Figure 7.2](#).

7.3.2 Co-Simulating the Composite Model

There are two ways to start co-simulation:

- Click **TLM Co-Simulation setup button** () from the toolbar (requires a composite model to be active in ModelWidget)
- Right click the composite model in the **Libraries Browser** and choose **TLM Co-Simulation setup** from the popup menu (see [Figure 7.3](#))

The TLM Co-Simulation setup appears as shown below in [Figure 7.4](#).

Click **Simulate** from the Co-simulation setup to confirm the co-simulation. [Figure 7.5](#) will appear in which you will be able to see the progress information of the running co-simulation.

The editor also provides the means of reading the log files generated by the simulation manager and monitor. When the simulation ends, click **Open Manager Log File** or **Open Monitor Log File** from the co-simulation progress bar to check the log files.

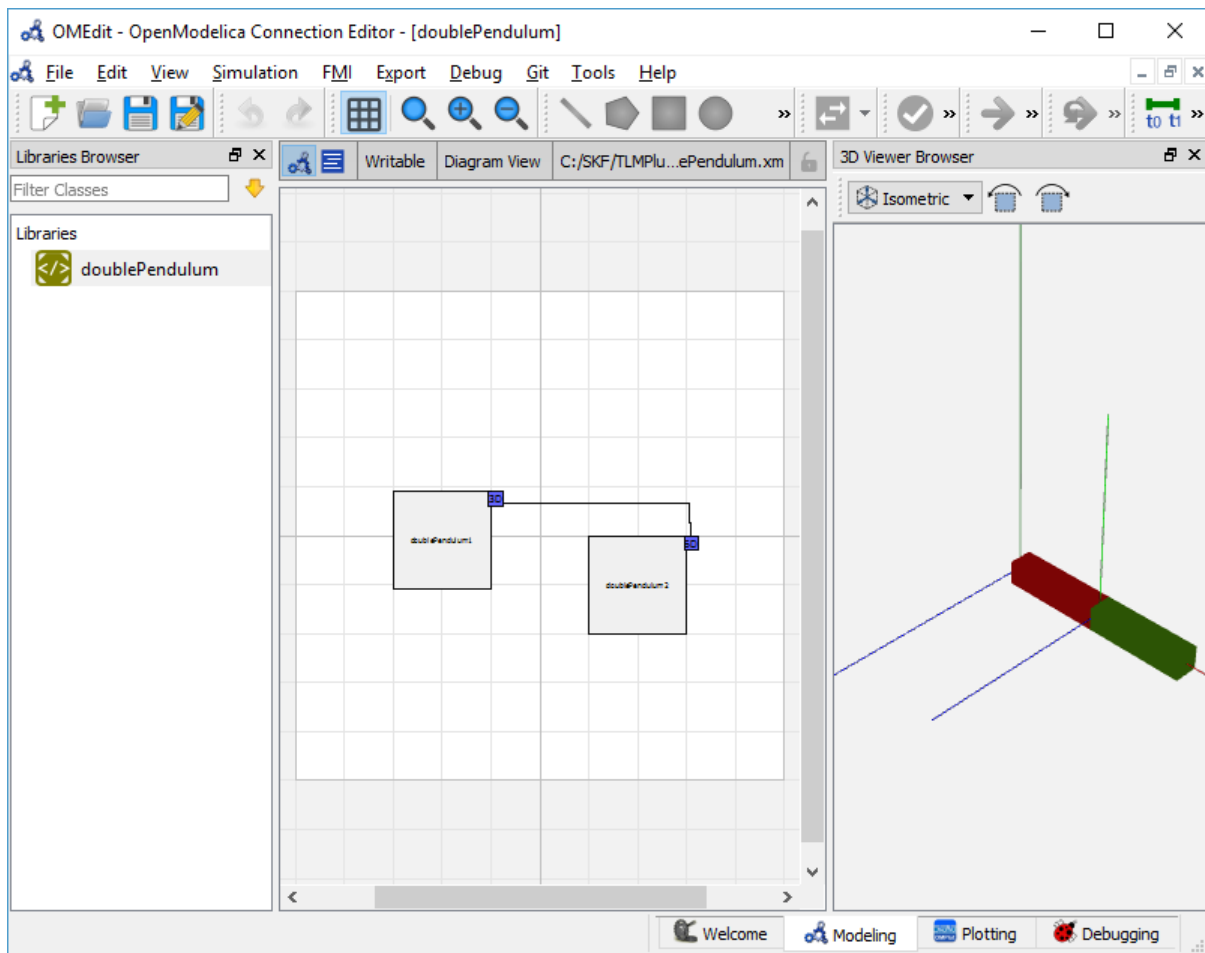

Figure 7.2: Composite Model with 3D View.

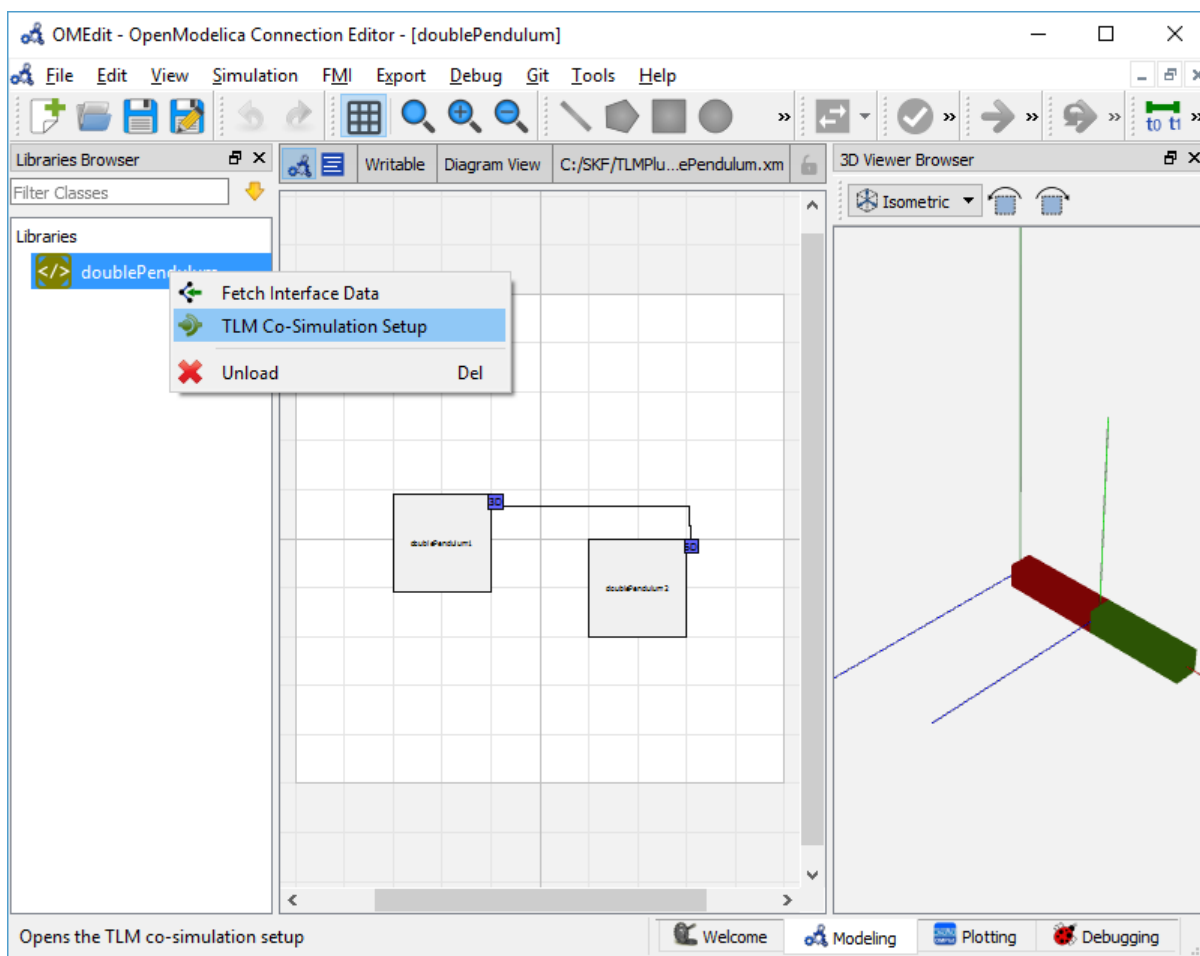

Figure 7.3: Co-simulating and Fetching Interface Data of a composite model from the Pop-up Menu .

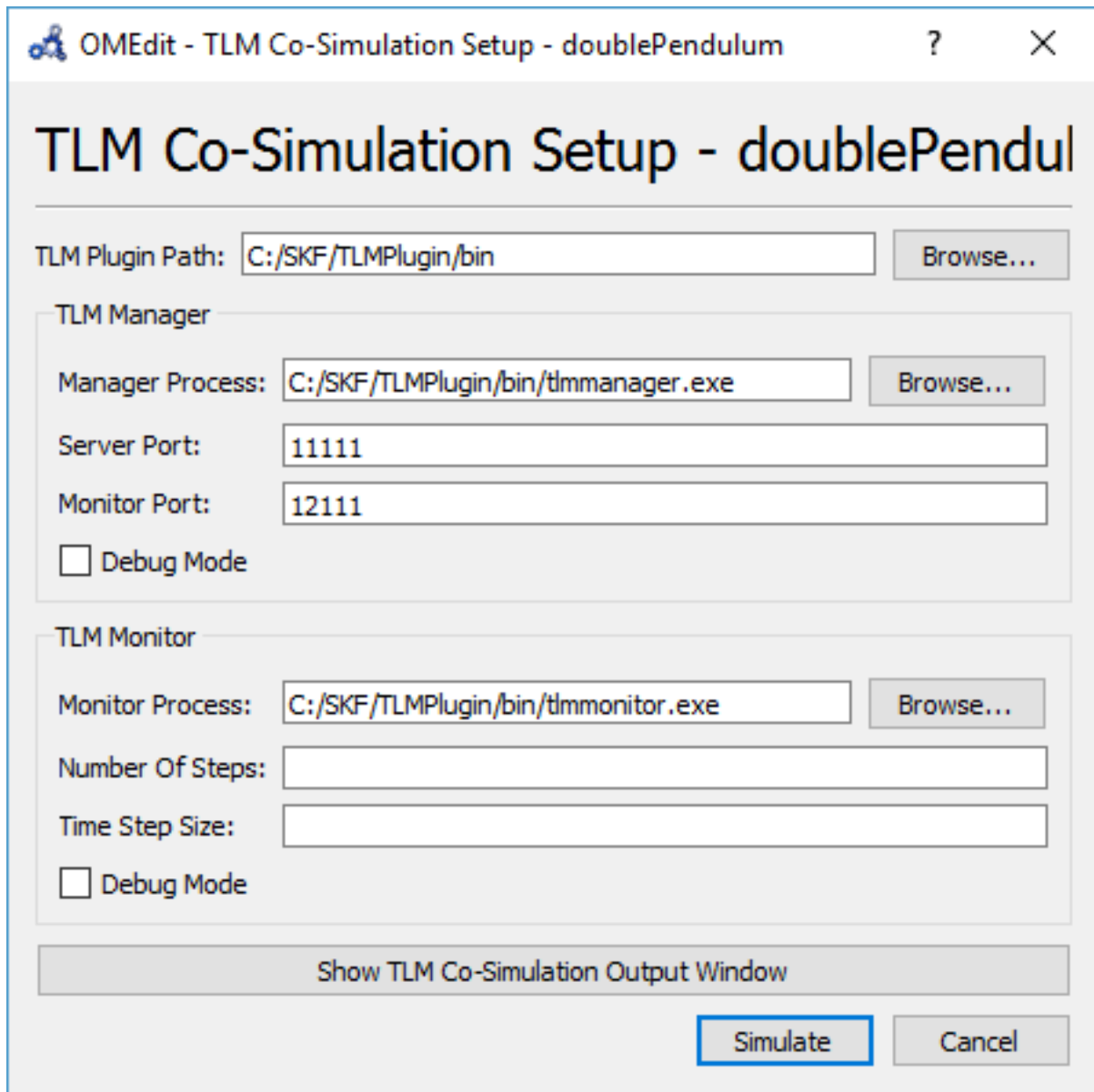

Figure 7.4: TLM Co-simulation Setup.

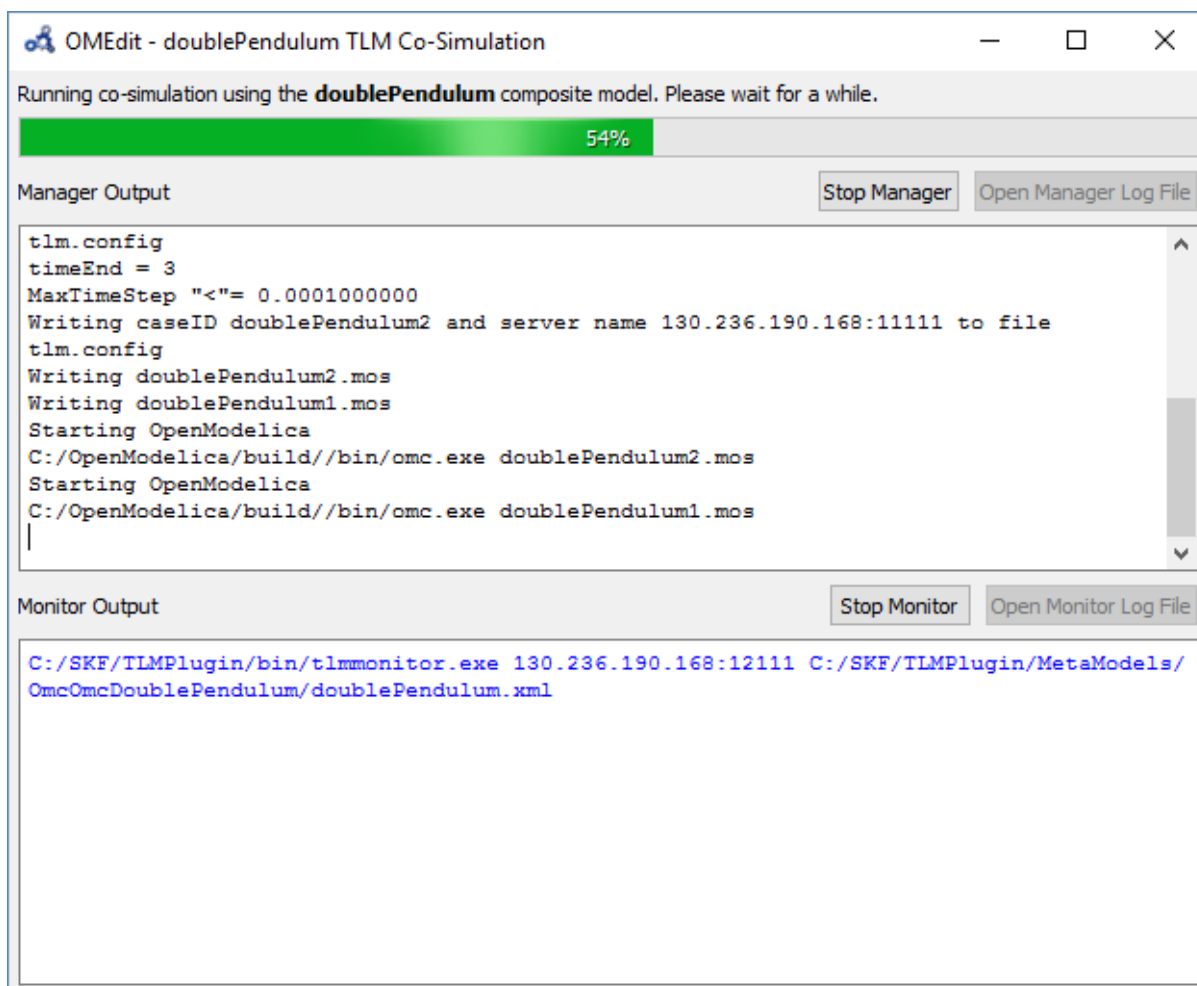

Figure 7.5: TLM Co-Simulation Progress.

7.3.3 Plotting the Simulation Results

When the co-simulation of the composite model is completed successful, simulation results are collected and visualized in the OMEdit plotting perspective as shown in Figure 7.6 and Figure 7.7. The **Variables Browser** display variables that can be plotted. Each variable has a checkbox, checking it will plot the variable.

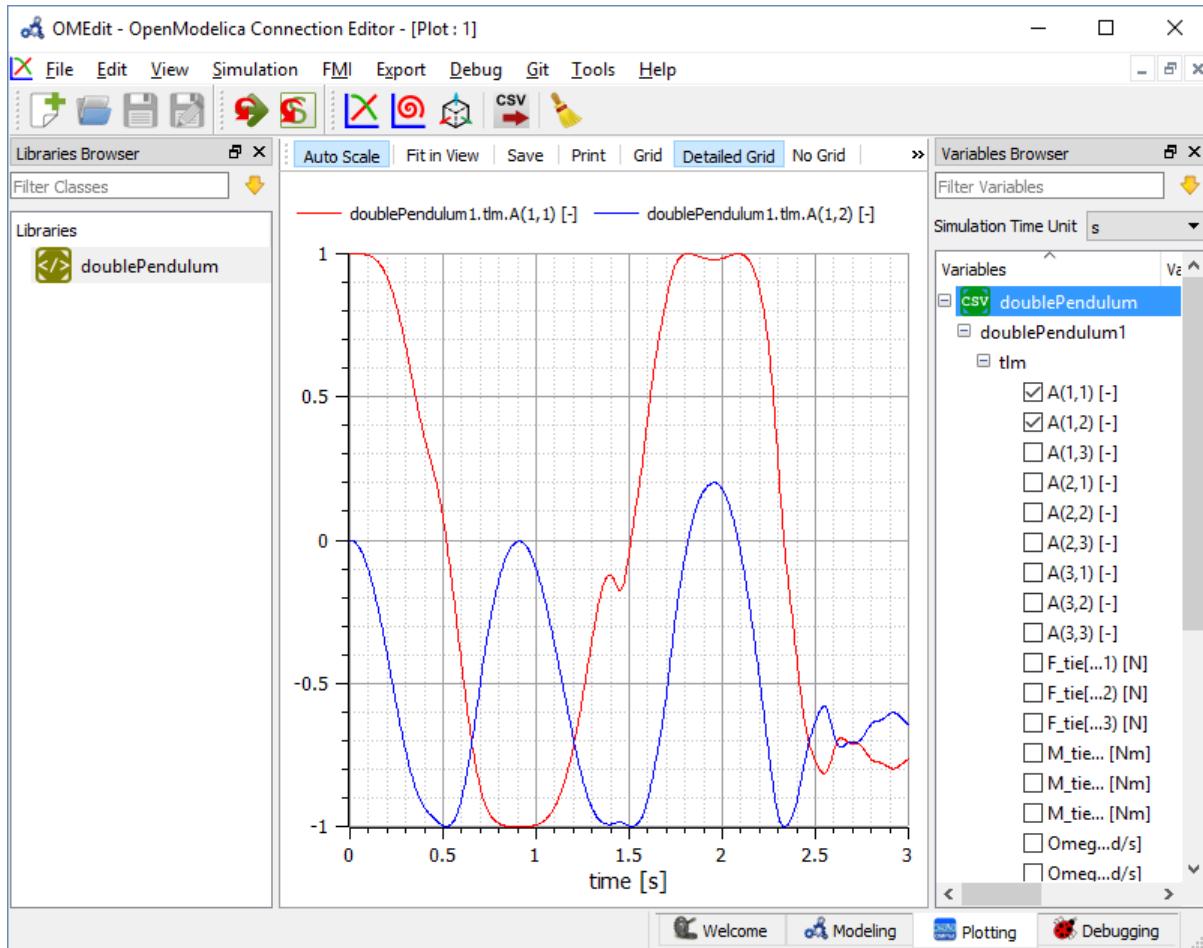

Figure 7.6: TLM Co-Simulation Results Plotting.

7.3.4 Preparing External Models

First step in co-simulation Modeling is to prepare the different external simulation models with TLM interfaces. Each external model belongs to a specific simulation tool, such as **MATLAB/Simulink***, **BEAST**, **MSC/ADAMS**, **Dymola** and **Wolfram SystemModeler**.

When the external models have all been prepared, the next step is to load external models in OMEdit by selecting the **File > Load External Model(s)** from the menu.

OMEdit loads the external model and show it in the **Libraries Browser** as shown below in Figure 7.8.

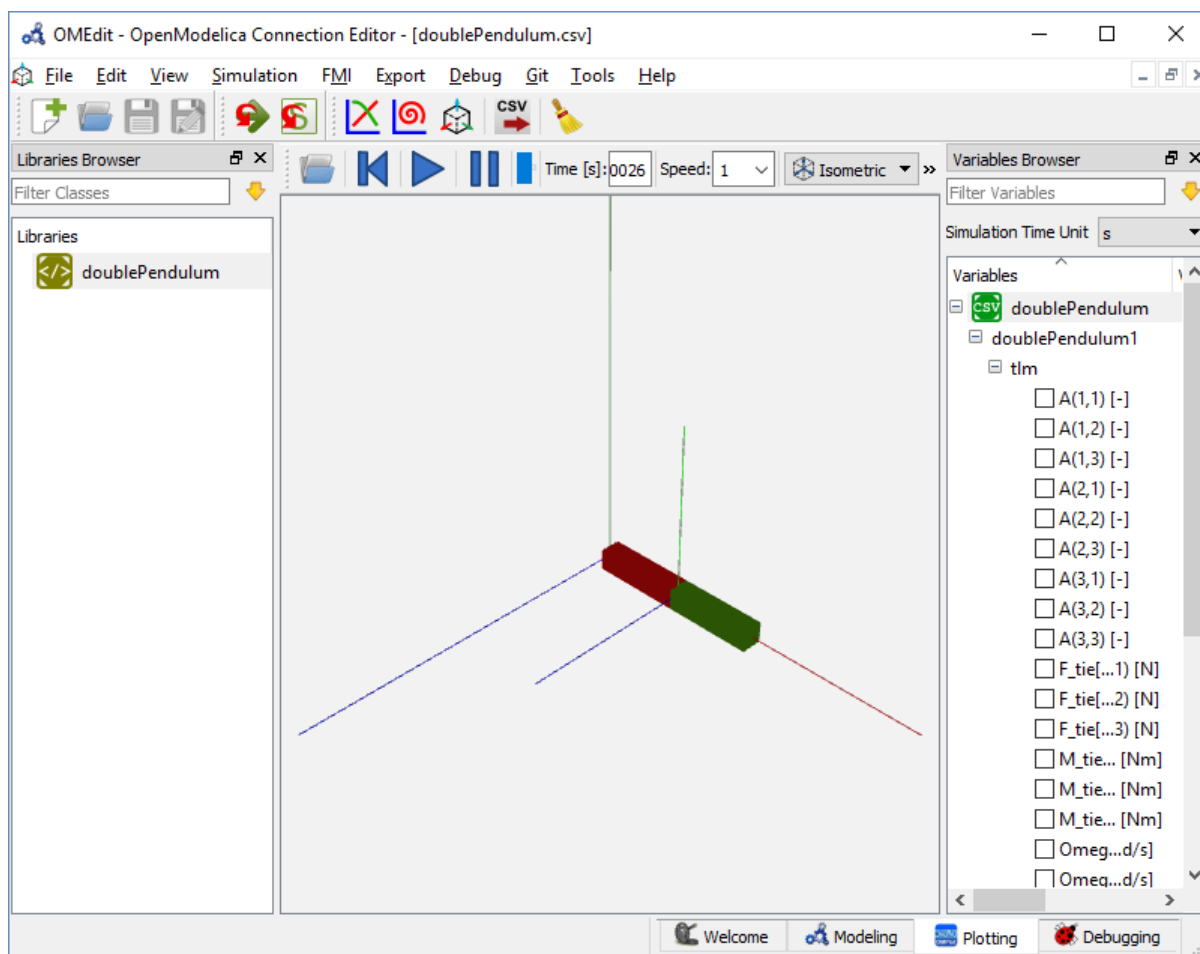

Figure 7.7: TLM Co-Simulation Visualization.

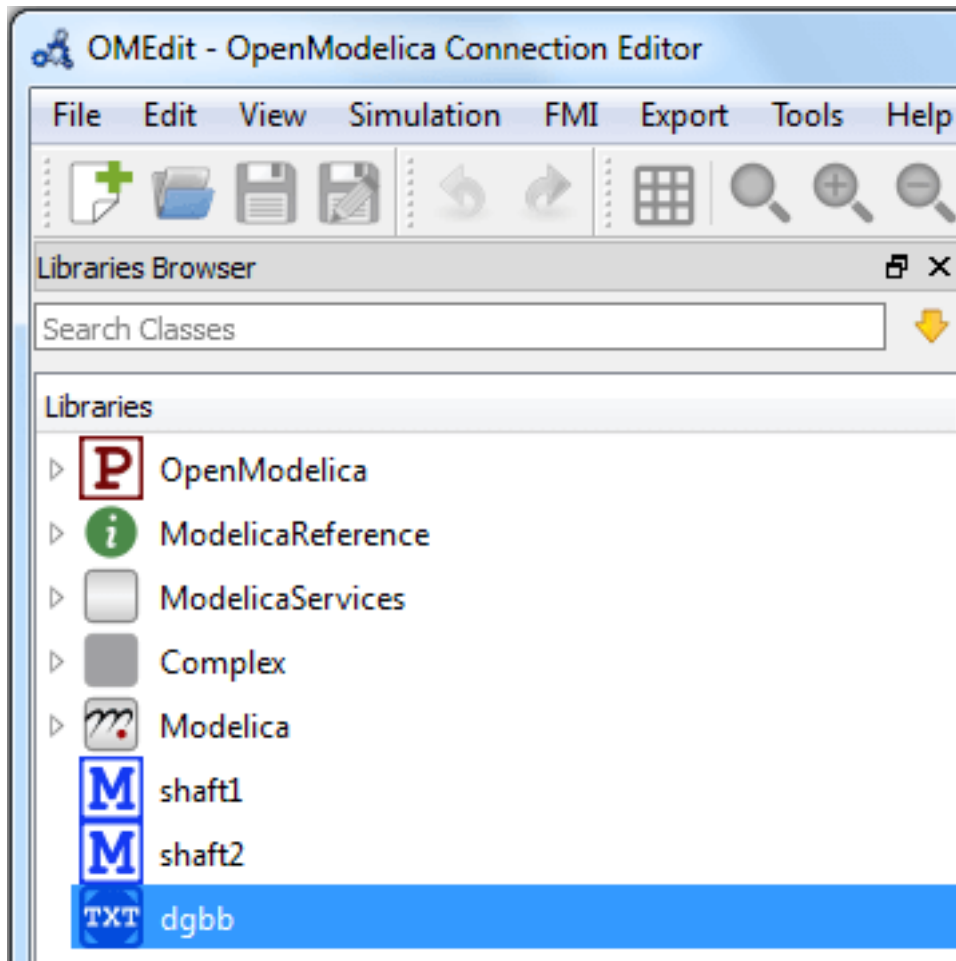

Figure 7.8: External Models in OMEdit.

7.3.5 Creating a New Composite Model

We will use the "Double pendulum" composite model which is a multibody system that consists of three sub-models: Two OpenModelica **Shaft** sub-models (**Shaft1** and **Shaft2**) and one **SKF/BEAST bearing** sub-model that together build a double pendulum. The **SKF/BEAST bearing** sub-model is a simplified model with only three balls to speed up the simulation. **Shaft1** is connected with a spherical joint to the world coordinate system. The end of **Shaft1** is connected via a TLM interface to the outer ring of the BEAST bearing model. The inner ring of the bearing model is connected via another TLM interface to **Shaft2**. Together they build the double pendulum with two **shafts**, one spherical OpenModelica joint, and one BEAST bearing.

To create a new composite model select **File > New Composite Model** from the menu.

Your new composite model will appear in the in the **Libraries Browser** once created. To facilitate the process of textual composite modeling and to provide users with a starting point, the **Text View** (see [Figure 7.9](#)) includes the composite model XML elements and the default simulation parameters.

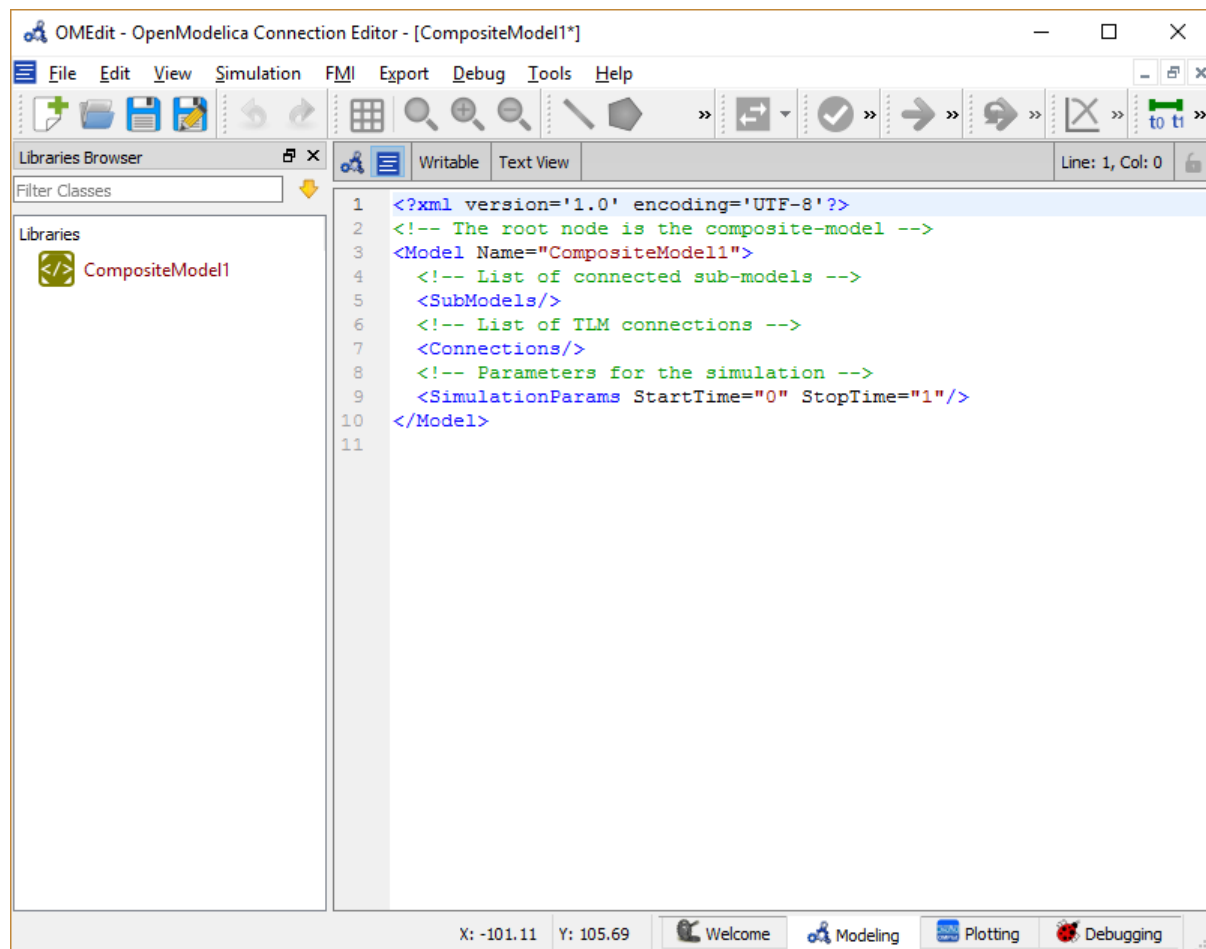

Figure 7.9: New composite model text view.

7.3.6 Adding Submodels

It is possible to build the double pendulum by drag-and-drop of each simulation model component (sub-model) from the **Libraries Browser** to the Diagram View. To place a component in the Diagram View of the double pendulum model, drag each external sub-model of the double pendulum (i.e. **Shaft1**, **Shaft2**, and **BEAST bearing** sub-model) from the **Libraries Browser** to the **Diagram View**.

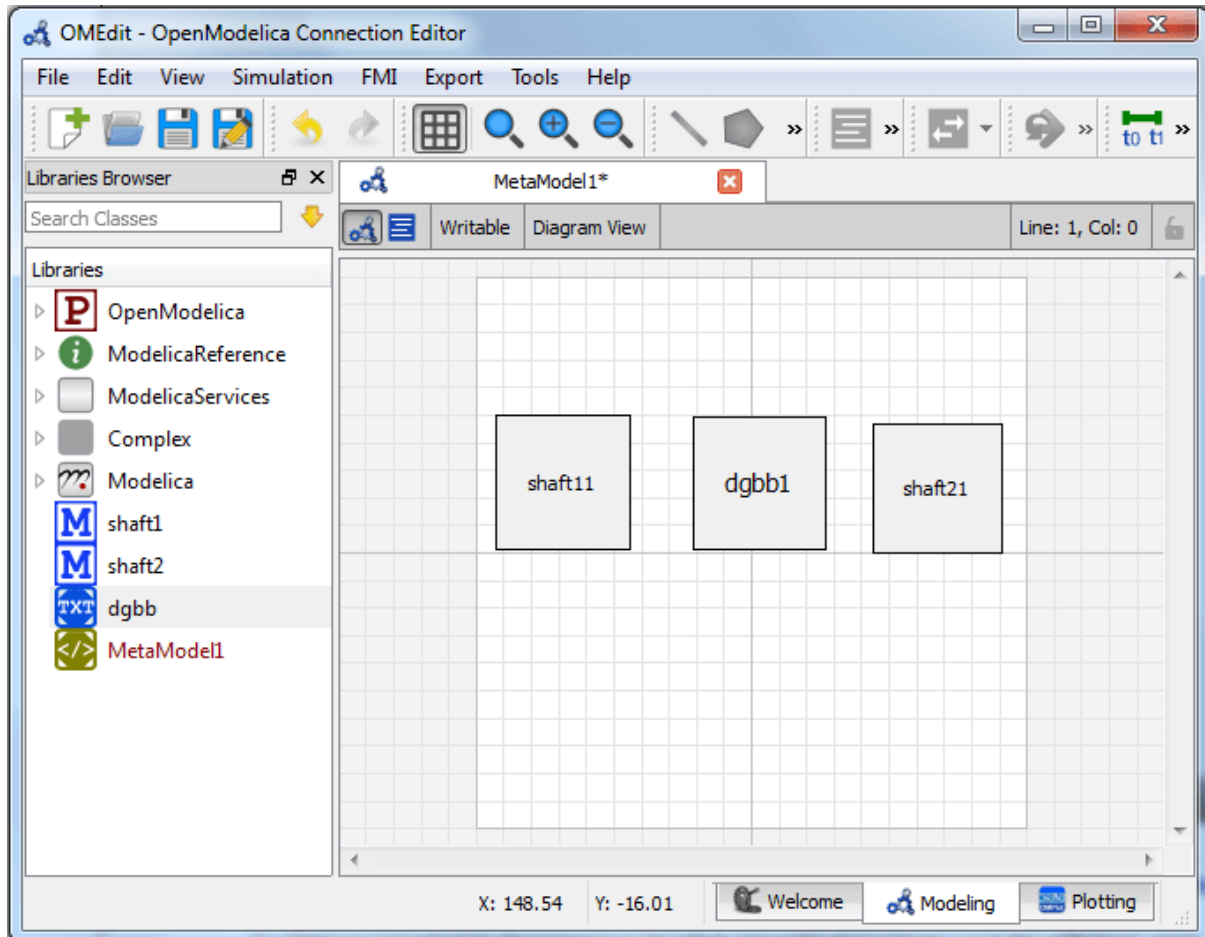

Figure 7.10: Adding sub-models to the double pendulum composite model.

7.3.7 Fetching Submodels Interface Data

To retrieve list of TLM interface data for sub-models, do any of the following methods:

- Click **Fetch Interface Data** button (🔄) from the toolbar (requires a composite model to be active in ModelWidget)
- Right click the composite model in the **Library Browser** and choose **Fetch Interface Data** from the popup menu (see Figure 7.3).

To retrieve list of TLM interface data for a specific sub-model,

- Right click the sub-model inside the composite model and choose **Fetch Interface Data** from the popup menu.

Figure 7.11 will appear in which you will be able to see the progress information of fetching the interface data.

Once the TLM interface data of the sub-models are retrieved, the interface points will appear in the diagram view as shown below in Figure 7.12.

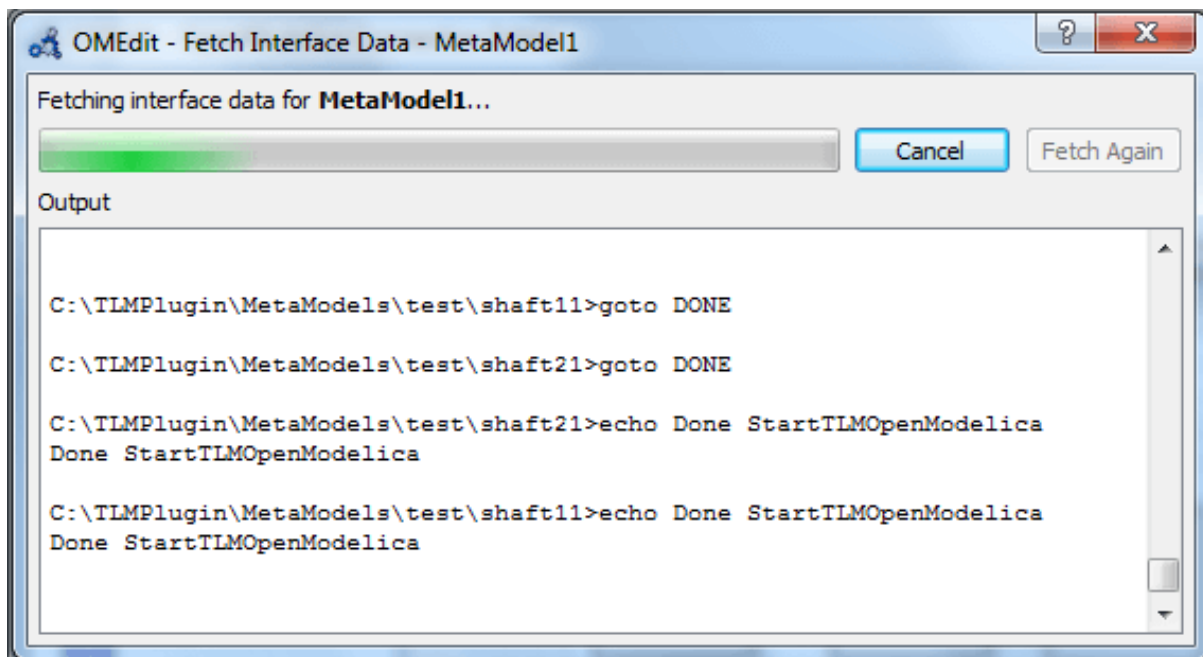



Figure 7.11: Fetching Interface Data Progress.

7.3.8 Connecting Submodels

When the sub-models and interface points have all been placed in the Diagram View, similar to [Figure 7.12](#), the next step is to connect the sub-models. Sub-models are connected using the **Connection Line Button** () from the toolbar.

To connect two sub-models, select the Connection Line Button and place the mouse cursor over an interface and click the left mouse button, then drag the cursor to the other sub-model interface, and click the left mouse button again. A connection dialog box as shown below in [Figure 7.13](#) will appear in which you will be able to specify the connection attributes.

Continue to connect all sub-models until the composite model **Diagram View** looks like the one in [Figure 7.14](#) below.

7.3.9 Changing Parameter Values of Submodels

To change a parameter value of a sub-model, do any of the following methods:

- Double-click on the sub-model you want to change its parameter
- Right click on the sub-model and choose **Attributes** from the popup menu

The parameter dialog of that sub-model appears as shown below in [Figure 7.15](#) in which you will be able to specify the sub-models attributes.

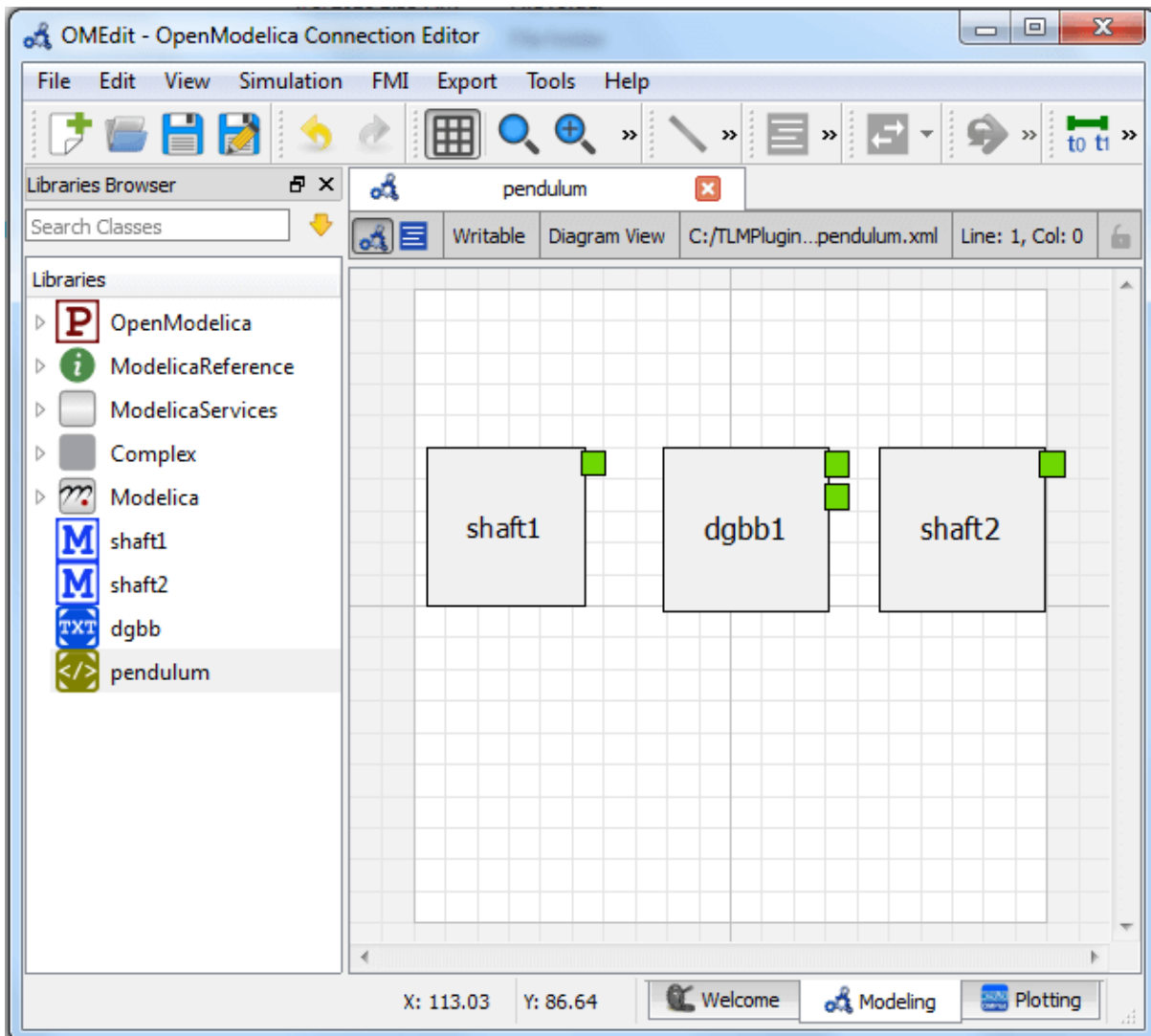

Figure 7.12: Fetching Interface Data.

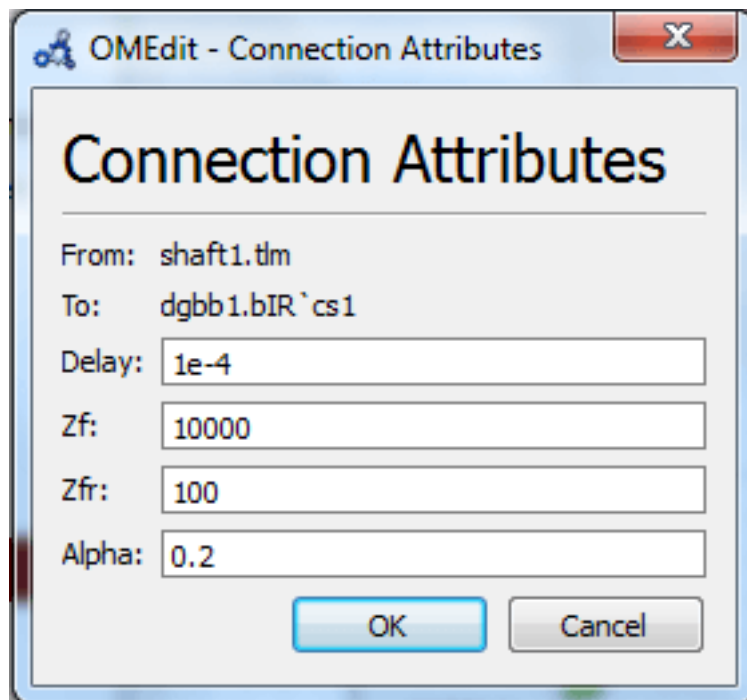

Figure 7.13: Sub-models Connection Dialog.

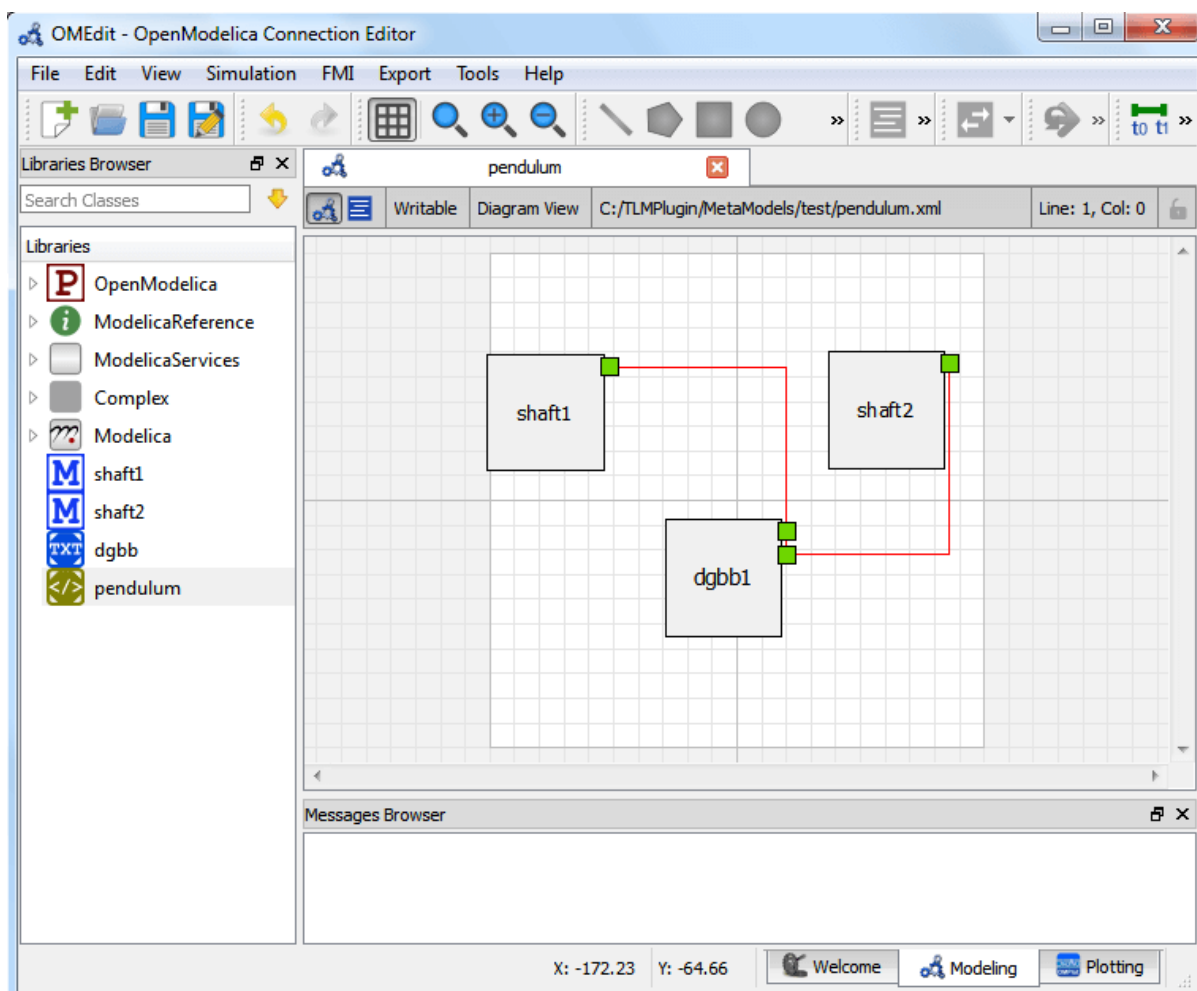

Figure 7.14: Connecting sub-models of the Double Pendulum Composite Model.

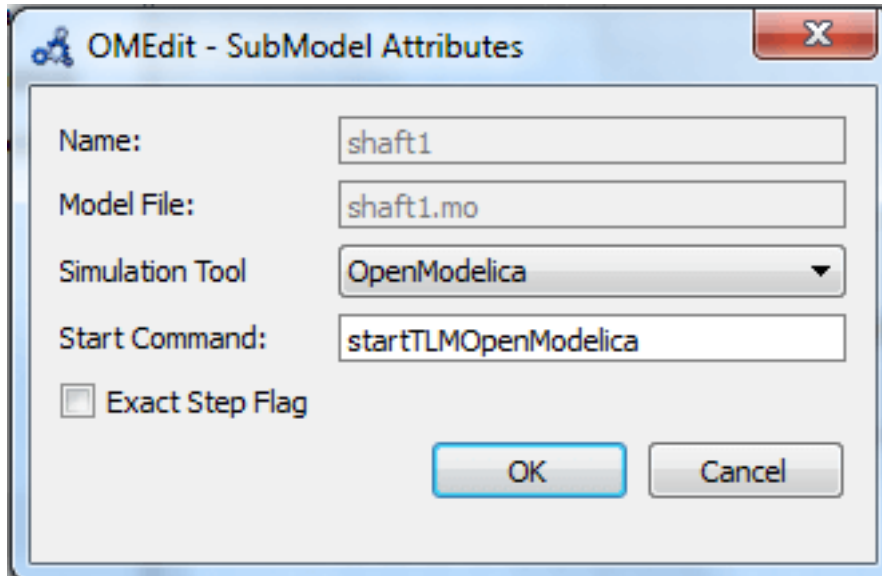

Figure 7.15: Changing Parameter Values of Sub-models Dialog.

7.3.10 Changing Parameter Values of Connections

To change a parameter value of a connection, do any of the following methods:

- Double-click on the connection you want to change its parameter
- Right click on the connection and choose **Attributes** from the popup menu.

The parameter dialog of that connection appears (see [Figure 7.13](#)) in which you will be able to specify the connections attributes.

7.3.11 Changing Co-Simulation Parameters

To change the co-simulation parameters, do any of the following methods:

- Click Simulation Parameters button (to ti) from the toolbar (requires a composite model to be active in ModelWidget)
- Right click an empty location in the Diagram View of the composite model and choose **Simulation Parameters** from the popup menu (see [Figure 7.16](#))

The co-simulation parameter dialog of the composite model appears as shown below in [Figure 7.17](#) in which you will be able to specify the simulation parameters.

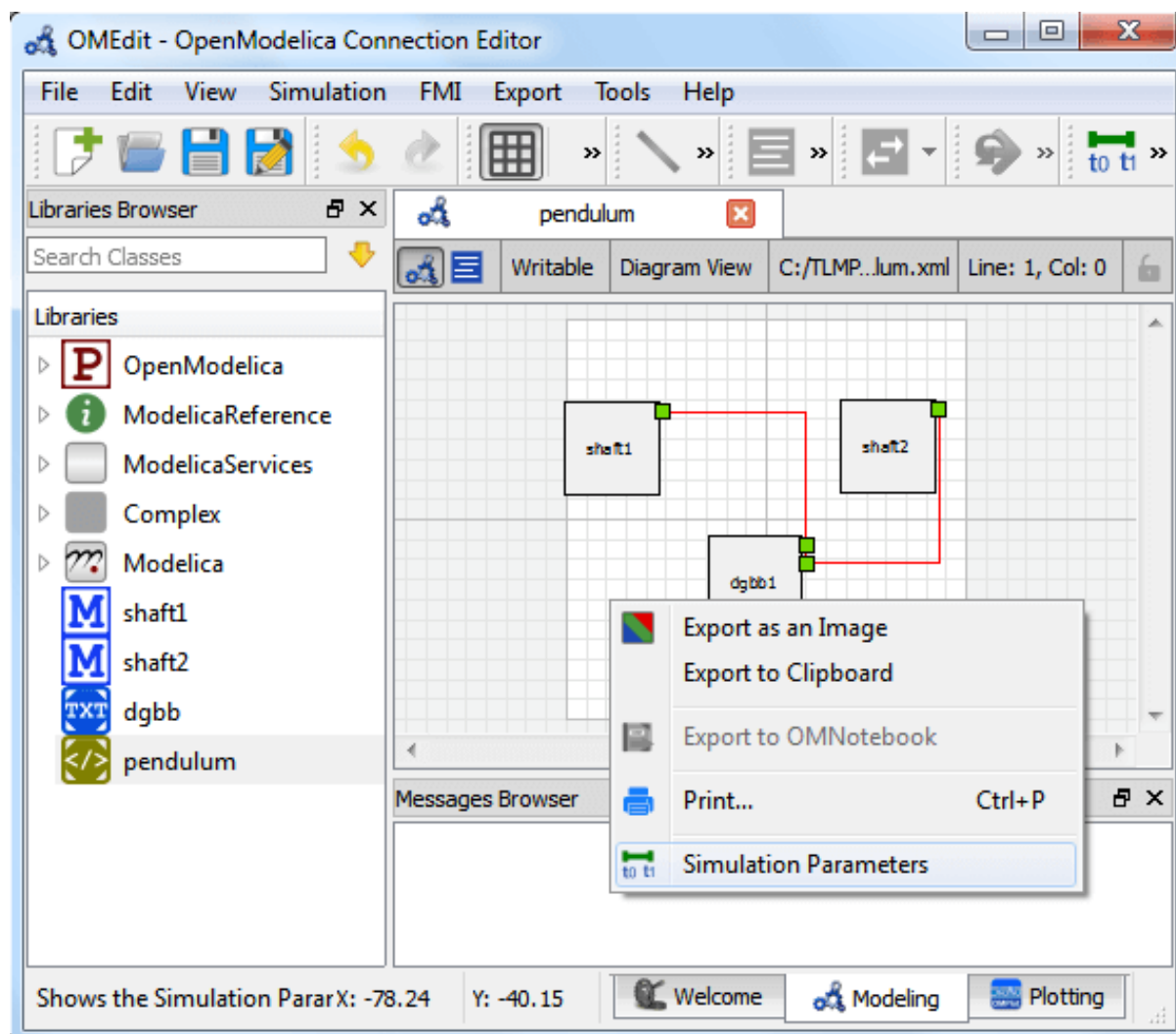

Figure 7.16: Changing Co-Simulation Parameters from the Popup Menu.

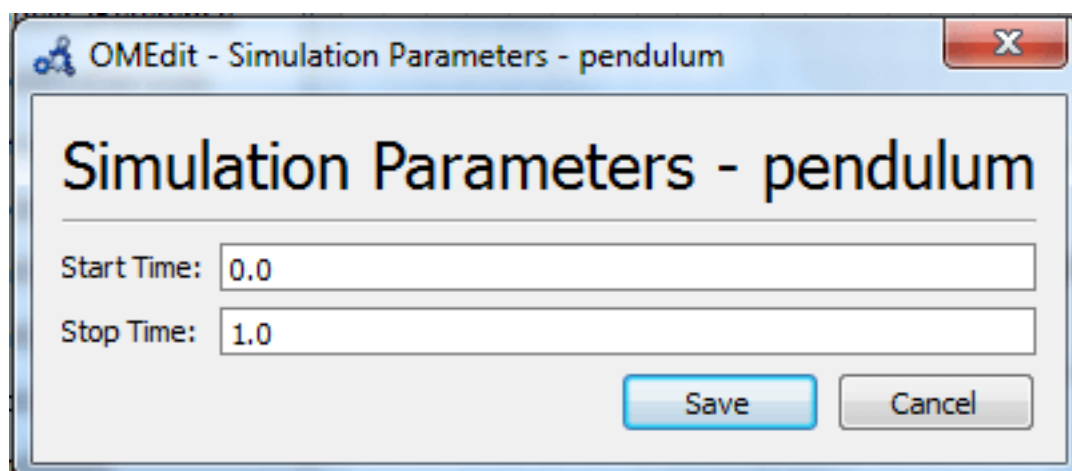

Figure 7.17: Changing Co-Simulation Parameters Dialog.

OMSIMULATOR

Version: v2.1.0-dev-216-g8ce61de

8.1 Introduction

The OMSimulator project is a FMI-based co-simulation tool that supports ordinary (i.e., non-delayed) and TLM connections. It supports large-scale simulation and virtual prototyping using models from multiple sources utilizing the FMI standard. It is integrated into OpenModelica but also available stand-alone, i.e., without dependencies to Modelica specific models or technology. OMSimulator provides an industrial-strength open-source FMI-based modelling and simulation tool. Input/output ports of FMUs can be connected, ports can be grouped to buses, FMUs can be parameterized and composed, and composite models can be exported according to the (preliminary) SSP (System Structure and Parameterization) standard. Efficient FMI based simulation is provided for both model-exchange and co-simulation. TLM-based tool connection is provided for a range of applications, e.g., Adams, Simulink, Beast, Dymola, and OpenModelica. Moreover, optional TLM (Transmission Line Modelling) domain-specific connectors are also supported, providing additional numerical stability to co-simulation. An external API is available for use from other tools and scripting languages such as *Python* and *Lua*.

8.2 OMSimulator

OMSimulator is a command line wrapper for the OMSimulatorLib library.

8.2.1 OMSimulator Flags

A brief description of all command line flags will be displayed using `OMSimulator --help`:

```
info:      Usage: OMSimulator [Options] [Lua script] [FMU] [SSP file]
           Options:
           --addParametersToCSV=<arg>      Export parameters to .csv file (true,
↪[false])
           --clearAllOptions                Reset all flags to default values
           --deleteTempFiles=<bool>        Deletes temp files as soon as they are
↪no longer needed ([true], false)
           --emitEvents=<bool>             Specifies whether events should be
↪emitted or not ([true], false)
           --exportParametersInline=<arg>  Export ParameterBindings inline with .
↪ssd file,
           --fetchAllVars=<arg>            Workaround for certain FMUs that do not
↪update all internal dependencies automatically
           --help [-h]                     Displays the help text
           --ignoreInitialUnknowns=<bool> Ignore the initial unknowns from the
↪modelDescription.xml (true, [false])
           --inputExtrapolation=<bool>     Enables input extrapolation using
↪derivative information (true, [false])
           --intervals=<int> [-i]          Specifies the number of communication
↪points (arg > 1)
```

(continues on next page)

(continued from previous page)

<code>--logfile=<arg> [-l]</code>	Specifies the logfile (stdout is used
<code>↔if no log file is specified)</code>	
<code>--logLevel=<int></code>	0 default, 1 debug, 2 debug+trace
<code>--maxEventIteration=<int></code>	Specifies the max. number of iterations
<code>↔for handling a single event</code>	
<code>--maxLoopIteration=<int></code>	Specifies the max. number of iterations
<code>↔for solving algebraic loops between system-level components. Internal algebraic</code>	
<code>↔loops of components are not affected.</code>	
<code>--mode=<arg> [-m]</code>	Forces a certain FMI mode iff the FMU
<code>↔provides cs and me (cs, [me])</code>	
<code>--numProcs=<int> [-n]</code>	Specifies the max. number of processors
<code>↔to use (0=auto, 1=default)</code>	
<code>--progressBar=<bool></code>	Shows a progress bar for the simulation
<code>↔progress in the terminal (true, [false])</code>	
<code>--realTime=<bool></code>	Experimental feature for (soft) real-
<code>↔time co-simulation (true, [false])</code>	
<code>--resultFile=<arg> [-r]</code>	Specifies the name of the output result
<code>↔file</code>	
<code>--setInputDerivatives=<bool></code>	Deprecated; see '--inputExtrapolation'
<code>--skipCSVHeader=<arg></code>	Skip exporting the csv delimiter in the
<code>↔header (true, [false]),</code>	
<code>--solver=<arg></code>	Specifies the integration method (euler,
<code>↔ [cvsode])</code>	
<code>--solverStats=<bool></code>	Adds solver stats to the result file, e.
<code>↔g. step size; not supported for all solvers (true, [false])</code>	
<code>--startTime=<double> [-s]</code>	Specifies the start time
<code>--stopTime=<double> [-t]</code>	Specifies the stop time
<code>--stripRoot=<bool></code>	Removes the root system prefix from all
<code>↔exported signals (true, [false])</code>	
<code>--suppressPath=<bool></code>	Supresses path information in info
<code>↔messages; especially useful for testing (true, [false])</code>	
<code>--tempDir=<arg></code>	Specifies the temp directory
<code>--timeout=<int></code>	Specifies the maximum allowed time in
<code>↔seconds for running a simulation (0 disables)</code>	
<code>--tolerance=<double></code>	Specifies the relative tolerance
<code>--version [-v]</code>	Displays version information
<code>--wallTime=<bool></code>	Add wall time information for to the
<code>↔result file (true, [false])</code>	
<code>--workingDir=<arg></code>	Specifies the working directory

To use flag `logLevel` with option `debug` (`--logLevel=1`) or `debug+trace` (`--logLevel=2`) one needs to build OMSimulator with debug configuration enabled. Refer to the [OMSimulator README on GitHub](#) for further instructions.

8.2.2 Examples

```
OMSimulator --timeout 180 example.lua
```

8.3 OMSimulatorLib

This library is the core of OMSimulator and provides a C interface that can easily be utilized to handle co-simulation scenarios.

8.3.1 RunFile

Simulates a single FMU or SSP model.

```
oms_status_enu_t oms_RunFile(const char* filename);
```

8.3.2 addBus

Adds a bus to a given component.

```
oms_status_enu_t oms_addBus(const char* cref);
```

8.3.3 addConnection

Adds a new connection between connectors *A* and *B*. The connectors need to be specified as fully qualified component references, e.g., "*model.system.component.signal*".

```
oms_status_enu_t oms_addConnection(const char* crefA, const char* crefB);
```

The two arguments *crefA* and *crefB* get swapped automatically if necessary.

8.3.4 addConnector

Adds a connector to a given component.

```
oms_status_enu_t oms_addConnector(const char* cref, oms_causality_enu_t causality,
↳ oms_signal_type_enu_t type);
```

8.3.5 addConnectorToBus

Adds a connector to a bus.

```
oms_status_enu_t oms_addConnectorToBus(const char* busCref, const char*
↳ connectorCref);
```

8.3.6 addConnectorToTLMBus

Adds a connector to a TLM bus.

```
oms_status_enu_t oms_addConnectorToTLMBus(const char* busCref, const char*
↳ connectorCref, const char *type);
```

8.3.7 addExternalModel

Adds an external model to a TLM system.

```
oms_status_enu_t oms_addExternalModel(const char* cref, const char* path, const_
↳char* startscript);
```

8.3.8 addSignalsToResults

Add all variables that match the given regex to the result file.

```
oms_status_enu_t oms_addSignalsToResults(const char* cref, const char* regex);
```

The second argument, i.e. regex, is considered as a regular expression (C++11). "." and "(.)" can be used to hit all variables.

8.3.9 addSubModel

Adds a component to a system.

```
oms_status_enu_t oms_addSubModel(const char* cref, const char* fmuPath);
```

8.3.10 addSystem

Adds a (sub-)system to a model or system.

```
oms_status_enu_t oms_addSystem(const char* cref, oms_system_enu_t type);
```

8.3.11 addTLMBus

Adds a TLM bus.

```
oms_status_enu_t oms_addTLMBus(const char* cref, oms_tlm_domain_t domain, const_
↳int dimensions, const oms_tlm_interpolation_t interpolation);
```

8.3.12 addTLMConnection

Connects two TLM connectors.

```
oms_status_enu_t oms_addTLMConnection(const char* crefA, const char* crefB, double_
↳delay, double alpha, double linearimpedance, double angularimpedance);
```

8.3.13 cancelSimulation_asynchronous

Cancels a running asynchronous simulation.

```
oms_status_enu_t oms_cancelSimulation_asynchronous(const char* cref);
```

8.3.14 compareSimulationResults

This function compares a given signal of two result files within absolute and relative tolerances.

```
int oms_compareSimulationResults(const char* filenameA, const char* filenameB,
↳const char* var, double relTol, double absTol);
```

The following table describes the input values:

Input	Type	Description
filenameA	String	Name of first result file to compare.
filenameB	String	Name of second result file to compare.
var	String	Name of signal to compare.
relTol	Number	Relative tolerance.
absTol	Number	Absolute tolerance.

The following table describes the return values:

Type	Description
Integer	1 if the signal is considered as equal, 0 otherwise

8.3.15 copySystem

Copies a system.

```
oms_status_enu_t oms_copySystem(const char* source, const char* target);
```

8.3.16 delete

Deletes a connector, component, system, or model object.

```
oms_status_enu_t oms_delete(const char* cref);
```

8.3.17 deleteConnection

Deletes the connection between connectors *crefA* and *crefB*.

```
oms_status_enu_t oms_deleteConnection(const char* crefA, const char* crefB);
```

The two arguments *crefA* and *crefB* get swapped automatically if necessary.

8.3.18 deleteConnectorFromBus

Deletes a connector from a given bus.

```
oms_status_enu_t oms_deleteConnectorFromBus(const char* busCref, const char*
↳connectorCref);
```

8.3.19 deleteConnectorFromTLMBus

Deletes a connector from a given TLM bus.

```
oms_status_enu_t oms_deleteConnectorFromTLMBus(const char* busCref, const char*  
↳connectorCref);
```

8.3.20 export

Exports a composite model to a SPP file.

```
oms_status_enu_t oms_export(const char* cref, const char* filename);
```

8.3.21 exportDependencyGraphs

Export the dependency graphs of a given model to dot files.

```
oms_status_enu_t oms_exportDependencyGraphs(const char* cref, const char*  
↳initialization, const char* simulation);
```

8.3.22 extractFMKind

Extracts the FMI kind of a given FMU from the file system.

```
oms_status_enu_t oms_extractFMKind(const char* filename, oms_fmi_kind_enu_t*  
↳kind);
```

8.3.23 faultInjection

Defines a new fault injection block.

```
oms_status_enu_t oms_faultInjection(const char* signal, oms_fault_type_enu_t  
↳faultType, double faultValue);
```

type	Description"
oms_fault_type_bias	$y = y.\$original + \text{faultValue}$
oms_fault_type_gain	$y = y.\$original * \text{faultValue}$
oms_fault_type_const	$y = \text{faultValue}$

8.3.24 freeMemory

Free the memory allocated by some other API. Pass the object for which memory is allocated.

```
void oms_freeMemory(void* obj);
```

8.3.25 getBoolean

Get boolean value of given signal.

```
oms_status_enu_t oms_getBoolean(const char* cref, bool* value);
```

8.3.26 getBus

Gets the bus object.

```
oms_status_enu_t oms_getBus(const char* cref, oms_busconnector_t** busConnector);
```

8.3.27 GetComponentType

Gets the type of the given component.

```
oms_status_enu_t oms_getComponentType(const char* cref, oms_component_enu_t* type);
```

8.3.28 getConnections

Get list of all connections from a given component.

```
oms_status_enu_t oms_getConnections(const char* cref, oms_connection_t***  
↪connections);
```

8.3.29 getConnector

Gets the connector object of the given connector cref.

```
oms_status_enu_t oms_getConnector(const char* cref, oms_connector_t** connector);
```

8.3.30 getElement

Get element information of a given component reference.

```
oms_status_enu_t oms_getElement(const char* cref, oms_element_t** element);
```

8.3.31 getElements

Get list of all sub-components of a given component reference.

```
oms_status_enu_t oms_getElements(const char* cref, oms_element_t*** elements);
```

8.3.32 getFMUInfo

Returns FMU specific information.

```
oms_status_enu_t oms_getFMUInfo(const char* cref, const oms_fm_u_info_t** fmuInfo);
```

8.3.33 getFixedStepSize

Gets the fixed step size. Can be used for the communication step size of co-simulation systems and also for the integrator step size in model exchange systems.

```
oms_status_enu_t oms_getFixedStepSize(const char* cref, double* stepSize);
```

8.3.34 getInteger

Get integer value of given signal.

```
oms_status_enu_t oms_getInteger(const char* cref, int* value);
```

8.3.35 getModelState

Gets the model state of the given model cref.

```
oms_status_enu_t oms_getModelState(const char* cref, oms_modelState_enu_t*  
↳modelState);
```

8.3.36 getReal

Get real value.

```
oms_status_enu_t oms_getReal(const char* cref, double* value);
```

8.3.37 getResultFile

Gets the result filename and buffer size of the given model cref.

```
oms_status_enu_t oms_getResultFile(const char* cref, char** filename, int*  
↳bufferSize);
```

8.3.38 getSignalFilter

Gets the signal filter of the given model cref.

```
oms_status_enu_t oms_getSignalFilter(const char* cref, char** regex);
```

8.3.39 getSolver

Gets the selected solver method of the given system.

```
oms_status_enu_t oms_getSolver(const char* cref, oms_solver_enu_t* solver);
```

8.3.40 getStartTime

Get the start time from the model.

```
oms_status_enu_t oms_getStartTime(const char* cref, double* startTime);
```

8.3.41 getStopTime

Get the stop time from the model.

```
oms_status_enu_t oms_getStopTime(const char* cref, double* stopTime);
```

8.3.42 getSubModelPath

Returns the path of a given component.

```
oms_status_enu_t oms_getSubModelPath(const char* cref, char** path);
```

8.3.43 getSystemType

Gets the type of the given system.

```
oms_status_enu_t oms_getSystemType(const char* cref, oms_system_enu_t* type);
```

8.3.44 getTLMBus

Gets the TLM bus objects of the given TLM bus cref.

```
oms_status_enu_t oms_getTLMBus(const char* cref, oms_tlmconnector_t**  
↪ tlmBusConnector);
```

8.3.45 getTLMVariableTypes

Gets the type of an TLM variable.

```
oms_status_enu_t oms_getTLMVariableTypes(oms_tlm_domain_t domain, const int_  
↪ dimensions, const oms_tlm_interpolation_t interpolation, char ***types, char_  
↪ ***descriptions);
```

8.3.46 getTolerance

Gets the tolerance of a given system or component.

```
oms_status_enu_t oms_getTolerance(const char* cref, double* absoluteTolerance,   
↪ double* relativeTolerance);
```

8.3.47 getVariableStepSize

Gets the step size parameters.

```
oms_status_enu_t oms_getVariableStepSize(const char* cref, double* initialStepSize,   
↪ double* minimumStepSize, double* maximumStepSize);
```

8.3.48 getVersion

Returns the library's version string.

```
const char* oms_getVersion();
```

8.3.49 importFile

Imports a composite model from a SSP file.

```
oms_status_enu_t oms_importFile(const char* filename, char** cref);
```

8.3.50 initialize

Initializes a composite model.

```
oms_status_enu_t oms_initialize(const char* cref);
```

8.3.51 instantiate

Instantiates a given composite model.

```
oms_status_enu_t oms_instantiate(const char* cref);
```

8.3.52 list

Lists the SSD representation of a given model, system, or component.

Memory is allocated for *contents*. The caller is responsible to free it using the C-API. The Lua and Python bindings take care of the memory and the caller doesn't need to call free.

```
oms_status_enu_t oms_list(const char* cref, char** contents);
```

8.3.53 listUnconnectedConnectors

Lists all unconnected connectors of a given system.

Memory is allocated for *contents*. The caller is responsible to free it using the C-API. The Lua and Python bindings take care of the memory and the caller doesn't need to call free.

```
oms_status_enu_t oms_listUnconnectedConnectors(const char* cref, char** contents);
```

8.3.54 loadSnapshot

Loads a snapshot to restore a previous model state. The model must be in virgin model state, which means it must not be instantiated.

```
oms_status_enu_t oms_loadSnapshot(const char* cref, const char* snapshot);
```

8.3.55 newModel

Creates a new and yet empty composite model.

```
oms_status_enu_t oms_newModel(const char* cref);
```

8.3.56 parseModelName

Parses the model name from a given SSD representation.

Memory is allocated for *ident*. The caller is responsible to free it using the C-API. The Lua and Python bindings take care of the memory and the caller doesn't need to call free.

```
oms_status_enu_t oms_parseModelName(const char* contents, char** cref);
```

8.3.57 removeSignalsFromResults

Removes all variables that match the given regex to the result file.

```
oms_status_enu_t oms_removeSignalsFromResults(const char* cref, const char* regex);
```

The second argument, i.e. regex, is considered as a regular expression (C++11). "." and "(.)" can be used to hit all variables.

8.3.58 rename

Renames a model, system, or component.

```
oms_status_enu_t oms_rename(const char* cref, const char* newCref);
```

8.3.59 reset

Reset the composite model after a simulation run.

The FMUs go into the same state as after instantiation.

```
oms_status_enu_t oms_reset(const char* cref);
```

8.3.60 setActivationRatio

Experimental feature for setting the activation ratio of FMUs for experimenting with multi-rate master algorithms.

```
oms_status_enu_t experimental_setActivationRatio(const char* cref, int k);
```

8.3.61 setBoolean

Sets the value of a given boolean signal.

```
oms_status_enu_t oms_setBoolean(const char* cref, bool value);
```

8.3.62 setBusGeometry

```
oms_status_enu_t oms_setBusGeometry(const char* bus, const ssd_connector_geometry_
↳t* geometry);
```

8.3.63 setCommandLineOption

Sets special flags.

```
oms_status_enu_t oms_setCommandLineOption(const char* cmd);
```

Available flags:

```
info:      Usage: OMSimulator [Options] [Lua script] [FMU] [SSP file]
Options:
  --addParametersToCSV=<arg>      Export parameters to .csv file (true,
↳[false])
  --clearAllOptions                Reset all flags to default values
  --deleteTempFiles=<bool>        Deletes temp files as soon as they are
↳no longer needed ([true], false)
  --emitEvents=<bool>             Specifies whether events should be
↳emitted or not ([true], false)
  --exportParametersInline=<arg>  Export ParameterBindings inline with .
↳ssd file,
  --fetchAllVars=<arg>            Workaround for certain FMUs that do not
↳update all internal dependencies automatically
  --help [-h]                     Displays the help text
  --ignoreInitialUnknowns=<bool>  Ignore the initial unknowns from the
↳modelDescription.xml (true, [false])
  --inputExtrapolation=<bool>     Enables input extrapolation using
↳derivative information (true, [false])
  --intervals=<int> [-i]          Specifies the number of communication
↳points (arg > 1)
  --logFile=<arg> [-l]            Specifies the logfile (stdout is used
↳if no log file is specified)
  --logLevel=<int>                0 default, 1 debug, 2 debug+trace
```

(continues on next page)

(continued from previous page)

<code>--maxEventIteration=<int></code>	Specifies the max. number of iterations.
<code>↔for</code> handling a single event	
<code>--maxLoopIteration=<int></code>	Specifies the max. number of iterations.
<code>↔for</code> solving algebraic loops between system-level components. Internal algebraic loops of components are not affected.	
<code>--mode=<arg> [-m]</code>	Forces a certain FMI mode iff the FMU
<code>↔provides</code> cs and me (cs, [me])	
<code>--numProcs=<int> [-n]</code>	Specifies the max. number of processors.
<code>↔to use</code> (0=auto, 1=default)	
<code>--progressBar=<bool></code>	Shows a progress bar for the simulation.
<code>↔progress</code> in the terminal (true, [false])	
<code>--realTime=<bool></code>	Experimental feature for (soft) real-
<code>↔time</code> co-simulation (true, [false])	
<code>--resultFile=<arg> [-r]</code>	Specifies the name of the output result.
<code>↔file</code>	
<code>--setInputDerivatives=<bool></code>	Deprecated; see ' <code>--inputExtrapolation</code> '
<code>--skipCSVHeader=<arg></code>	Skip exporting the scv delimiter in the
<code>↔header</code> (true, [false]),	
<code>--solver=<arg></code>	Specifies the integration method (euler,
<code>↔ [cvsode])</code>	
<code>--solverStats=<bool></code>	Adds solver stats to the result file, e.
<code>↔g.</code> step size; not supported for all solvers (true, [false])	
<code>--startTime=<double> [-s]</code>	Specifies the start time
<code>--stopTime=<double> [-t]</code>	Specifies the stop time
<code>--stripRoot=<bool></code>	Removes the root system prefix from all
<code>↔exported</code> signals (true, [false])	
<code>--suppressPath=<bool></code>	Supresses path information in info.
<code>↔messages</code> ; especially useful for testing (true, [false])	
<code>--tempDir=<arg></code>	Specifies the temp directory
<code>--timeout=<int></code>	Specifies the maximum allowed time in
<code>↔seconds</code> for running a simulation (0 disables)	
<code>--tolerance=<double></code>	Specifies the relative tolerance
<code>--version [-v]</code>	Displays version information
<code>--wallTime=<bool></code>	Add wall time information for to the
<code>↔result</code> file (true, [false])	
<code>--workingDir=<arg></code>	Specifies the working directory

8.3.64 setConnectionGeometry

```
oms_status_enu_t oms_setConnectionGeometry(const char* crefA, const char* crefB,
↔const ssd_connection_geometry_t* geometry);
```

8.3.65 setConnectorGeometry

Set geometry information to a given connector.

```
oms_status_enu_t oms_setConnectorGeometry(const char* cref, const ssd_connector_
↔geometry_t* geometry);
```

8.3.66 setElementGeometry

Set geometry information to a given component.

```
oms_status_enu_t oms_setElementGeometry(const char* cref, const ssd_element_  
↳geometry_t* geometry);
```

8.3.67 setFixedStepSize

Sets the fixed step size. Can be used for the communication step size of co-simulation systems and also for the integrator step size in model exchange systems.

```
oms_status_enu_t oms_setFixedStepSize(const char* cref, double stepSize);
```

8.3.68 setInteger

Sets the value of a given integer signal.

```
oms_status_enu_t oms_setInteger(const char* cref, int value);
```

8.3.69 setLogFile

Redirects logging output to file or std streams. The warning/error counters are reset.

filename="" to redirect to std streams and proper filename to redirect to file.

```
oms_status_enu_t oms_setLogFile(const char* filename);
```

8.3.70 setLoggingCallback

Sets a callback function for the logging system.

```
void oms_setLoggingCallback(void (*cb) (oms_message_type_enu_t type, const char*_  
↳message));
```

8.3.71 setLoggingInterval

Set the logging interval of the simulation.

```
oms_status_enu_t oms_setLoggingInterval(const char* cref, double loggingInterval);
```

8.3.72 setLoggingLevel

Enables/Disables debug logging (logDebug and logTrace).

0 default, 1 default+debug, 2 default+debug+trace

```
void oms_setLoggingLevel(int logLevel);
```

8.3.73 setMaxLogFileSize

Sets maximum log file size in MB. If the file exceeds this limit, the logging will continue on stdout.

```
void oms_setMaxLogFileSize(const unsigned long size);
```

8.3.74 setReal

Sets the value of a given real signal.

```
oms_status_enu_t oms_setReal(const char* cref, double value);
```

This function can be called in different model states:

- Before instantiation: *setReal* can be used to set start values or to define initial unknowns (e.g. parameters, states). The values are not immediately applied to the simulation unit, since it isn't actually instantiated.
- After instantiation and before initialization: Same as before instantiation, but the values are applied immediately to the simulation unit.
- After initialization: Can be used to force external inputs, which might cause discrete changes of continuous signals.

8.3.75 setRealInputDerivative

Sets the first order derivative of a real input signal.

This can only be used for CS-FMU real input signals.

```
oms_status_enu_t oms_setRealInputDerivative(const char* cref, double value);
```

8.3.76 setResultFile

Set the result file of the simulation.

```
oms_status_enu_t oms_setResultFile(const char* cref, const char* filename, int_
↳bufferSize);
```

The creation of a result file is omitted if the filename is an empty string.

8.3.77 setSignalFilter

```
oms_status_enu_t oms_setSignalFilter(const char* cref, const char* regex);
```

8.3.78 setSolver

Sets the solver method for the given system.

```
oms_status_enu_t oms_setSolver(const char* cref, oms_solver_enu_t solver);
```

8.3.79 setStartTime

Set the start time of the simulation.

```
oms_status_enu_t oms_setStartTime(const char* cref, double startTime);
```

8.3.80 setStopTime

Set the stop time of the simulation.

```
oms_status_enu_t oms_setStopTime(const char* cref, double stopTime);
```

8.3.81 setTLMBusGeometry

```
oms_status_enu_t oms_setTLMBusGeometry(const char* bus, const ssd_connector_
↳geometry_t* geometry);
```

8.3.82 setTLMConnectionParameters

Simulates a composite model in its own thread.

```
oms_status_enu_t oms_setTLMConnectionParameters(const char* crefA, const char*
↳crefB, const oms_tlm_connection_parameters_t* parameters);
```

8.3.83 setTLMPositionAndOrientation

Sets initial position and orientation for a TLM 3D interface.

```
oms_status_enu_t oms_setTLMPositionAndOrientation(cref, x1, x2, x3, A11, A12, A13,
↳A21, A22, A23, A31, A32, A33);
```

8.3.84 setTLMSocketData

Sets data for TLM socket communication.

```
oms_status_enu_t oms_setTLMSocketData(const char* cref, const char* address, int
↳managerPort, int monitorPort);
```

8.3.85 setTempDirectory

Set new temp directory.

```
oms_status_enu_t oms_setTempDirectory(const char* newTempDir);
```

8.3.86 setTolerance

Sets the tolerance for a given model or system.

```
oms_status_enu_t oms_setTolerance(const char* cref, double absoluteTolerance,
↪ double relativeTolerance);
```

Default values are $1e-4$ for both relative and absolute tolerances.

A tolerance specified for a model is automatically applied to its root system, i.e. both calls do exactly the same:

```
oms_setTolerance("model", absoluteTolerance, relativeTolerance);
oms_setTolerance("model.root", absoluteTolerance, relativeTolerance);
```

Component, e.g. FMUs, pick up the tolerances from there system. That means it is not possible to define different tolerances for FMUs in the same system right now.

In a strongly coupled system (*oms_system_sc*), the relative tolerance is used for CVODE and the absolute tolerance is used to solve algebraic loops.

In a weakly coupled system (*oms_system_wc*), both the relative and absolute tolerances are used for the adaptive step master algorithms and the absolute tolerance is used to solve algebraic loops.

8.3.87 setVariableStepSize

Sets the step size parameters for methods with stepsize control.

```
oms_status_enu_t oms_getVariableStepSize(const char* cref, double* initialStepSize,
↪ double* minimumStepSize, double* maximumStepSize);
```

8.3.88 setWorkingDirectory

Set a new working directory.

```
oms_status_enu_t oms_setWorkingDirectory(const char* newWorkingDir);
```

8.3.89 simulate

Simulates a composite model.

```
oms_status_enu_t oms_simulate(const char* cref);
```

8.3.90 simulate_asynchronous

Simulates a composite model in its own thread.

```
oms_status_enu_t oms_simulate_asynchronous(const char* cref, void (*cb)(const_
↪ char* cref, double time, oms_status_enu_t status));
```

8.3.91 simulate_realtime

Experimental feature for (soft) real-time simulation.

```
oms_status_enu_t experimental_simulate_realtime(const char* ident);
```

8.3.92 stepUntil

Simulates a composite model until a given time value.

```
oms_status_enu_t oms_stepUntil(const char* cref, double stopTime);
```

8.3.93 terminate

Terminates a given composite model.

```
oms_status_enu_t oms_terminate(const char* cref);
```

8.4 OMSimulatorLua

This is a shared library that provides a Lua interface for the OMSimulatorLib library.

```
oms_setTempDirectory("./temp/")
oms_newModel("model")
oms_addSystem("model.root", oms_system_sc)

-- instantiate FMUs
oms_addSubModel("model.root.system1", "FMUs/System1.fmu")
oms_addSubModel("model.root.system2", "FMUs/System2.fmu")

-- add connections
oms_addConnection("model.root.system1.y", "model.root.system2.u")
oms_addConnection("model.root.system2.y", "model.root.system1.u")

-- simulation settings
oms_setResultFile("model", "results.mat")
oms_setStopTime("model", 0.1)
oms_setFixedStepSize("model.root", 1e-4)

oms_instantiate("model")
oms_setReal("model.root.system1.x_start", 2.5)

oms_initialize("model")
oms_simulate("model")
oms_terminate("model")
oms_delete("model")
```

8.4.1 RunFile

Simulates a single FMU or SSP model.

```
# not available
```

8.4.2 addBus

Adds a bus to a given component.

```
status = oms_addBus(cref)
```

8.4.3 addConnection

Adds a new connection between connectors *A* and *B*. The connectors need to be specified as fully qualified component references, e.g., "*model.system.component.signal*".

```
status = oms_addConnection(crefA, crefB)
```

The two arguments *crefA* and *crefB* get swapped automatically if necessary.

8.4.4 addConnector

Adds a connector to a given component.

```
status = oms_addConnector(cref, causality, type)
```

The second argument "*causality*", should be any of the following,

```
oms_causality_input
oms_causality_output
oms_causality_parameter
oms_causality_bidir
oms_causality_undefined
```

The third argument "*type*", should be any of the following,

```
oms_signal_type_real
oms_signal_type_integer
oms_signal_type_boolean
oms_signal_type_string
oms_signal_type_enum
oms_signal_type_bus
```

8.4.5 addConnectorToBus

Adds a connector to a bus.

```
status = oms_addConnectorToBus(busCref, connectorCref)
```

8.4.6 addConnectorToTLMBus

Adds a connector to a TLM bus.

```
status = oms_addConnectorToTLMBus(busCref, connectorCref, type)
```

8.4.7 addExternalModel

Adds an external model to a TLM system.

```
status = oms_addExternalModel(cref, path, startscript)
```

8.4.8 addSignalsToResults

Add all variables that match the given regex to the result file.

```
status = oms_addSignalsToResults(cref, regex)
```

The second argument, i.e. regex, is considered as a regular expression (C++11). `".*"` and `"(.)*"` can be used to hit all variables.

8.4.9 addSubModel

Adds a component to a system.

```
status = oms_addSubModel(cref, fmuPath)
```

8.4.10 addSystem

Adds a (sub-)system to a model or system.

```
status = oms_addSystem(cref, type)
```

8.4.11 addTLMBus

Adds a TLM bus.

```
status = oms_addTLMBus(cref, domain, dimensions, interpolation)
```

The second argument `"domain"`, should be any of the following,

```
oms_tlm_domain_input
oms_tlm_domain_output
oms_tlm_domain_mechanical
oms_tlm_domain_rotational
oms_tlm_domain_hydraulic
oms_tlm_domain_electric
```

The fourth argument `"interpolation"`, should be any of the following,

```
oms_tlm_no_interpolation
oms_tlm_coarse_grained
oms_tlm_fine_grained
```

8.4.12 addTLMConnection

Connects two TLM connectors.

```
status = oms_addTLMConnection(crefA, crefB, delay, alpha, linearimpedance, ↵
↵angularimpedance)
```

8.4.13 cancelSimulation_asynchronous

Cancels a running asynchronous simulation.

```
# not available
```

8.4.14 compareSimulationResults

This function compares a given signal of two result files within absolute and relative tolerances.

```
oms_compareSimulationResults(filenameA, filenameB, var, relTol, absTol)
```

The following table describes the input values:

Input	Type	Description
filenameA	String	Name of first result file to compare.
filenameB	String	Name of second result file to compare.
var	String	Name of signal to compare.
relTol	Number	Relative tolerance.
absTol	Number	Absolute tolerance.

The following table describes the return values:

Type	Description
Integer	1 if the signal is considered as equal, 0 otherwise

8.4.15 copySystem

Copies a system.

```
status = oms_copySystem(source, target)
```

8.4.16 delete

Deletes a connector, component, system, or model object.

```
status = oms_delete(cref)
```

8.4.17 deleteConnection

Deletes the connection between connectors *crefA* and *crefB*.

```
status = oms_deleteConnection(crefA, crefB)
```

The two arguments *crefA* and *crefB* get swapped automatically if necessary.

8.4.18 deleteConnectorFromBus

Deletes a connector from a given bus.

```
status = oms_deleteConnectorFromBus(busCref, connectorCref)
```

8.4.19 deleteConnectorFromTLMBus

Deletes a connector from a given TLM bus.

```
status = oms_deleteConnectorFromTLMBus(busCref, connectorCref)
```

8.4.20 export

Exports a composite model to a SPP file.

```
status = oms_export(cref, filename)
```

8.4.21 exportDependencyGraphs

Export the dependency graphs of a given model to dot files.

```
status = oms_exportDependencyGraphs(cref, initialization, simulation)
```

8.4.22 extractFMKind

Extracts the FMI kind of a given FMU from the file system.

```
# not available
```

8.4.23 faultInjection

Defines a new fault injection block.

```
status = oms_faultInjection(cref, type, value)
```

type	Description"
oms_fault_type_bias	$y = y.\$original + \text{faultValue}$
oms_fault_type_gain	$y = y.\$original * \text{faultValue}$
oms_fault_type_const	$y = \text{faultValue}$

8.4.24 freeMemory

Free the memory allocated by some other API. Pass the object for which memory is allocated.

This function is neither needed nor available from the Lua interface.

8.4.25 getBoolean

Get boolean value of given signal.

```
value, status = oms_getBoolean(cref)
```

8.4.26 getBus

Gets the bus object.

```
# not available
```

8.4.27 getComponentType

Gets the type of the given component.

```
# not available
```

8.4.28 getConnections

Get list of all connections from a given component.

```
# not available
```

8.4.29 getConnector

Gets the connector object of the given connector cref.

```
# not available
```

8.4.30 getElement

Get element information of a given component reference.

```
# not available
```

8.4.31 getElements

Get list of all sub-components of a given component reference.

```
# not available
```

8.4.32 getFMUInfo

Returns FMU specific information.

```
# not available
```

8.4.33 getFixedStepSize

Gets the fixed step size. Can be used for the communication step size of co-simulation systems and also for the integrator step size in model exchange systems.

```
stepSize, status = oms_setFixedStepSize(cref)
```

8.4.34 getInteger

Get integer value of given signal.

```
value, status = oms_getInteger(cref)
```

8.4.35 getModelState

Gets the model state of the given model cref.

```
modelState, status = oms_getModelState(cref)
```

8.4.36 getReal

Get real value.

```
value, status = oms_getReal(cref)
```

8.4.37 getResultFile

Gets the result filename and buffer size of the given model cref.

```
# not available
```

8.4.38 getSignalFilter

Gets the signal filter of the given model cref.

```
# not available
```

8.4.39 getSolver

Gets the selected solver method of the given system.

```
solver, status = oms_getSolver(cref)
```

8.4.40 getStartTime

Get the start time from the model.

```
startTime, status = oms_getStartTime(cref)
```

8.4.41 getStopTime

Get the stop time from the model.

```
stopTime, status = oms_getStopTime(cref)
```

8.4.42 getSubModelPath

Returns the path of a given component.

```
# not available
```

8.4.43 getSystemType

Gets the type of the given system.

```
type, status = oms_getSystemType(cref)
```

8.4.44 getTLMBus

Gets the TLM bus objects of the given TLM bus cref.

```
# not available
```

8.4.45 getTLMVariableTypes

Gets the type of an TLM variable.

```
# not available
```

8.4.46 getTolerance

Gets the tolerance of a given system or component.

```
absoluteTolerance, relativeTolerance, status = oms_getTolerance(cref)
```

8.4.47 getVariableStepSize

Gets the step size parameters.

```
initialStepSize, minimumStepSize, maximumStepSize, status = oms_  
↳getVariableStepSize(cref)
```

8.4.48 getVersion

Returns the library's version string.

```
version = oms_getVersion()
```

8.4.49 importFile

Imports a composite model from a SSP file.

```
cref, status = oms_importFile(filename)
```

8.4.50 initialize

Initializes a composite model.

```
status = oms_initialize(cref)
```

8.4.51 instantiate

Instantiates a given composite model.

```
status = oms_instantiate(cref)
```

8.4.52 list

Lists the SSD representation of a given model, system, or component.

Memory is allocated for *contents*. The caller is responsible to free it using the C-API. The Lua and Python bindings take care of the memory and the caller doesn't need to call free.

```
contents, status = oms_list(cref)
```

8.4.53 listUnconnectedConnectors

Lists all unconnected connectors of a given system.

Memory is allocated for *contents*. The caller is responsible to free it using the C-API. The Lua and Python bindings take care of the memory and the caller doesn't need to call free.

```
contents, status = oms_listUnconnectedConnectors(cref)
```

8.4.54 loadSnapshot

Loads a snapshot to restore a previous model state. The model must be in virgin model state, which means it must not be instantiated.

```
status = oms_loadSnapshot(cref, snapshot)
```

8.4.55 newModel

Creates a new and yet empty composite model.

```
status = oms_newModel(cref)
```

8.4.56 parseModelName

Parses the model name from a given SSD representation.

Memory is allocated for *ident*. The caller is responsible to free it using the C-API. The Lua and Python bindings take care of the memory and the caller doesn't need to call free.

```
ident, status = oms_parseModelName(contents)
```

8.4.57 removeSignalsFromResults

Removes all variables that match the given regex to the result file.

```
status = oms_removeSignalsFromResults(cref, regex)
```

The second argument, i.e. regex, is considered as a regular expression (C++11). "." and "(.)" can be used to hit all variables.

8.4.58 rename

Renames a model, system, or component.

```
status = oms_rename(cref, newCref)
```

8.4.59 reset

Reset the composite model after a simulation run.

The FMUs go into the same state as after instantiation.

```
status = oms_reset(cref)
```

8.4.60 setActivationRatio

Experimental feature for setting the activation ratio of FMUs for experimenting with multi-rate master algorithms.

```
status = experimental_setActivationRatio(cref, k)
```

8.4.61 setBoolean

Sets the value of a given boolean signal.

```
status = oms_setBoolean(cref, value)
```

8.4.62 setBusGeometry

```
# not available
```

8.4.63 setCommandLineOption

Sets special flags.

```
status = oms_setCommandLineOption(cmd)
```

Available flags:

```
info:      Usage: OMSimulator [Options] [Lua script] [FMU] [SSP file]
           Options:
             --addParametersToCSV=<arg>      Export parameters to .csv file (true, ↵
↵[false])
             --clearAllOptions                Reset all flags to default values
             --deleteTempFiles=<bool>        Deletes temp files as soon as they are ↵
↵no longer needed ([true], false)
             --emitEvents=<bool>             Specifies whether events should be ↵
↵emitted or not ([true], false)
             --exportParametersInline=<arg>   Export ParameterBindings inline with ↵
↵.ssd file,
             --fetchAllVars=<arg>            Workaround for certain FMUs that do not ↵
↵update all internal dependencies automatically
             --help [-h]                     Displays the help text
             --ignoreInitialUnknowns=<bool> Ignore the initial unknowns from the ↵
↵modelDescription.xml (true, [false])
             --inputExtrapolation=<bool>     Enables input extrapolation using ↵
↵derivative information (true, [false])
             --intervals=<int> [-i]          Specifies the number of communication ↵
↵points (arg > 1)
             --logFile=<arg> [-l]            Specifies the logfile (stdout is used ↵
↵if no log file is specified)
             --logLevel=<int>                0 default, 1 debug, 2 debug+trace
             --maxEventIteration=<int>       Specifies the max. number of iterations ↵
↵for handling a single event
```

(continues on next page)

(continued from previous page)

<code>--maxLoopIteration=<int></code>	Specifies the max. number of iterations.
<code>↔for</code> solving algebraic loops between system-level components. Internal algebraic loops of components are not affected.	
<code>--mode=<arg> [-m]</code>	Forces a certain FMI mode iff the FMU
<code>↔provides</code> cs and me (cs, [me])	
<code>--numProcs=<int> [-n]</code>	Specifies the max. number of processors.
<code>↔to use</code> (0=auto, 1=default)	
<code>--progressBar=<bool></code>	Shows a progress bar for the simulation.
<code>↔progress</code> in the terminal (true, [false])	
<code>--realTime=<bool></code>	Experimental feature for (soft) real-
<code>↔time</code> co-simulation (true, [false])	
<code>--resultFile=<arg> [-r]</code>	Specifies the name of the output result.
<code>↔file</code>	
<code>--setInputDerivatives=<bool></code>	Deprecated; see ' <code>--inputExtrapolation</code> '
<code>--skipCSVHeader=<arg></code>	Skip exporting the scv delimiter in the
<code>↔header</code> (true, [false]),	
<code>--solver=<arg></code>	Specifies the integration method (euler,
<code>↔ [cvsode])</code>	
<code>--solverStats=<bool></code>	Adds solver stats to the result file, e.
<code>↔g.</code> step size; not supported for all solvers (true, [false])	
<code>--startTime=<double> [-s]</code>	Specifies the start time
<code>--stopTime=<double> [-t]</code>	Specifies the stop time
<code>--stripRoot=<bool></code>	Removes the root system prefix from all
<code>↔exported</code> signals (true, [false])	
<code>--suppressPath=<bool></code>	Supresses path information in info
<code>↔messages</code> ; especially useful for testing (true, [false])	
<code>--tempDir=<arg></code>	Specifies the temp directory
<code>--timeout=<int></code>	Specifies the maximum allowed time in
<code>↔seconds</code> for running a simulation (0 disables)	
<code>--tolerance=<double></code>	Specifies the relative tolerance
<code>--version [-v]</code>	Displays version information
<code>--wallTime=<bool></code>	Add wall time information for to the
<code>↔result</code> file (true, [false])	
<code>--workingDir=<arg></code>	Specifies the working directory

8.4.64 setConnectionGeometry

```
# not available
```

8.4.65 setConnectorGeometry

Set geometry information to a given connector.

```
# not available
```

8.4.66 setElementGeometry

Set geometry information to a given component.

```
# not available
```

8.4.67 setFixedStepSize

Sets the fixed step size. Can be used for the communication step size of co-simulation systems and also for the integrator step size in model exchange systems.

```
status = oms_setFixedStepSize(cref, stepSize)
```

8.4.68 setInteger

Sets the value of a given integer signal.

```
status = oms_setInteger(cref, value)
```

8.4.69 setLogFile

Redirects logging output to file or std streams. The warning/error counters are reset.

filename="" to redirect to std streams and proper filename to redirect to file.

```
status = oms_setLogFile(filename)
```

8.4.70 setLoggingCallback

Sets a callback function for the logging system.

```
# not available
```

8.4.71 setLoggingInterval

Set the logging interval of the simulation.

```
status = oms_setLoggingInterval(cref, loggingInterval)
```

8.4.72 setLoggingLevel

Enables/Disables debug logging (logDebug and logTrace).

0 default, 1 default+debug, 2 default+debug+trace

```
oms_setLoggingLevel(logLevel)
```

8.4.73 setMaxLogFileSize

Sets maximum log file size in MB. If the file exceeds this limit, the logging will continue on stdout.

```
oms_setMaxLogFileSize(size)
```

8.4.74 setReal

Sets the value of a given real signal.

```
status = oms_setReal(cref, value)
```

This function can be called in different model states:

- Before instantiation: *setReal* can be used to set start values or to define initial unknowns (e.g. parameters, states). The values are not immediately applied to the simulation unit, since it isn't actually instantiated.
- After instantiation and before initialization: Same as before instantiation, but the values are applied immediately to the simulation unit.
- After initialization: Can be used to force external inputs, which might cause discrete changes of continuous signals.

8.4.75 setRealInputDerivative

Sets the first order derivative of a real input signal.

This can only be used for CS-FMU real input signals.

```
status = oms_setRealInputDerivative(cref, value)
```

8.4.76 setResultFile

Set the result file of the simulation.

```
status = oms_setResultFile(cref, filename)
status = oms_setResultFile(cref, filename, bufferSize)
```

The creation of a result file is omitted if the filename is an empty string.

8.4.77 setSignalFilter

```
status = oms_setSignalFilter(cref, regex)
```

8.4.78 setSolver

Sets the solver method for the given system.

```
status = oms_setSolver(cref, solver)
```

solver	Type	Description
oms_solver_sc_explicit_euler	sc-system	Explicit euler with fixed step size
oms_solver_sc_cvode	sc-system	CVODE with adaptive stepsize
oms_solver_wc_ma	wc-system	default master algorithm with fixed step size
oms_solver_wc_mav	wc-system	master algorithm with adaptive stepsize
oms_solver_wc_mav2	wc-system	master algorithm with adaptive stepsize (double-step)

8.4.79 setStartTime

Set the start time of the simulation.

```
status = oms_setStartTime(cref, startTime)
```

8.4.80 setStopTime

Set the stop time of the simulation.

```
status = oms_setStopTime(cref, stopTime)
```

8.4.81 setTLMBusGeometry

```
# not available
```

8.4.82 setTLMConnectionParameters

Simulates a composite model in its own thread.

```
# not available
```

8.4.83 setTLMPositionAndOrientation

Sets initial position and orientation for a TLM 3D interface.

```
status = oms_setTLMPositionAndOrientation(cref, x1, x2, x3, A11, A12, A13, A21, ↵  
↵A22, A23, A31, A32, A33)
```

8.4.84 setTLMSocketData

Sets data for TLM socket communication.

```
status = oms_setTLMSocketData(cref, address, managerPort, monitorPort)
```

8.4.85 setTempDirectory

Set new temp directory.

```
status = oms_setTempDirectory(newTempDir)
```

8.4.86 setTolerance

Sets the tolerance for a given model or system.

```
status = oms_setTolerance(const char* cref, double tolerance)  
status = oms_setTolerance(const char* cref, double absoluteTolerance, double ↵  
↵relativeTolerance)
```

Default values are $1e-4$ for both relative and absolute tolerances.

A tolerance specified for a model is automatically applied to its root system, i.e. both calls do exactly the same:

```
oms_setTolerance("model", absoluteTolerance, relativeTolerance);
oms_setTolerance("model.root", absoluteTolerance, relativeTolerance);
```

Component, e.g. FMUs, pick up the tolerances from there system. That means it is not possible to define different tolerances for FMUs in the same system right now.

In a strongly coupled system (*oms_system_sc*), the relative tolerance is used for CVODE and the absolute tolerance is used to solve algebraic loops.

In a weakly coupled system (*oms_system_wc*), both the relative and absolute tolerances are used for the adaptive step master algorithms and the absolute tolerance is used to solve algebraic loops.

8.4.87 setVariableStepSize

Sets the step size parameters for methods with stepsize control.

```
status = oms_getVariableStepSize(cref, initialStepSize, minimumStepSize, ↵
↵maximumStepSize)
```

8.4.88 setWorkingDirectory

Set a new working directory.

```
status = oms_setWorkingDirectory(newWorkingDir)
```

8.4.89 simulate

Simulates a composite model.

```
status = oms_simulate(cref)
```

8.4.90 simulate_asynchronous

Simulates a composite model in its own thread.

```
# not available
```

8.4.91 simulate_realtime

Experimental feature for (soft) real-time simulation.

```
status = experimental_simulate_realtime(ident)
```

8.4.92 stepUntil

Simulates a composite model until a given time value.

```
status = oms_stepUntil(cref, stopTime)
```

8.4.93 terminate

Terminates a given composite model.

```
status = oms_terminate(cref)
```

8.5 OMSimulatorPython

This is a shared library that provides a Python interface for the OMSimulatorLib library.

```
from OMSimulator import OMSimulator

oms = OMSimulator()
oms.setTempDirectory("./temp/")
oms.newModel("model")
oms.addSystem("model.root", oms.system_sc)

# instantiate FMUs
oms.addSubModel("model.root.system1", "FMUs/System1.fmu")
oms.addSubModel("model.root.system2", "FMUs/System2.fmu")

# add connections
oms.addConnection("model.root.system1.y", "model.root.system2.u")
oms.addConnection("model.root.system2.y", "model.root.system1.u")

# simulation settings
oms.setResultFile("model", "results.mat")
oms.setStopTime("model", 0.1)
oms.setFixedStepSize("model.root", 1e-4)

oms.instantiate("model")
oms.setReal("model.root.system1.x_start", 2.5)

oms.initialize("model")
oms.simulate("model")
oms.terminate("model")
oms.delete("model")
```

8.5.1 RunFile

Simulates a single FMU or SSP model.

```
# not available
```

8.5.2 addBus

Adds a bus to a given component.

```
status = oms.addBus(cref)
```

8.5.3 addConnection

Adds a new connection between connectors *A* and *B*. The connectors need to be specified as fully qualified component references, e.g., *"model.system.component.signal"*.

```
status = oms.addConnection(crefA, crefB)
```

The two arguments *crefA* and *crefB* get swapped automatically if necessary.

8.5.4 addConnector

Adds a connector to a given component.

```
status = oms.addConnector(cref, causality, type)
```

The second argument *"causality"*, should be *any* of the following,

```
oms.input
oms.output
oms.parameter
oms.bidir
oms.undefined
```

The third argument *"type"*, should be *any* of the following,

```
oms.signal_type_real
oms.signal_type_integer
oms.signal_type_boolean
oms.signal_type_string
oms.signal_type_enum
oms.signal_type_bus
```

8.5.5 addConnectorToBus

Adds a connector to a bus.

```
status = oms.addConnectorToBus(busCref, connectorCref)
```

8.5.6 addConnectorToTLMBus

Adds a connector to a TLM bus.

```
status = oms.addConnectorToTLMBus(busCref, connectorCref, type)
```

8.5.7 addExternalModel

Adds an external model to a TLM system.

```
status = oms.addExternalModel(cref, path, startscript)
```

8.5.8 addSignalsToResults

Add all variables that match the given regex to the result file.

```
status = oms.addSignalsToResults(cref, regex)
```

The second argument, i.e. `regex`, is considered as a regular expression (C++11). `".*"` and `"(.)*"` can be used to hit all variables.

8.5.9 addSubModel

Adds a component to a system.

```
status = oms.addSubModel(cref, fmuPath)
```

8.5.10 addSystem

Adds a (sub-)system to a model or system.

```
status = oms.addSystem(cref, type)
```

8.5.11 addTLMBus

Adds a TLM bus.

```
status = oms.addTLMBus(cref, domain, dimensions, interpolation)
```

The second argument `"domain"`, should be any of the following,

```
oms.tlm_domain_input
oms.tlm_domain_output
oms.tlm_domain_mechanical
oms.tlm_domain_rotational
oms.tlm_domain_hydraulic
oms.tlm_domain_electric
```

The fourth argument `"interpolation"`, should be any of the following,

```
oms.default
oms.coarsegrained
oms.finegrained
```

8.5.12 addTLMConnection

Connects two TLM connectors.

```
status = oms.addTLMConnection(crefA, crefB, delay, alpha, linearimpedance, ↵
↵angularimpedance)
```

8.5.13 cancelSimulation_asynchronous

Cancels a running asynchronous simulation.

```
# not available
```

8.5.14 compareSimulationResults

This function compares a given signal of two result files within absolute and relative tolerances.

```
oms.compareSimulationResults(filenameA, filenameB, var, relTol, absTol)
```

The following table describes the input values:

Input	Type	Description
filenameA	String	Name of first result file to compare.
filenameB	String	Name of second result file to compare.
var	String	Name of signal to compare.
relTol	Number	Relative tolerance.
absTol	Number	Absolute tolerance.

The following table describes the return values:

Type	Description
Integer	1 if the signal is considered as equal, 0 otherwise

8.5.15 copySystem

Copies a system.

```
status = oms.copySystem(source, target)
```

8.5.16 delete

Deletes a connector, component, system, or model object.

```
status = oms.delete(cref)
```

8.5.17 deleteConnection

Deletes the connection between connectors *crefA* and *crefB*.

```
status = oms.deleteConnection(crefA, crefB)
```

The two arguments *crefA* and *crefB* get swapped automatically if necessary.

8.5.18 deleteConnectorFromBus

Deletes a connector from a given bus.

```
status = oms.deleteConnectorFromBus(busCref, connectorCref)
```

8.5.19 deleteConnectorFromTLMBus

Deletes a connector from a given TLM bus.

```
status = oms.deleteConnectorFromTLMBus(busCref, connectorCref)
```

8.5.20 export

Exports a composite model to a SPP file.

```
status = oms.export(cref, filename)
```

8.5.21 exportDependencyGraphs

Export the dependency graphs of a given model to dot files.

```
status = oms.exportDependencyGraphs(cref, initialization, simulation)
```

8.5.22 extractFMKind

Extracts the FMI kind of a given FMU from the file system.

```
# not available
```

8.5.23 faultInjection

Defines a new fault injection block.

```
status = oms.faultInjection(cref, type, value)
```

type	Description"
oms_fault_type_bias	$y = y.\$original + \text{faultValue}$
oms_fault_type_gain	$y = y.\$original * \text{faultValue}$
oms_fault_type_const	$y = \text{faultValue}$

8.5.24 freeMemory

Free the memory allocated by some other API. Pass the object for which memory is allocated.

```
oms.freeMemory(obj)
```

8.5.25 getBoolean

Get boolean value of given signal.

```
value, status = oms.getBoolean(cref)
```

8.5.26 getBus

Gets the bus object.

```
# not available
```

8.5.27 GetComponentType

Gets the type of the given component.

```
# not available
```

8.5.28 getConnections

Get list of all connections from a given component.

```
# not available
```

8.5.29 getConnector

Gets the connector object of the given connector cref.

```
# not available
```

8.5.30 getElement

Get element information of a given component reference.

```
# not available
```

8.5.31 getElements

Get list of all sub-components of a given component reference.

```
# not available
```

8.5.32 getFMUInfo

Returns FMU specific information.

```
# not available
```

8.5.33 getFixedStepSize

Gets the fixed step size. Can be used for the communication step size of co-simulation systems and also for the integrator step size in model exchange systems.

```
stepSize, status = oms.getFixedStepSize(cref)
```

8.5.34 getInteger

Get integer value of given signal.

```
value, status = oms.getInteger(cref)
```

8.5.35 getModelState

Gets the model state of the given model cref.

```
# not available
```

8.5.36 getReal

Get real value.

```
value, status = oms.getReal(cref)
```

8.5.37 getResultFile

Gets the result filename and buffer size of the given model cref.

```
# not available
```

8.5.38 getSignalFilter

Gets the signal filter of the given model cref.

```
# not available
```

8.5.39 getSolver

Gets the selected solver method of the given system.

```
solver, status = oms.getSolver(cref)
```

8.5.40 getStartTime

Get the start time from the model.

```
startTime, status = oms.getStartTime(cref)
```

8.5.41 getStopTime

Get the stop time from the model.

```
stopTime, status = oms.getStopTime(cref)
```

8.5.42 getSubModelPath

Returns the path of a given component.

```
path, status = oms.getSubModelPath(cref)
```

8.5.43 getSystemType

Gets the type of the given system.

```
type, status = oms.getSystemType(cref)
```

8.5.44 getTLMBus

Gets the TLM bus objects of the given TLM bus cref.

```
# not available
```

8.5.45 getTLMVariableTypes

Gets the type of an TLM variable.

```
# not available
```

8.5.46 getTolerance

Gets the tolerance of a given system or component.

```
absoluteTolerance, relativeTolerance, status = oms.getTolerance(cref)
```

8.5.47 getVariableStepSize

Gets the step size parameters.

```
initialStepSize, minimumStepSize, maximumStepSize, status = oms.  
↔getVariableStepSize(cref)
```

8.5.48 getVersion

Returns the library's version string.

```
oms = OMSimulator()  
oms.getVersion()
```

8.5.49 importFile

Imports a composite model from a SSP file.

```
cref, status = oms.importFile(filename)
```

8.5.50 initialize

Initializes a composite model.

```
status = oms.initialize(cref)
```

8.5.51 instantiate

Instantiates a given composite model.

```
status = oms.instantiate(cref)
```

8.5.52 list

Lists the SSD representation of a given model, system, or component.

Memory is allocated for *contents*. The caller is responsible to free it using the C-API. The Lua and Python bindings take care of the memory and the caller doesn't need to call free.

```
contents, status = oms.list(cref)
```

8.5.53 listUnconnectedConnectors

Lists all unconnected connectors of a given system.

Memory is allocated for *contents*. The caller is responsible to free it using the C-API. The Lua and Python bindings take care of the memory and the caller doesn't need to call free.

```
contents, status = oms.listUnconnectedConnectors(cref)
```

8.5.54 loadSnapshot

Loads a snapshot to restore a previous model state. The model must be in virgin model state, which means it must not be instantiated.

```
# not available
```

8.5.55 newModel

Creates a new and yet empty composite model.

```
status = oms.newModel(cref)
```

8.5.56 parseModelName

Parses the model name from a given SSD representation.

Memory is allocated for *ident*. The caller is responsible to free it using the C-API. The Lua and Python bindings take care of the memory and the caller doesn't need to call free.

```
ident, status = oms.parseModelName(contents)
```

8.5.57 removeSignalsFromResults

Removes all variables that match the given regex to the result file.

```
status = oms.removeSignalsFromResults(cref, regex)
```

The second argument, i.e. regex, is considered as a regular expression (C++11). `".*"` and `"(.)*"` can be used to hit all variables.

8.5.58 rename

Renames a model, system, or component.

```
status = oms.rename(cref, newCref)
```

8.5.59 reset

Reset the composite model after a simulation run.

The FMUs go into the same state as after instantiation.

```
status = oms.reset(cref)
```

8.5.60 setActivationRatio

Experimental feature for setting the activation ratio of FMUs for experimenting with multi-rate master algorithms.

```
# not yet available
```

8.5.61 setBoolean

Sets the value of a given boolean signal.

```
status = oms.setBoolean(cref, value)
```

8.5.62 setBusGeometry

```
# not available
```

8.5.63 setCommandLineOption

Sets special flags.

```
status = oms.setCommandLineOption(cmd)
```

Available flags:

```
info:      Usage: OMSimulator [Options] [Lua script] [FMU] [SSP file]
           Options:
             --addParametersToCSV=<arg>      Export parameters to .csv file (true, ↵
↵[false])
             --clearAllOptions                Reset all flags to default values
             --deleteTempFiles=<bool>        Deletes temp files as soon as they are ↵
↵no longer needed ([true], false)
             --emitEvents=<bool>             Specifies whether events should be ↵
↵emitted or not ([true], false)
             --exportParametersInline=<arg>   Export ParameterBindings inline with . ↵
↵ssd file,
             --fetchAllVars=<arg>            Workaround for certain FMUs that do not ↵
↵update all internal dependencies automatically
             --help [-h]                     Displays the help text
             --ignoreInitialUnknowns=<bool>  Ignore the initial unknowns from the ↵
↵modelDescription.xml (true, [false])
             --inputExtrapolation=<bool>     Enables input extrapolation using ↵
↵derivative information (true, [false])
             --intervals=<int> [-i]          Specifies the number of communication ↵
↵points (arg > 1)
             --logFile=<arg> [-l]            Specifies the logfile (stdout is used ↵
↵if no log file is specified)
             --logLevel=<int>                0 default, 1 debug, 2 debug+trace
             --maxEventIteration=<int>       Specifies the max. number of iterations ↵
↵for handling a single event
```

(continues on next page)

(continued from previous page)

<code>--maxLoopIteration=<int></code>	Specifies the max. number of iterations.
<code>↔for</code> solving algebraic loops between system-level components. Internal algebraic loops of components are not affected.	
<code>--mode=<arg> [-m]</code>	Forces a certain FMI mode iff the FMU
<code>↔provides</code> cs and me (cs, [me])	
<code>--numProcs=<int> [-n]</code>	Specifies the max. number of processors.
<code>↔to use</code> (0=auto, 1=default)	
<code>--progressBar=<bool></code>	Shows a progress bar for the simulation.
<code>↔progress</code> in the terminal (true, [false])	
<code>--realTime=<bool></code>	Experimental feature for (soft) real-
<code>↔time</code> co-simulation (true, [false])	
<code>--resultFile=<arg> [-r]</code>	Specifies the name of the output result.
<code>↔file</code>	
<code>--setInputDerivatives=<bool></code>	Deprecated; see ' <code>--inputExtrapolation</code> '
<code>--skipCSVHeader=<arg></code>	Skip exporting the scv delimiter in the
<code>↔header</code> (true, [false]),	
<code>--solver=<arg></code>	Specifies the integration method (euler,
<code>↔ [cvsode])</code>	
<code>--solverStats=<bool></code>	Adds solver stats to the result file, e.
<code>↔g.</code> step size; not supported for all solvers (true, [false])	
<code>--startTime=<double> [-s]</code>	Specifies the start time
<code>--stopTime=<double> [-t]</code>	Specifies the stop time
<code>--stripRoot=<bool></code>	Removes the root system prefix from all
<code>↔exported</code> signals (true, [false])	
<code>--suppressPath=<bool></code>	Supresses path information in info
<code>↔messages</code> ; especially useful for testing (true, [false])	
<code>--tempDir=<arg></code>	Specifies the temp directory
<code>--timeout=<int></code>	Specifies the maximum allowed time in
<code>↔seconds</code> for running a simulation (0 disables)	
<code>--tolerance=<double></code>	Specifies the relative tolerance
<code>--version [-v]</code>	Displays version information
<code>--wallTime=<bool></code>	Add wall time information for to the
<code>↔result</code> file (true, [false])	
<code>--workingDir=<arg></code>	Specifies the working directory

8.5.64 setConnectionGeometry

```
# not available
```

8.5.65 setConnectorGeometry

Set geometry information to a given connector.

```
# not available
```

8.5.66 setElementGeometry

Set geometry information to a given component.

```
# not available
```

8.5.67 setFixedStepSize

Sets the fixed step size. Can be used for the communication step size of co-simulation systems and also for the integrator step size in model exchange systems.

```
status = oms.setFixedStepSize(cref, stepSize)
```

8.5.68 setInteger

Sets the value of a given integer signal.

```
status = oms.setInteger(cref, value)
```

8.5.69 setLogFile

Redirects logging output to file or std streams. The warning/error counters are reset.

filename="" to redirect to std streams and proper filename to redirect to file.

```
status = oms.setLogFile(filename)
```

8.5.70 setLoggingCallback

Sets a callback function for the logging system.

```
# not available
```

8.5.71 setLoggingInterval

Set the logging interval of the simulation.

```
status = oms.setLoggingInterval(cref, loggingInterval)
```

8.5.72 setLoggingLevel

Enables/Disables debug logging (logDebug and logTrace).

0 default, 1 default+debug, 2 default+debug+trace

```
oms.setLoggingLevel(logLevel)
```

8.5.73 setMaxLogFileSize

Sets maximum log file size in MB. If the file exceeds this limit, the logging will continue on stdout.

```
oms.setMaxLogFileSize(size)
```

8.5.74 setReal

Sets the value of a given real signal.

```
status = oms.setReal(cref, value)
```

This function can be called in different model states:

- Before instantiation: *setReal* can be used to set start values or to define initial unknowns (e.g. parameters, states). The values are not immediately applied to the simulation unit, since it isn't actually instantiated.
- After instantiation and before initialization: Same as before instantiation, but the values are applied immediately to the simulation unit.
- After initialization: Can be used to force external inputs, which might cause discrete changes of continuous signals.

8.5.75 setRealInputDerivative

Sets the first order derivative of a real input signal.

This can only be used for CS-FMU real input signals.

```
status = oms.setRealInputDerivative(cref, value)
```

8.5.76 setResultFile

Set the result file of the simulation.

```
status = oms.setResultFile(cref, filename)
status = oms.setResultFile(cref, filename, bufferSize)
```

The creation of a result file is omitted if the filename is an empty string.

8.5.77 setSignalFilter

```
status = oms.setSignalFilter(cref, regex)
```

8.5.78 setSolver

Sets the solver method for the given system.

```
status = oms.setSolver(cref, solver)
```

8.5.79 setStartTime

Set the start time of the simulation.

```
status = oms.setStartTime(cref, startTime)
```

8.5.80 setStopTime

Set the stop time of the simulation.

```
status = oms.setStopTime(cref, stopTime)
```

8.5.81 setTLMBusGeometry

```
# not available
```

8.5.82 setTLMConnectionParameters

Simulates a composite model in its own thread.

```
# not available
```

8.5.83 setTLMPositionAndOrientation

Sets initial position and orientation for a TLM 3D interface.

```
# not yet available
```

8.5.84 setTLMSocketData

Sets data for TLM socket communication.

```
# not yet available
```

8.5.85 setTempDirectory

Set new temp directory.

```
status = oms.setTempDirectory(newTempDir)
```

8.5.86 setTolerance

Sets the tolerance for a given model or system.

```
status = oms.setTolerance(const char* cref, double tolerance)
status = oms.setTolerance(const char* cref, double absoluteTolerance, double_
↪relativeTolerance)
```

Default values are $1e-4$ for both relative and absolute tolerances.

A tolerance specified for a model is automatically applied to its root system, i.e. both calls do exactly the same:

```
oms_setTolerance("model", absoluteTolerance, relativeTolerance);
oms_setTolerance("model.root", absoluteTolerance, relativeTolerance);
```

Component, e.g. FMUs, pick up the tolerances from there system. That means it is not possible to define different tolerances for FMUs in the same system right now.

In a strongly coupled system (*oms_system_sc*), the relative tolerance is used for CVODE and the absolute tolerance is used to solve algebraic loops.

In a weakly coupled system (*oms_system_wc*), both the relative and absolute tolerances are used for the adaptive step master algorithms and the absolute tolerance is used to solve algebraic loops.

8.5.87 setVariableStepSize

Sets the step size parameters for methods with stepsize control.

```
status = oms.getVariableStepSize(cref, initialStepSize, minimumStepSize, ↵  
↵maximumStepSize)
```

8.5.88 setWorkingDirectory

Set a new working directory.

```
status = oms.setWorkingDirectory(newWorkingDir)
```

8.5.89 simulate

Simulates a composite model.

```
status = oms.simulate(cref)
```

8.5.90 simulate_asynchronous

Simulates a composite model in its own thread.

```
# not available
```

8.5.91 simulate_realtime

Experimental feature for (soft) real-time simulation.

```
# not yet available
```

8.5.92 stepUntil

Simulates a composite model until a given time value.

```
status = oms.stepUntil(cref, stopTime)
```

8.5.93 terminate

Terminates a given composite model.

```
status = oms.terminate(cref)
```

8.6 OpenModelicaScripting

This is a shared library that provides a OpenModelica Scripting interface for the OMSimulatorLib library.

```
loadOMSimulator();
oms_setTempDirectory("./temp/");
oms_newModel("model");
oms_addSystem("model.root", OpenModelica.Scripting.oms_system.oms_system_sc);

// instantiate FMUs
oms_addSubModel("model.root.system1", "FMUs/System1.fmu");
oms_addSubModel("model.root.system2", "FMUs/System2.fmu");

// add connections
oms_addConnection("model.root.system1.y", "model.root.system2.u");
oms_addConnection("model.root.system2.y", "model.root.system1.u");

// simulation settings
oms_setResultFile("model", "results.mat");
oms_setStopTime("model", 0.1);
oms_setFixedStepSize("model.root", 1e-4);

oms_instantiate("model");
oms_setReal("model.root.system1.x_start", 2.5);

oms_initialize("model");
oms_simulate("model");
oms_terminate("model");
oms_delete("model");
unloadOMSimulator();
```

8.6.1 RunFile

Simulates a single FMU or SSP model.

```
# not available
```

8.6.2 addBus

Adds a bus to a given component.

```
status := oms_addBus(cref);
```

8.6.3 addConnection

Adds a new connection between connectors *A* and *B*. The connectors need to be specified as fully qualified component references, e.g., *"model.system.component.signal"*.

```
status := oms_addConnection(crefA, crefB);
```

The two arguments *crefA* and *crefB* get swapped automatically if necessary.

8.6.4 addConnector

Adds a connector to a given component.

```
status := oms_addConnector(cref, causality, type);
```

The second argument "causality", should be any of the following,

```
"OpenModelica.Scripting.oms_causality.oms_causality_input"
"OpenModelica.Scripting.oms_causality.oms_causality_output"
"OpenModelica.Scripting.oms_causality.oms_causality_parameter"
"OpenModelica.Scripting.oms_causality.oms_causality_bidir"
"OpenModelica.Scripting.oms_causality.oms_causality_undefined"
```

The third argument **type**, should be any of the following,

```
"OpenModelica.Scripting.oms_signal_type.oms_signal_type_real"
"OpenModelica.Scripting.oms_signal_type.oms_signal_type_integer"
"OpenModelica.Scripting.oms_signal_type.oms_signal_type_boolean"
"OpenModelica.Scripting.oms_signal_type.oms_signal_type_string"
"OpenModelica.Scripting.oms_signal_type.oms_signal_type_enum"
"OpenModelica.Scripting.oms_signal_type.oms_signal_type_bus"
```

8.6.5 addConnectorToBus

Adds a connector to a bus.

```
status := oms_addConnectorToBus(busCref, connectorCref);
```

8.6.6 addConnectorToTLMBus

Adds a connector to a TLM bus.

```
status := oms_addConnectorToTLMBus(busCref, connectorCref, type);
```

8.6.7 addExternalModel

Adds an external model to a TLM system.

```
status := oms_addExternalModel(cref, path, startscript);
```

8.6.8 addSignalsToResults

Add all variables that match the given regex to the result file.

```
status := oms_addSignalsToResults(cref, regex);
```

The second argument, i.e. regex, is considered as a regular expression (C++11). "." and "(.)" can be used to hit all variables.

8.6.13 cancelSimulation_asynchronous

Cancels a running asynchronous simulation.

```
status := oms_cancelSimulation_asynchronous(cref);
```

8.6.14 compareSimulationResults

This function compares a given signal of two result files within absolute and relative tolerances.

```
status := oms_compareSimulationResults(filenameA, filenameB, var, relTol, absTol);
```

The following table describes the input values:

Input	Type	Description
filenameA	String	Name of first result file to compare.
filenameB	String	Name of second result file to compare.
var	String	Name of signal to compare.
relTol	Number	Relative tolerance.
absTol	Number	Absolute tolerance.

The following table describes the return values:

Type	Description
Integer	1 if the signal is considered as equal, 0 otherwise

8.6.15 copySystem

Copies a system.

```
status := oms_copySystem(source, target);
```

8.6.16 delete

Deletes a connector, component, system, or model object.

```
status := oms_delete(cref);
```

8.6.17 deleteConnection

Deletes the connection between connectors *crefA* and *crefB*.

```
status := oms_deleteConnection(crefA, crefB);
```

The two arguments *crefA* and *crefB* get swapped automatically if necessary.

8.6.18 deleteConnectorFromBus

Deletes a connector from a given bus.

```
status := oms_deleteConnectorFromBus(busCref, connectorCref);
```

8.6.19 deleteConnectorFromTLMBus

Deletes a connector from a given TLM bus.

```
status := oms_deleteConnectorFromTLMBus(busCref, connectorCref);
```

8.6.20 export

Exports a composite model to a SPP file.

```
status := oms_export(cref, filename);
```

8.6.21 exportDependencyGraphs

Export the dependency graphs of a given model to dot files.

```
status := oms_exportDependencyGraphs(cref, initialization, simulation);
```

8.6.22 extractFMKind

Extracts the FMI kind of a given FMU from the file system.

```
(kind,status) := oms_extractFMKind(filename);
```

8.6.23 faultInjection

Defines a new fault injection block.

```
status := oms_faultInjection(cref, type, value);
```

The second argument **type**, can be any of the following described below

```
"OpenModelica.Scripting.oms_fault_type.oms_fault_type_bias"
"OpenModelica.Scripting.oms_fault_type.oms_fault_type_gain"
"OpenModelica.Scripting.oms_fault_type.oms_fault_type_const"
```

type	Description"
oms_fault_type_bias	y = y.\$original + faultValue
oms_fault_type_gain	y = y.\$original * faultValue
oms_fault_type_const	y = faultValue

8.6.24 freeMemory

Free the memory allocated by some other API. Pass the object for which memory is allocated.

This function is not needed for OpenModelicaScripting Interface

8.6.25 getBoolean

Get boolean value of given signal.

```
(value, status) := oms_getBoolean(cref);
```

8.6.26 getBus

Gets the bus object.

```
# not available
```

8.6.27 getComponentType

Gets the type of the given component.

```
# not available
```

8.6.28 getConnections

Get list of all connections from a given component.

```
# not available
```

8.6.29 getConnector

Gets the connector object of the given connector cref.

```
# not available
```

8.6.30 getElement

Get element information of a given component reference.

```
# not available
```

8.6.31 getElements

Get list of all sub-components of a given component reference.

```
# not available
```

8.6.32 getFMUInfo

Returns FMU specific information.

```
# not available
```

8.6.33 getFixedStepSize

Gets the fixed step size. Can be used for the communication step size of co-simulation systems and also for the integrator step size in model exchange systems.

```
(stepSize, status) := oms_setFixedStepSize(cref);
```

8.6.34 getInteger

Get integer value of given signal.

```
(value, status) := oms_getInteger(cref);
```

8.6.35 getModelState

Gets the model state of the given model cref.

```
(modelState, status) := oms_getModelState(cref);
```

8.6.36 getReal

Get real value.

```
(value, status) := oms_getReal(cref);
```

8.6.37 getResultFile

Gets the result filename and buffer size of the given model cref.

```
# not available
```

8.6.38 getSignalFilter

Gets the signal filter of the given model cref.

```
# not available
```

8.6.39 getSolver

Gets the selected solver method of the given system.

```
(solver, status) := oms_getSolver(cref);
```

8.6.40 getStartTime

Get the start time from the model.

```
(startTime, status) := oms_getStartTime(cref);
```

8.6.41 getStopTime

Get the stop time from the model.

```
(stopTime, status) := oms_getStopTime(cref);
```

8.6.42 getSubModelPath

Returns the path of a given component.

```
(path, status) := oms_getSubModelPath(cref);
```

8.6.43 getSystemType

Gets the type of the given system.

```
(type, status) := oms_getSystemType(cref);
```

8.6.44 getTLMBus

Gets the TLM bus objects of the given TLM bus cref.

```
# not available
```

8.6.45 getTLMVariableTypes

Gets the type of an TLM variable.

```
# not available
```

8.6.46 getTolerance

Gets the tolerance of a given system or component.

```
(absoluteTolerance, relativeTolerance, status) := oms_getTolerance(cref);
```

8.6.47 getVariableStepSize

Gets the step size parameters.

```
(initialStepSize, minimumStepSize, maximumStepSize, status) := oms_  
↪getVariableStepSize(cref);
```

8.6.48 getVersion

Returns the library's version string.

```
version := oms_getVersion();
```

8.6.49 importFile

Imports a composite model from a SSP file.

```
(cref, status) := oms_importFile(filename);
```

8.6.50 initialize

Initializes a composite model.

```
status := oms_initialize(cref);
```

8.6.51 instantiate

Instantiates a given composite model.

```
status := oms_instantiate(cref);
```

8.6.52 list

Lists the SSD representation of a given model, system, or component.

Memory is allocated for *contents*. The caller is responsible to free it using the C-API. The Lua and Python bindings take care of the memory and the caller doesn't need to call free.

```
(contents, status) := oms_list(cref);
```

8.6.53 listUnconnectedConnectors

Lists all unconnected connectors of a given system.

Memory is allocated for *contents*. The caller is responsible to free it using the C-API. The Lua and Python bindings take care of the memory and the caller doesn't need to call free.

```
(contents, status) := oms_listUnconnectedConnectors(cref);
```

8.6.54 loadSnapshot

Loads a snapshot to restore a previous model state. The model must be in virgin model state, which means it must not be instantiated.

```
status := oms_loadSnapshot(cref, snapshot);
```

8.6.55 newModel

Creates a new and yet empty composite model.

```
status := oms_newModel(cref);
```

8.6.56 parseModelName

Parses the model name from a given SSD representation.

Memory is allocated for *ident*. The caller is responsible to free it using the C-API. The Lua and Python bindings take care of the memory and the caller doesn't need to call free.

```
(ident, status) := oms_parseModelName(contents);
```

8.6.57 removeSignalsFromResults

Removes all variables that match the given regex to the result file.

```
status := oms_removeSignalsFromResults(cref, regex);
```

The second argument, i.e. regex, is considered as a regular expression (C++11). `".*"` and `"(.)*"` can be used to hit all variables.

8.6.58 rename

Renames a model, system, or component.

```
status := oms_rename(cref, newCref);
```

8.6.59 reset

Reset the composite model after a simulation run.

The FMUs go into the same state as after instantiation.

```
status := oms_reset(cref);
```

8.6.60 setActivationRatio

Experimental feature for setting the activation ratio of FMUs for experimenting with multi-rate master algorithms.

```
# not yet available
```

8.6.61 setBoolean

Sets the value of a given boolean signal.

```
status := oms_setBoolean(cref, value);
```

8.6.62 setBusGeometry

```
# not available
```

8.6.63 setCommandLineOption

Sets special flags.

```
status := oms_setCommandLineOption(cmd);
```

Available flags:

```
info:      Usage: OMSimulator [Options] [Lua script] [FMU] [SSP file]
           Options:
             --addParametersToCSV=<arg>      Export parameters to .csv file (true, ↵
↵[false])
             --clearAllOptions                Reset all flags to default values
             --deleteTempFiles=<bool>        Deletes temp files as soon as they are ↵
↵no longer needed ([true], false)
             --emitEvents=<bool>             Specifies whether events should be ↵
↵emitted or not ([true], false)
             --exportParametersInline=<arg>  Export ParameterBindings inline with ↵
↵.ssd file,
             --fetchAllVars=<arg>           Workaround for certain FMUs that do not ↵
↵update all internal dependencies automatically
             --help [-h]                    Displays the help text
             --ignoreInitialUnknowns=<bool> Ignore the initial unknowns from the ↵
↵modelDescription.xml (true, [false])
             --inputExtrapolation=<bool>     Enables input extrapolation using ↵
↵derivative information (true, [false])
             --intervals=<int> [-i]         Specifies the number of communication ↵
↵points (arg > 1)
             --logFile=<arg> [-l]           Specifies the logfile (stdout is used ↵
↵if no log file is specified)
             --logLevel=<int>              0 default, 1 debug, 2 debug+trace
             --maxEventIteration=<int>     Specifies the max. number of iterations ↵
↵for handling a single event
```

(continues on next page)

(continued from previous page)

<pre> --maxLoopIteration=<int> ↳for solving algebraic loops between system-level components. Internal algebraic ↳loops of components are not affected. --mode=<arg> [-m] ↳provides cs and me (cs, [me]) --numProcs=<int> [-n] ↳to use (0=auto, 1=default) --progressBar=<bool> ↳progress in the terminal (true, [false]) --realTime=<bool> ↳time co-simulation (true, [false]) --resultFile=<arg> [-r] ↳file --setInputDerivatives=<bool> --skipCSVHeader=<arg> ↳header (true, [false]), --solver=<arg> ↳ [cvsode]) --solverStats=<bool> ↳g. step size; not supported for all solvers (true, [false]) --startTime=<double> [-s] --stopTime=<double> [-t] --stripRoot=<bool> ↳exported signals (true, [false]) --suppressPath=<bool> ↳messages; especially useful for testing (true, [false]) --tempDir=<arg> --timeout=<int> ↳seconds for running a simulation (0 disables) --tolerance=<double> --version [-v] --wallTime=<bool> ↳result file (true, [false]) --workingDir=<arg> </pre>	<pre> Specifies the max. number of iterations. Forces a certain FMI mode iff the FMU Specifies the max. number of processors. Shows a progress bar for the simulation Experimental feature for (soft) real- Specifies the name of the output result. Deprecated; see '--inputExtrapolation' Skip exporting the scv delimiter in the Specifies the integration method (euler, Adds solver stats to the result file, e. Specifies the start time Specifies the stop time Removes the root system prefix from all Supresses path information in info Specifies the temp directory Specifies the maximum allowed time in Specifies the relative tolerance Displays version information Add wall time information for to the Specifies the working directory </pre>
--	--

8.6.64 setConnectionGeometry

```
# not available
```

8.6.65 setConnectorGeometry

Set geometry information to a given connector.

```
# not available
```

8.6.66 setElementGeometry

Set geometry information to a given component.

```
# not available
```

8.6.67 setFixedStepSize

Sets the fixed step size. Can be used for the communication step size of co-simulation systems and also for the integrator step size in model exchange systems.

```
status := oms_setFixedStepSize(cref, stepSize);
```

8.6.68 setInteger

Sets the value of a given integer signal.

```
status := oms_setInteger(cref, value);
```

8.6.69 setLogFile

Redirects logging output to file or std streams. The warning/error counters are reset.

filename="" to redirect to std streams and proper filename to redirect to file.

```
status := oms_setLogFile(filename);
```

8.6.70 setLoggingCallback

Sets a callback function for the logging system.

```
# not available
```

8.6.71 setLoggingInterval

Set the logging interval of the simulation.

```
status := oms_setLoggingInterval(cref, loggingInterval);
```

8.6.72 setLoggingLevel

Enables/Disables debug logging (logDebug and logTrace).

0 default, 1 default+debug, 2 default+debug+trace

```
oms_setLoggingLevel(logLevel);
```

8.6.73 setMaxLogFileSize

Sets maximum log file size in MB. If the file exceeds this limit, the logging will continue on stdout.

```
# not available
```

8.6.74 setReal

Sets the value of a given real signal.

```
status := oms_setReal(cref, value);
```

This function can be called in different model states:

- Before instantiation: *setReal* can be used to set start values or to define initial unknowns (e.g. parameters, states). The values are not immediately applied to the simulation unit, since it isn't actually instantiated.
- After instantiation and before initialization: Same as before instantiation, but the values are applied immediately to the simulation unit.
- After initialization: Can be used to force external inputs, which might cause discrete changes of continuous signals.

8.6.75 setRealInputDerivative

Sets the first order derivative of a real input signal.

This can only be used for CS-FMU real input signals.

```
status := oms_setRealInputDerivative(cref, value);
```

8.6.76 setResultFile

Set the result file of the simulation.

```
status := oms_setResultFile(cref, filename);
status := oms_setResultFile(cref, filename, bufferSize);
```

The creation of a result file is omitted if the filename is an empty string.

8.6.77 setSignalFilter

```
status := oms_setSignalFilter(cref, regex);
```

8.6.78 setSolver

Sets the solver method for the given system.

```
status := oms_setSolver(cref, solver);
```

The second argument "solver" should be any of the following,

```
"OpenModelica.Scripting.oms_solver.oms_solver_none"
"OpenModelica.Scripting.oms_solver.oms_solver_sc_min"
"OpenModelica.Scripting.oms_solver.oms_solver_sc_explicit_euler"
"OpenModelica.Scripting.oms_solver.oms_solver_sc_cvode"
"OpenModelica.Scripting.oms_solver.oms_solver_sc_max"
"OpenModelica.Scripting.oms_solver.oms_solver_wc_min"
"OpenModelica.Scripting.oms_solver.oms_solver_wc_ma"
"OpenModelica.Scripting.oms_solver.oms_solver_wc_mav"
"OpenModelica.Scripting.oms_solver.oms_solver_wc_assc"
"OpenModelica.Scripting.oms_solver.oms_solver_wc_mav2"
"OpenModelica.Scripting.oms_solver.oms_solver_wc_max"
```

8.6.79 setStartTime

Set the start time of the simulation.

```
status := oms_setStartTime(cref, startTime);
```

8.6.80 setStopTime

Set the stop time of the simulation.

```
status := oms_setStopTime(cref, stopTime);
```

8.6.81 setTLMBusGeometry

```
# not available
```

8.6.82 setTLMConnectionParameters

Simulates a composite model in its own thread.

```
# not available
```

8.6.83 setTLMPositionAndOrientation

Sets initial position and orientation for a TLM 3D interface.

```
status := oms_setTLMPositionAndOrientation(cref, x1, x2, x3, A11, A12, A13, A21, ↵  
↵A22, A23, A31, A32, A33);
```

8.6.84 setTLMSocketData

Sets data for TLM socket communication.

```
status := oms_setTLMSocketData(cref, address, managerPort, monitorPort);
```

8.6.85 setTempDirectory

Set new temp directory.

```
status := oms_setTempDirectory(newTempDir);
```

8.6.86 setTolerance

Sets the tolerance for a given model or system.

```
status := oms_setTolerance(const char* cref, double tolerance);  
status := oms_setTolerance(const char* cref, double absoluteTolerance, double ↵  
↵relativeTolerance);
```

Default values are $1e-4$ for both relative and absolute tolerances.

A tolerance specified for a model is automatically applied to its root system, i.e. both calls do exactly the same:

```
oms_setTolerance("model", absoluteTolerance, relativeTolerance);
oms_setTolerance("model.root", absoluteTolerance, relativeTolerance);
```

Component, e.g. FMUs, pick up the tolerances from there system. That means it is not possible to define different tolerances for FMUs in the same system right now.

In a strongly coupled system (*oms_system_sc*), the relative tolerance is used for CVODE and the absolute tolerance is used to solve algebraic loops.

In a weakly coupled system (*oms_system_wc*), both the relative and absolute tolerances are used for the adaptive step master algorithms and the absolute tolerance is used to solve algebraic loops.

8.6.87 setVariableStepSize

Sets the step size parameters for methods with stepsize control.

```
status := oms_getVariableStepSize(cref, initialStepSize, minimumStepSize, ↵
↵maximumStepSize);
```

8.6.88 setWorkingDirectory

Set a new working directory.

```
status := oms_setWorkingDirectory(newWorkingDir);
```

8.6.89 simulate

Simulates a composite model.

```
status := oms_simulate(cref);
```

8.6.90 simulate_asynchronous

Simulates a composite model in its own thread.

```
# not available
```

8.6.91 simulate_realtime

Experimental feature for (soft) real-time simulation.

```
# not yet available
```

8.6.92 stepUntil

Simulates a composite model until a given time value.

```
status := oms_stepUntil(cref, stopTime);
```

8.6.93 terminate

Terminates a given composite model.

```
status := oms_terminate(cref);
```

8.7 Graphical Modelling

OMSimulator has an optional dependency to OpenModelica in order to utilize the graphical modelling editor OMEdit. This feature requires to install the full OpenModelica tool suite, which includes OMSimulator. The independent stand-alone version doesn't provide any graphical modelling editor.

See also [FMI documentation](#).

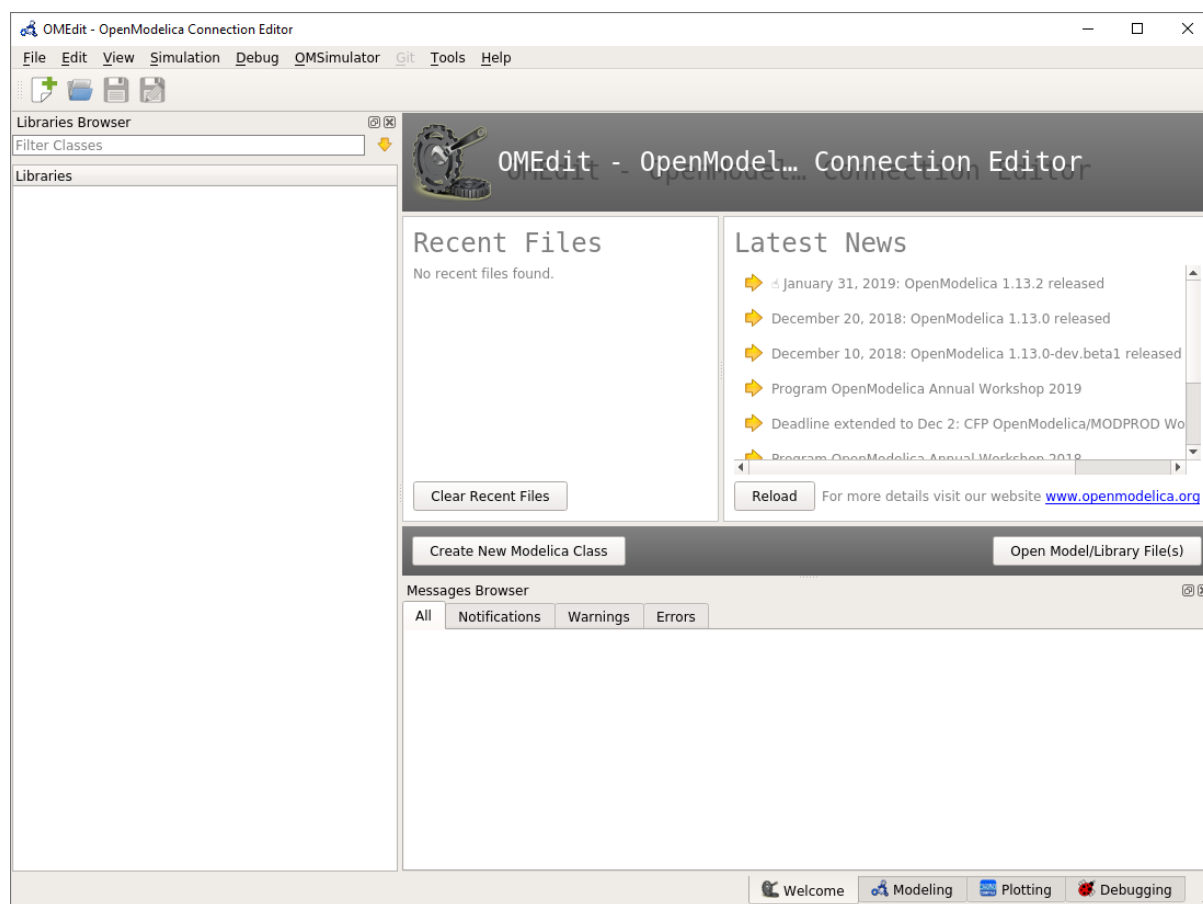

Figure 8.1: OMEdit MainWindow and Browsers.

8.7.1 New OMSimulator Model

A new and empty OMSimulator model can be created from the OMSimulator menu item.

That will pop-up a dialog to enter the names of the model and the root system.

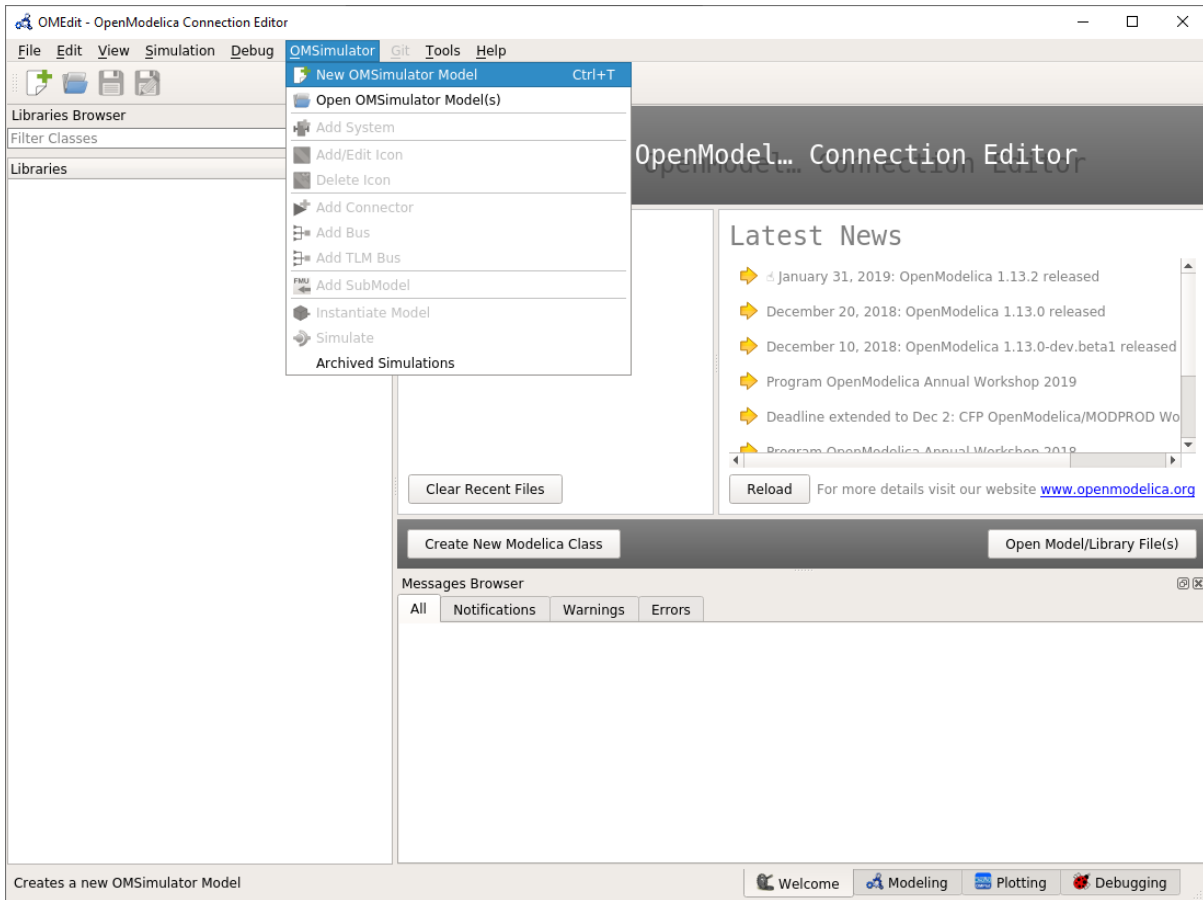

Figure 8.2: OMEdit: New OMSimulator Model

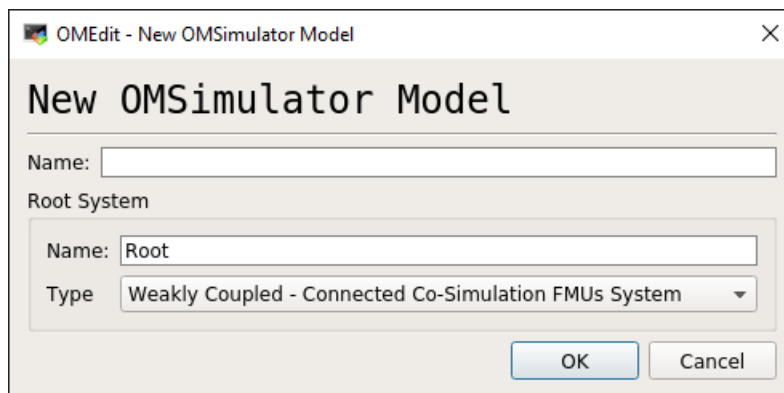

Figure 8.3: OMEdit: New OMSimulator Model Dialog

8.7.2 Add System

A weakly coupled system (co-simulation) can integrate strongly coupled system (model exchange). Therefore, the weakly coupled system must to be selected from the Libraries Browser and the respective menu item can be selected:

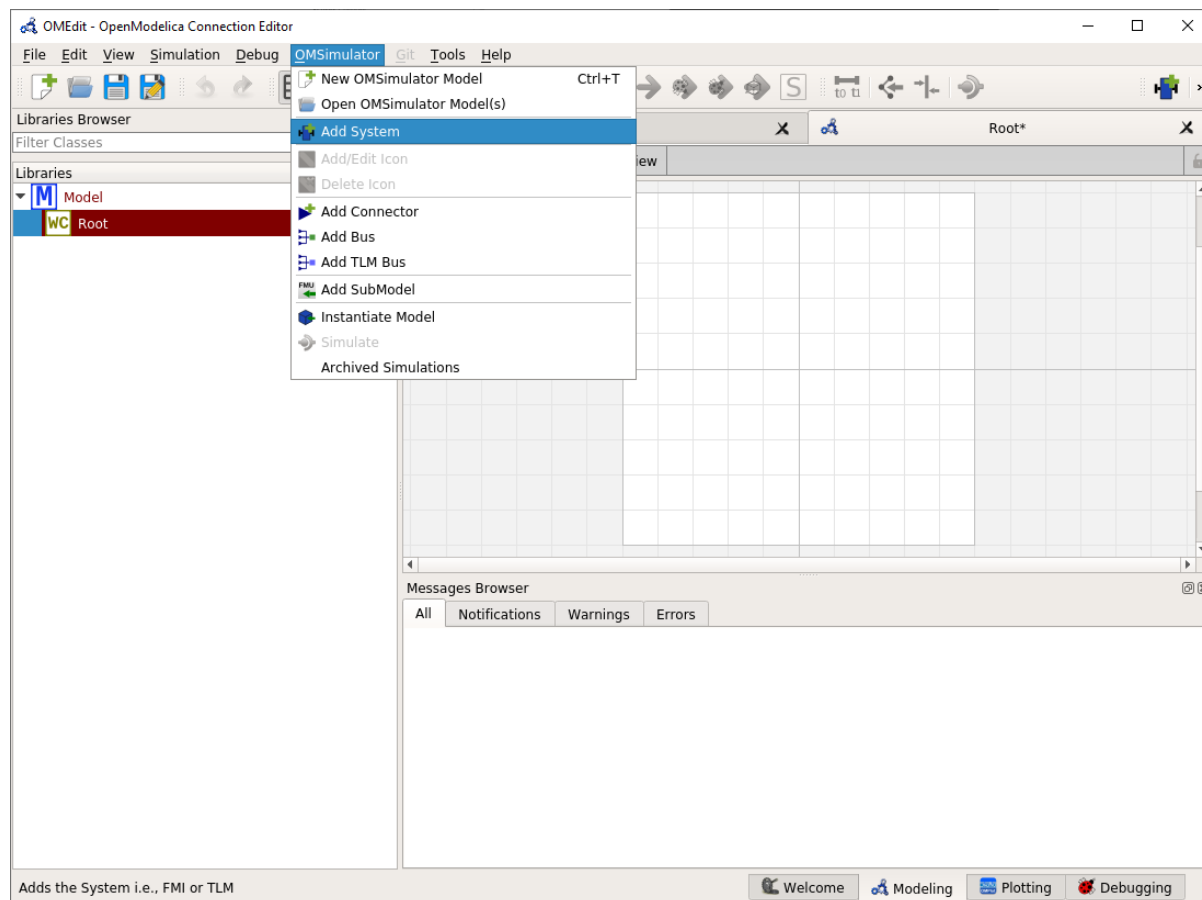

Figure 8.4: OMEdit: Add System

That will pop-up a dialog to enter the names of the new system.

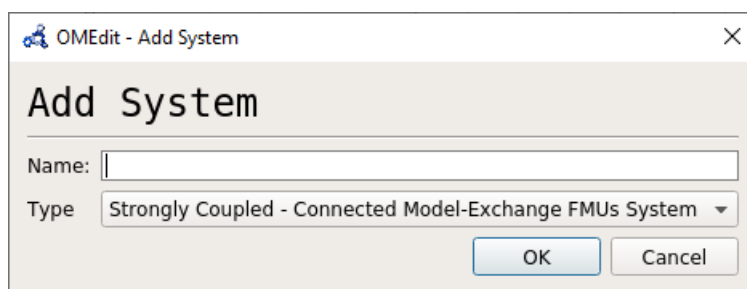

Figure 8.5: OMEdit: Add System Dialog

8.7.3 Add SubModel

A sub-model is typically an FMU, but it also can be result file. In order to import a sub-model, the respective system must be selected and the action can be selected from the menu bar:

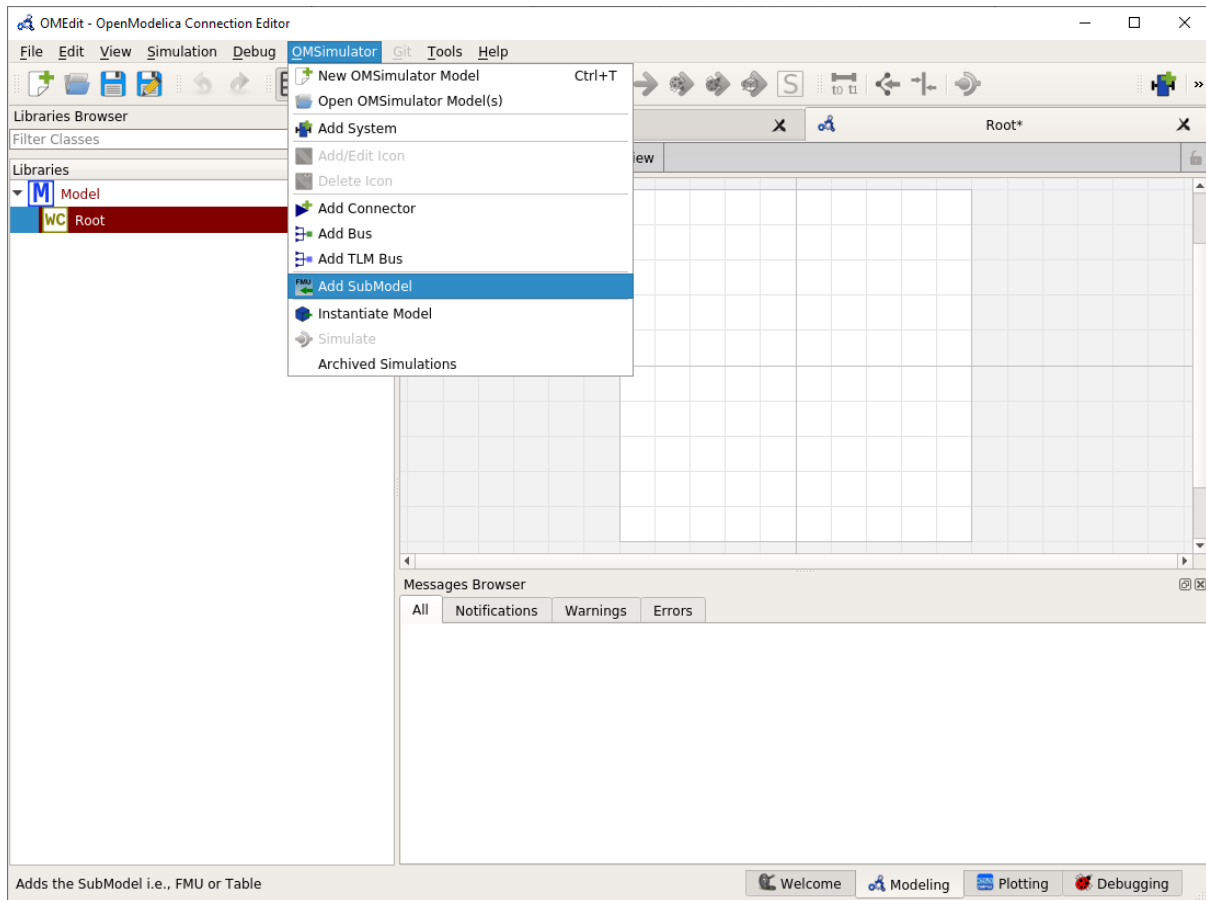

Figure 8.6: OMEdit: Add SubModel

That will pop-up a dialog to enter the names of the new sub-model.

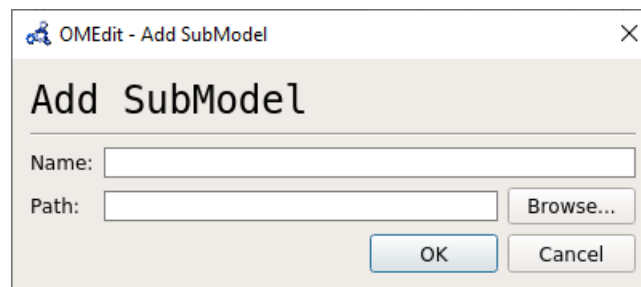

Figure 8.7: OMEdit: Add SubModel Dialog

8.7.4 Instantiate Model

Before a OMSimulator model can be simulated, it needs to be instantiated. Therefore, select the dedicated menu item:

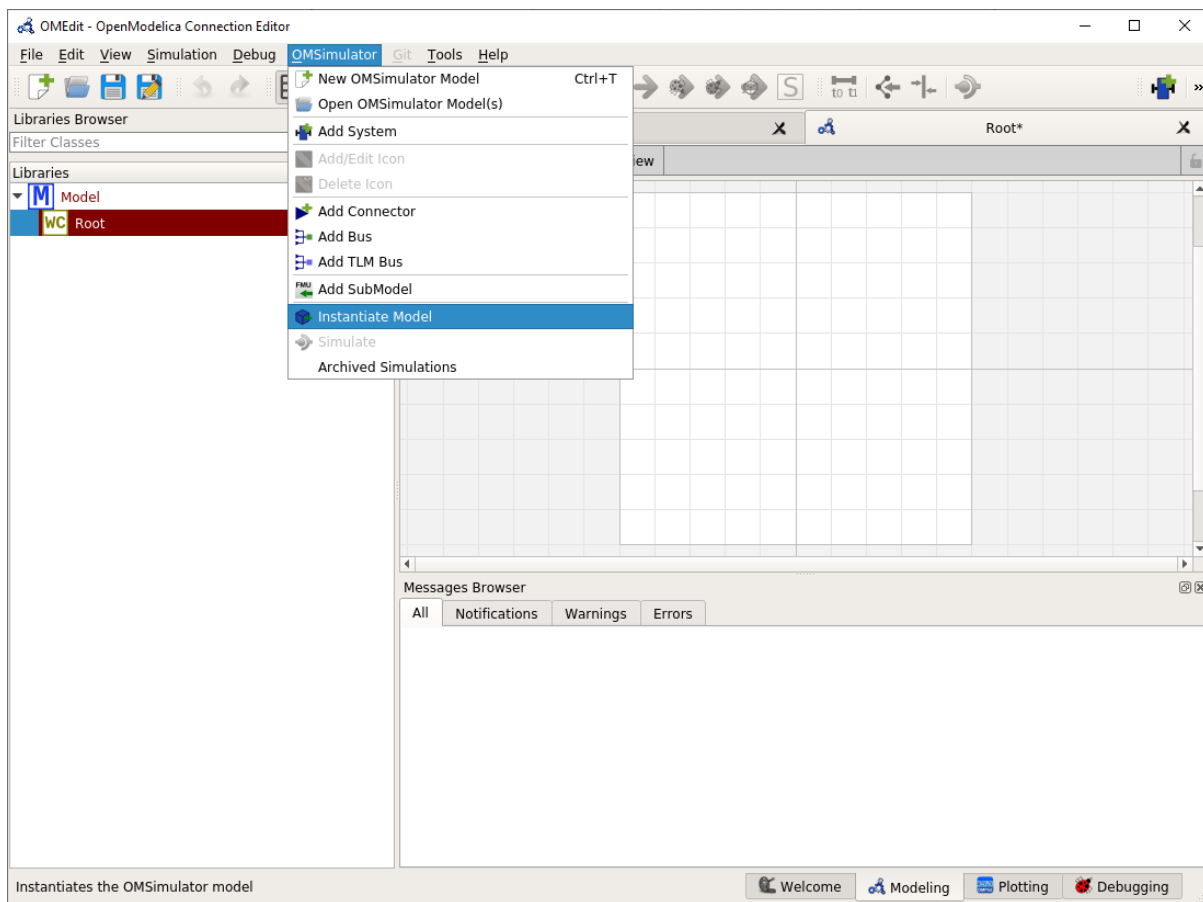

Figure 8.8: OMEdit: Instantiate Model

That will pop-up a dialog to enter various simulation settings.

8.7.5 Simulate

Select the simulate item from the OMSimulator menu.

8.8 SSP Support

Composite models are imported and exported in the *System Structure Description (SSD)* format, which is part of the *System Structure and Parameterization (SSP)* standard.

Bus connections are saved as annotations to the SSD file. Bus connectors are only allowed in weakly coupled and strongly coupled systems. Bus connectors can exist in any system type. Bus connectors are used to hide SSD connectors and bus connections are used to hide existing SSD connections in the graphical user interface. It is not required that all connectors referenced in a bus are connected. One bus may be connected to multiple other buses, and also to SSD connectors.

The example below contains a root system with two subsystems, WC1 and WC2. Bus connector WC1.bus1 is connected to WC2.bus2. Bus connector WC2.bus2 is also connected to SSD connector WC1.C3.

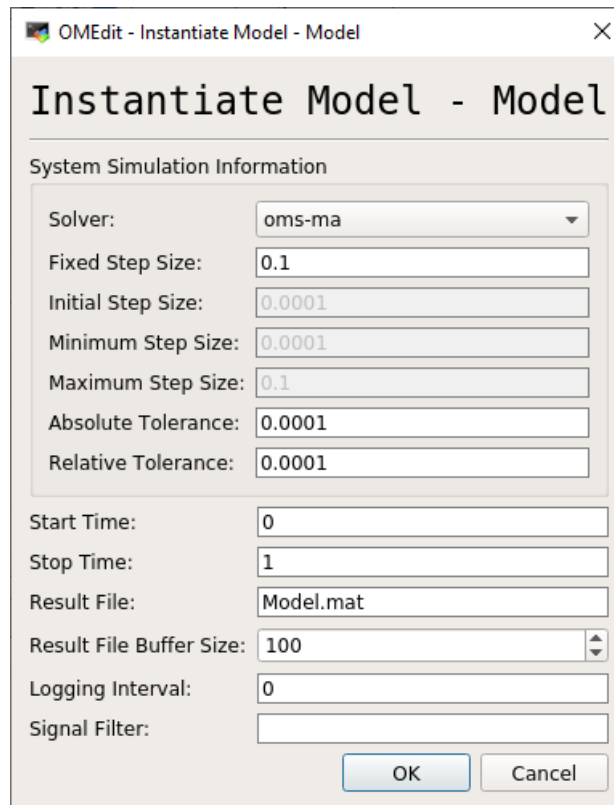

Figure 8.9: OMEdit: Instantiate Model Dialog

```

<?xml version="1.0" encoding="UTF-8"?>
<ssd:SystemStructureDescription name="Test" version="Draft20180219">
  <ssd:System name="Root">
    <ssd:Elements>
      <ssd:System name="WC2">
        <ssd:Connectors>
          <ssd:Connector name="C1" kind="input" type="Real"/>
          <ssd:Connector name="C2" kind="output" type="Real"/>
        </ssd:Connectors>
        <ssd:Annotations>
          <ssc:Annotation type="org.openmodelica">
            <oms:Bus name="bus2">
              <oms:Signals>
                <oms:Signal name="C1"/>
                <oms:Signal name="C2"/>
              </oms:Signals>
            </oms:Bus>
          </ssc:Annotation>
        </ssd:Annotations>
      </ssd:System>
      <ssd:System name="WC1">
        <ssd:Connectors>
          <ssd:Connector name="C1" kind="output" type="Real"/>
          <ssd:Connector name="C2" kind="input" type="Real"/>
          <ssd:Connector name="C3" kind="input" type="Real"/>
        </ssd:Connectors>
        <ssd:Annotations>
          <ssc:Annotation type="org.openmodelica">
            <oms:Bus name="bus1">
              <oms:Signals>

```

(continues on next page)

(continued from previous page)

```

        <oms:Signal name="C1"/>
        <oms:Signal name="C2"/>
    </oms:Signals>
</oms:Bus>
</ssc:Annotation>
</ssd:Annotations>
</ssd:System>
</ssd:Elements>
<ssd:Connections>
  <ssd:Connection startElement="WC2" startConnector="C1"
    endElement="WC1" endConnector="C1"/>
  <ssd:Connection startElement="WC2" startConnector="C2"
    endElement="WC1" endConnector="C2"/>
  <ssd:Connection startElement="WC2" startConnector="C2"
    endElement="WC1" endConnector="C3"/>
</ssd:Connections>
<ssd:Annotations>
  <ssc:Annotation type="org.openmodelica">
    <oms:Connections>
      <oms:Connection startElement="WC1" startConnector="bus1"
        endElement="WC2" endConnector="bus2"/>
      <oms:Connection startElement="WC2" startConnector="bus2"
        endElement="WC1" endConnector="C3"/>
    </oms:Connections>
  </ssc:Annotation>
</ssd:Annotations>
</ssd:System>
</ssd:SystemStructureDescription>

```

TLM systems are only allowed on top-level. SSD annotations are used to specify the system type inside the `ssd:SimulationInformation` tag, as shown in the example below. Attributes `ip`, `managerport` and `monitorport` defines the socket communication, used both to exchange data with external tools and with internal simulation threads.

```

<?xml version="1.0"?>
<ssd:System name="tlm">
  <ssd:SimulationInformation>
    <ssd:Annotations>
      <ssd:Annotation type="org.openmodelica">
        <oms:TlmMaster ip="127.0.1.1" managerport="11111" monitorport="11121"/>
      </ssd:Annotation>
    </ssd:Annotations>
  </ssd:SimulationInformation>
  <ssd:Elements>
    <ssd:System name="weaklycoupled">
      <ssd:SimulationInformation>
        <ssd:FixedStepMaster description="oms-ma" stepSize="1e-1" />
      </ssd:SimulationInformation>
    </ssd:System>
  </ssd:Elements>
</ssd:System>

```

TLM connections are implemented without regular SSD connections. TLM connections are only allowed in TLM systems. TLM connectors are only allowed in weakly coupled or strongly coupled systems. Both connectors and connections are implemented as SSD annotations in the `System` tag.

The example below shows a TLM system containing two weakly coupled systems, `wc1` and `wc2`. System `wc1` contains two TLM connectors, one of type 1D signal and one of type 1D mechanical. System `wc2` contains only a 1D signal type connector. The two 1D signal connectors are connected to each other in the TLM top-level system.

```

<?xml version="1.0"?>

```

(continues on next page)

(continued from previous page)

```

<ssd:System name="t1m">
  <ssd:Elements>
    <ssd:System name="wc2">
      <ssd:Connectors>
        <ssd:Connector name="y" kind="input" type="Real" />
      </ssd:Connectors>
      <ssd:Annotations>
        <ssd:Annotation type="org.openmodelica">
          <oms:Bus name="bus2" type="t1m" domain="signal"
            dimension="1" interpolation="none">
            <oms:Signals>
              <oms:Signal name="y" t1mType="value" />
            </oms:Signals>
          </oms:Bus>
        </ssd:Annotation>
      </ssd:Annotations>
    </ssd:System>
    <ssd:System name="wc1">
      <ssd:Connectors>
        <ssd:Connector name="y" kind="output" type="Real" />
        <ssd:Connector name="x" kind="output" type="Real" />
        <ssd:Connector name="v" kind="output" type="Real" />
        <ssd:Connector name="f" kind="input" type="Real" />
      </ssd:Connectors>
      <ssd:Annotations>
        <ssd:Annotation type="org.openmodelica">
          <oms:Bus name="bus1" type="t1m" domain="signal"
            dimension="1" interpolation="none">
            <oms:Signals>
              <oms:Signal name="y" t1mType="value" />
            </oms:Signals>
          </oms:Bus>
          <oms:Bus name="bus2" type="t1m" domain="mechanical"
            dimension="1" interpolation="none">
            <oms:Signals>
              <oms:Signal name="x" t1mType="state" />
              <oms:Signal name="v" t1mType="flow" />
              <oms:Signal name="f" t1mType="effort" />
            </oms:Signals>
          </oms:Bus>
        </ssd:Annotation>
      </ssd:Annotations>
    </ssd:System>
  </ssd:Elements>
  <ssd:Annotations>
    <ssd:Annotation type="org.openmodelica">
      <oms:Connections>
        <oms:Connection startElement="wc1" startConnector="bus1"
          endElement="wc2" endConnector="bus2"
          delay="0.001000" alpha="0.300000"
          linearimpedance="100.000000"
          angularimpedance="0.000000" />
      </oms:Connections>
    </ssd:Annotation>
  </ssd:Annotations>
</ssd:System>

```

Depending on the type of TLM bus connector (dimension, domain and interpolation), connectors need to be assigned to different t1m variable types. Below is the complete list of supported TLM bus types and their respective connectors.

1D signal

tImType	causality
"value"	input/output

1D physical (no interpolation)

tImType	causality
"state"	output
"flow"	output
"effort"	input

1D physical (coarse-grained interpolation)

tImType	causality
"state"	output
"flow"	output
"wave"	input
"impedance"	input

1D physical (fine-grained interpolation)

tImType	causality
"state"	output
"flow"	output
"wave1"	input
"wave2"	input
"wave3"	input
"wave4"	input
"wave5"	input
"wave6"	input
"wave7"	input
"wave8"	input
"wave9"	input
"wave10"	input
"time1"	input
"time2"	input
"time3"	input
"time4"	input
"time5"	input
"time6"	input
"time7"	input
"time8"	input
"time9"	input
"time10"	input
"impedance"	input

3D physical (no interpolation)

tImType	causality
"state1 "	output
"state2 "	output
"state3 "	output
"A11 "	output
"A12 "	output
"A13 "	output
"A21 "	output
"A22 "	output
"A23 "	output
"A31 "	output
"A32 "	output
"A33 "	output
"flow1 "	output
"flow2 "	output
"flow3 "	output
"flow4 "	output
"flow5 "	output
"flow6 "	output
"effort1 "	input
"effort2 "	input
"effort3 "	input
"effort4 "	input
"effort5 "	input
"effort6 "	input

3D physical (coarse-grained interpolation)

tImType	causality
"state1 "	output
"state2 "	output
"state3 "	output
"A11 "	output
"A12 "	output
"A13 "	output
"A21 "	output
"A22 "	output
"A23 "	output
"A31 "	output
"A32 "	output
"A33 "	output
"flow1 "	output
"flow2 "	output
"flow3 "	output
"flow4 "	output
"flow5 "	output
"flow6 "	output
"wave1 "	input
"wave2 "	input
"wave3 "	input
"wave4 "	input
"wave5 "	input
"wave6 "	input
"linearimpedance "	input
"angularimpedance "	input

3D physical (fine-grained interpolation)

tlmType	causality
"state1"	output
"state2"	output
"state3"	output
"A11"	output
"A12"	output
"A13"	output
"A21"	output
"A22"	output
"A23"	output
"A31"	output
"A32"	output
"A33"	output
"flow1"	output
"flow2"	output
"flow3"	output
"flow4"	output
"flow5"	output
"flow6"	output
"wave1_1"	input
"wave1_2"	input
"wave1_3"	input
"wave1_4"	input
"wave1_5"	input
"wave1_6"	input
"wave2_1"	input
"wave2_2"	input
"wave2_3"	input
"wave2_4"	input
"wave2_5"	input
"wave2_6"	input
"wave3_1"	input
"wave3_2"	input
"wave3_3"	input
"wave3_4"	input
"wave3_5"	input
"wave3_6"	input
"wave4_1"	input
"wave4_2"	input
"wave4_3"	input
"wave4_4"	input
"wave4_5"	input
"wave4_6"	input
"wave5_1"	input
"wave5_2"	input
"wave5_3"	input
"wave5_4"	input
"wave5_5"	input
"wave5_6"	input
"wave6_1"	input
"wave6_2"	input
"wave6_3"	input
"wave6_4"	input

continues on next page

Table 8.1 – continued from previous page

tlmType	causality
"wave6_5"	input
"wave6_6"	input
"wave7_1"	input
"wave7_2"	input
"wave7_3"	input
"wave7_4"	input
"wave7_5"	input
"wave7_6"	input
"wave8_1"	input
"wave8_2"	input
"wave8_3"	input
"wave8_4"	input
"wave8_5"	input
"wave8_6"	input
"wave9_1"	input
"wave9_2"	input
"wave9_3"	input
"wave9_4"	input
"wave9_5"	input
"wave9_6"	input
"wave10_1"	input
"wave10_2"	input
"wave10_3"	input
"wave10_4"	input
"wave10_5"	input
"wave10_6"	input
"time1"	input
"time2"	input
"time3"	input
"time4"	input
"time5"	input
"time6"	input
"time7"	input
"time8"	input
"time9"	input
"time10"	input
"linearimpedance"	input
"angularimpedance"	input

SYSTEM IDENTIFICATION

System Identification ([OMSysIdent](#)) is its own separate project and not bundled together with the main OpenModelica distribution.

OPENMODELICA ENCRYPTION

The encryption module allows the library developers to encrypt their libraries for different platforms. Note that you need a special version of OpenModelica with encryption support. Contact us if you want one.

10.1 Encrypting the Library

In order to encrypt the Modelica package call *buildEncryptedPackage(TopLevelPackageName)* from mos script or from **OMEdit** right click the package in Libraries Browser and select *Export Encrypted Package* or select *Export > Export Encrypted Package* from the menu.

All the Modelica files are encrypted and the whole library is zipped into a single file i.e., *PackageName.mol*. Note that you can only encrypt Modelica packages saved in a folder structure. The complete folder structure remains as it is. No encryption is done on the resource files.

10.2 Loading an Encrypted Library

To load the encrypted package call *loadEncryptedPackage(EncryptedPackage.mol)* from the mos script or from **OMEdit** *File > Load Encrypted Package*.

10.3 Notes

- There is no license management and obfuscation of the generated code and files. However just a basic encryption and decryption is supported along with full support for protection access annotation as defined in Modelica specification 18.9. This means that anyone who has an OpenModelica version with encryption support can encrypt or decrypt files.
- OpenModelica encryption is based on SEMLA (Safe/Superiour/Super Encryption of Modelica Libraries and Artifacts) module from Modelon AB.

OMNOTEBOOK WITH DRMODELICA AND DRCONTROL

This chapter covers the OpenModelica electronic notebook subsystem, called OMNotebook, together with the DrModelica tutoring system for teaching Modelica, and DrControl for teaching control together with Modelica. Both are using such notebooks.

11.1 Interactive Notebooks with Literate Programming

Interactive Electronic Notebooks are active documents that may contain technical computations and text, as well as graphics. Hence, these documents are suitable to be used for teaching and experimentation, simulation scripting, model documentation and storage, etc.

11.1.1 Mathematica Notebooks

Literate Programming [Knu84] is a form of programming where programs are integrated with documentation in the same document. Mathematica notebooks [Wol96] is one of the first WYSIWYG (What-You-See-Is-What-You-Get) systems that support Literate Programming. Such notebooks are used, e.g., in the MathModelica modeling and simulation environment, see e.g. Figure 11.1 below and Chapter 19 in [Fri04].

11.1.2 OMNotebook

The OMNotebook software [Axe05][Fernstrom06] is a new open source free software that gives an interactive WYSIWYG realization of Literate Programming, a form of programming where programs are integrated with documentation in the same document.

The OMNotebook facility is actually an interactive WYSIWYG realization of Literate Programming, a form of programming where programs are integrated with documentation in the same document. OMNotebook is a simple open-source software tool for an electronic notebook supporting Modelica.

A more advanced electronic notebook tool, also supporting mathematical typesetting and many other facilities, is provided by Mathematica notebooks in the MathModelica environment, see Figure 11.1.

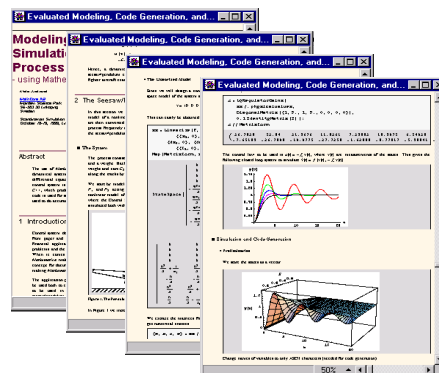

Figure 11.1: Examples of Mathematica notebooks in the MathModelica modeling and simulation environment.

Traditional documents, e.g. books and reports, essentially always have a hierarchical structure. They are divided into sections, subsections, paragraphs, etc. Both the document itself and its sections usually have headings as labels for easier navigation. This kind of structure is also reflected in electronic notebooks. Every notebook corresponds to one document (one file) and contains a tree structure of cells. A cell can have different kinds of contents, and can even contain other cells. The notebook hierarchy of cells thus reflects the hierarchy of sections and subsections in a traditional document such as a book.

11.2 DrModelica Tutoring System – an Application of OMNotebook

Understanding programs is hard, especially code written by someone else. For educational purposes it is essential to be able to show the source code and to give an explanation of it at the same time.

Moreover, it is important to show the result of the source code's execution. In modeling and simulation it is also important to have the source code, the documentation about the source code, the execution results of the simulation model, and the documentation of the simulation results in the same document. The reason is that the problem solving process in computational simulation is an iterative process that often requires a modification of the original mathematical model and its software implementation after the interpretation and validation of the computed results corresponding to an initial model.

Most of the environments associated with equation-based modeling languages focus more on providing efficient numerical algorithms rather than giving attention to the aspects that should facilitate the learning and teaching of the language. There is a need for an environment facilitating the learning and understanding of Modelica. These are the reasons for developing the DrModelica teaching material for Modelica and for teaching modeling and simulation.

An earlier version of DrModelica was developed using the MathModelica (now Wolfram SystemModeler) environment. The rest of this chapter is concerned with the OMNotebook version of DrModelica and on the OMNotebook tool itself.

DrModelica has a hierarchical structure represented as notebooks. The front-page notebook is similar to a table of contents that holds all other notebooks together by providing links to them. This particular notebook is the first page the user will see (Figure 11.2).

In each chapter of DrModelica the user is presented a short summary of the corresponding chapter of the Modelica book [Fri04]. The summary introduces some *keywords*, being hyperlinks that will lead the user to other notebooks describing the keywords in detail.

Now, let us consider that the link “*HelloWorld*” in DrModelica Section is clicked by the user. The new HelloWorld notebook (see Figure 11.3), to which the user is being linked, is not only a textual description but also contains one or more examples explaining the specific keyword. In this class, HelloWorld, a differential equation is specified.

No information in a notebook is fixed, which implies that the user can add, change, or remove anything in a notebook. Alternatively, the user can create an entirely new notebook in order to write his/her own programs or copy examples from other notebooks. This new notebook can be linked from existing notebooks.

When a class has been successfully evaluated the user can simulate and plot the result, as previously depicted in Figure 11.3 for the simple HelloWorld example model.

After reading a chapter in DrModelica the user can immediately practice the newly acquired information by doing the exercises that concern the specific chapter. Exercises have been written in order to elucidate language constructs step by step based on the pedagogical assumption that a student learns better “*using the strategy of learning by doing*”. The exercises consist of either theoretical questions or practical programming assignments. All exercises provide answers in order to give the user immediate feedback.

Figure 11.4 shows part of Chapter 9 of the DrModelica teaching material. Here the user can read about language constructs, like algorithm sections, when-statements, and reinit equations, and then practice these constructs by solving the exercises corresponding to the recently studied section.

Exercise 1 from Chapter 9 is shown in Figure 11.5. In this exercise the user has the opportunity to practice different language constructs and then compare the solution to the answer for the exercise. Notice that the answer is not visible until the *Answer* section is expanded. The answer is shown in Figure 11.6.

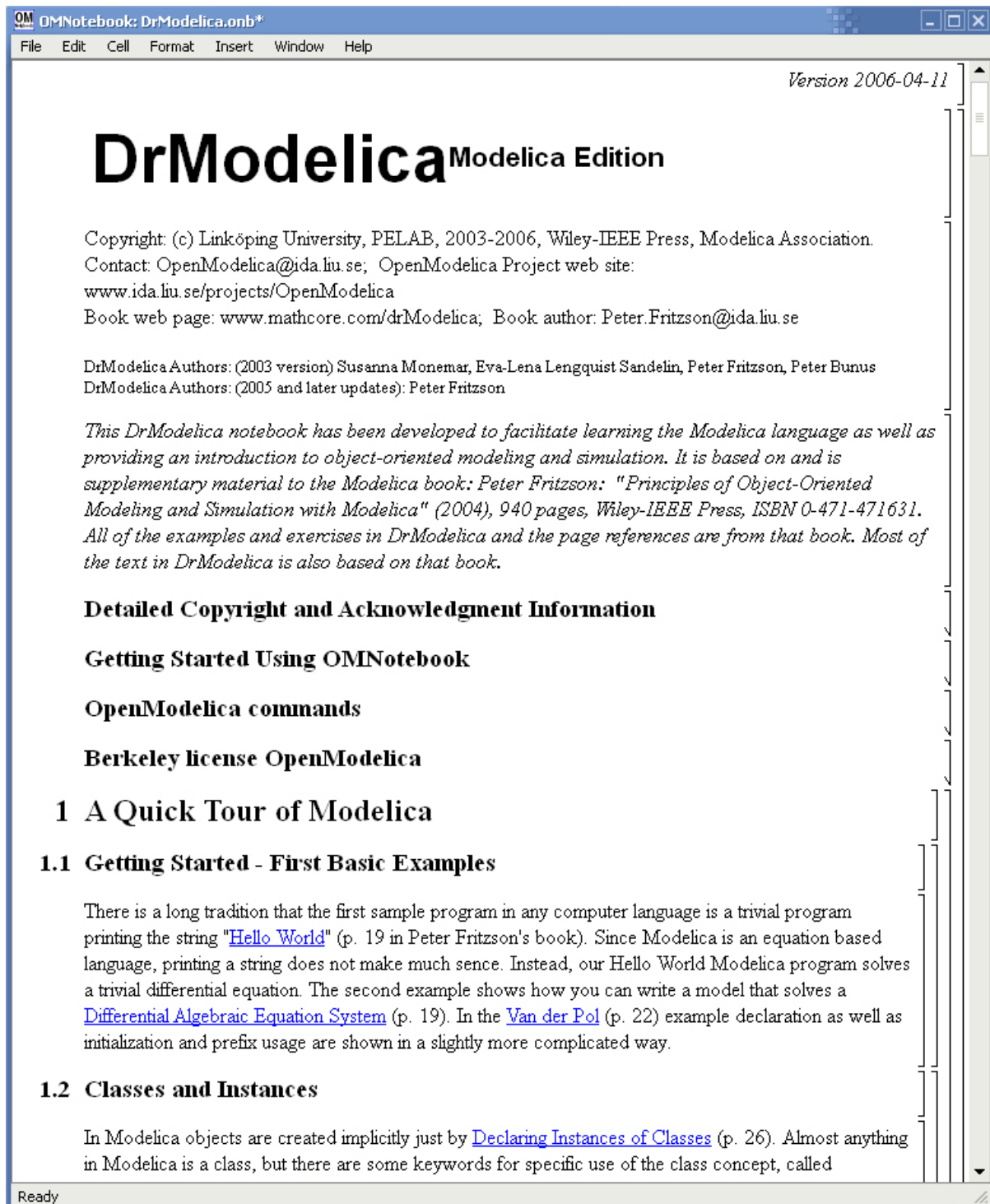

Figure 11.2: The front-page notebook of the OMNotebook version of the DrModelica tutoring system.

The screenshot shows the OMNotebook application window titled "OMNotebook: HelloWorld.onb". The interface includes a menu bar (File, Edit, Cell, Format, Insert, Window, Help) and a toolbar with various icons. The main content area is divided into sections:

First Basic Class

1 HelloWorld

The program contains a declaration of a class called `HelloWorld` with two fields and one equation. The first field is the variable `x` which is initialized to a start value `2` at the time when the simulation starts. The second field is the variable `a`, which is a constant that is initialized to `2` at the beginning of the simulation. Such a constant is prefixed by the keyword `parameter` in order to indicate that it is constant during simulation but is a model parameter that can be changed between simulations.

The Modelica program solves a trivial differential equation: $x' = -a * x$. The variable `x` is a state variable that can change value over time. The x' is the time derivative of `x`.

```
class HelloWorld
  Real x(start = 1, fixed=true);
  parameter Real a = 1;
equation
  der(x) = - a * x;
end HelloWorld;
```

{HelloWorld}

2 Simulation of HelloWorld

```
simulate( HelloWorld, startTime=0, stopTime=3 )

record SimulationResult
  resultFile = "HelloWorld_res.mat",
  messages = ""
end SimulationResult;
```

Plot the results.

```
plot( x )
```

[done]

Zoom Pan Auto Scale Fit in View Save Print Grid Detailed Grid No Grid Log X Log Y Setup

— x

Plot by OpenModelica

time	x
0.0	1.00
0.5	0.61
1.0	0.37
1.5	0.22
2.0	0.14
2.5	0.08
3.0	0.05
3.5	0.03
4.0	0.02

Ready

Figure 11.3: The HelloWorld class simulated and plotted using the OMNotebook version of DrModelica.

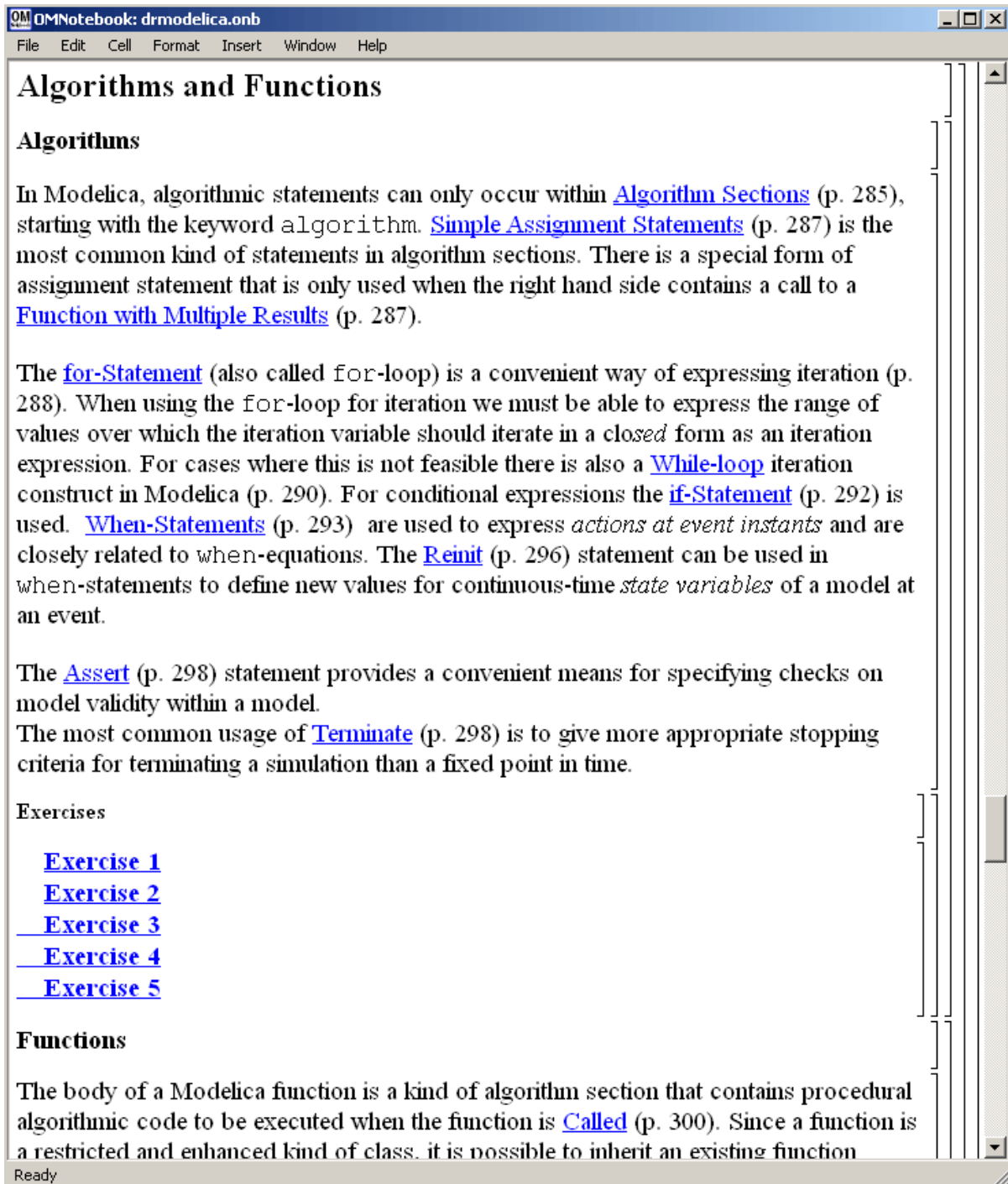

Figure 11.4: DrModelica Chapter on Algorithms and Functions in the main page of the OMNotebook version of DrModelica.

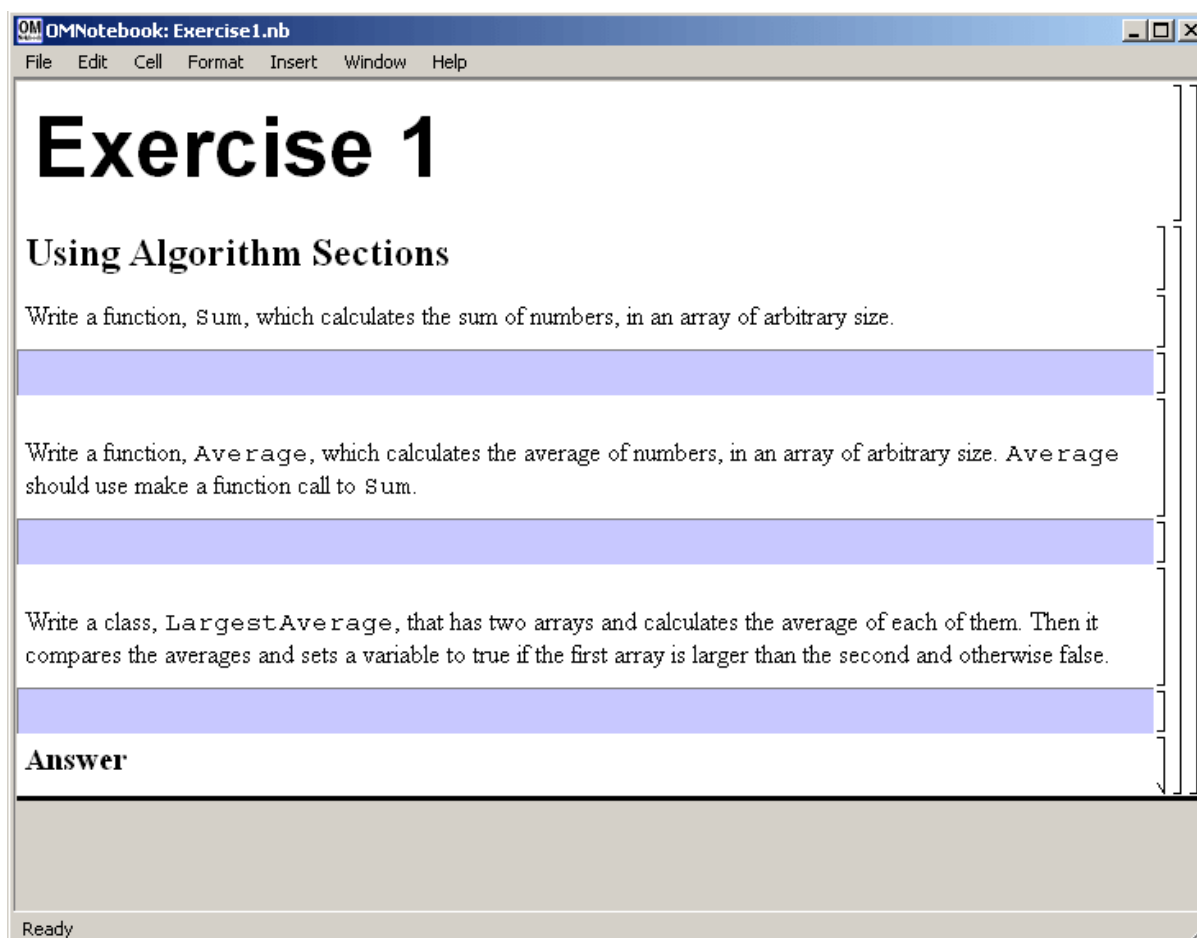

Figure 11.5: Exercise 1 in Chapter 9 of DrModelica.

Answer

Sum

```
function Sum
  input Real[:] x;
  output Real sum;
algorithm
  for i in 1:size(x,1) loop
    sum := sum + x[i];
  end for;
end Sum;
```

Average

```
function Average
  input Real[:] x;
  output Real average;
protected
  Real sum;
algorithm
  average := Sum(x) / size(x,1);
end Average;
```

LargestAverage

```
class LargestAverage
  parameter Integer[:] A1 = {1, 2, 3, 4, 5};
  parameter Integer[:] A2 = {7, 8, 9};
  Real averageA1, averageA2;
  Boolean A1Largest(start = false);
algorithm
  averageA1 := Average(A1);
  averageA2 := Average(A2);
  if averageA1 > averageA2 then
    A1Largest := true;
  else
    A1Largest := false;
  end if;
end LargestAverage;
```

Simulation of LargestAverage

```
simulate( LargestAverage );
```

When we look at the values in the variables we see that A2 has the largest average (8) and therefore the variable A1Largest is false (= 0).

Ready

Figure 11.6: The answer section to Exercise 1 in Chapter 9 of DrModelica.

11.3 DrControl Tutorial for Teaching Control Theory

DrControl is an interactive OMNotebook document aimed at teaching control theory. It is included in the OpenModelica distribution and appears under the directory:

```
>>> getInstallationDirectoryPath() + "/share/omnotebook/drcontrol"
"«OPENMODELICAHOME»/share/omnotebook/drcontrol"
```

The front-page of DrControl resembles a linked table of content that can be used as a navigation center. The content list contains topics like:

- Getting started
- The control problem in ordinary life
- Feedback loop
- Mathematical modeling
- Transfer function
- Stability
- Example of controlling a DC-motor
- Feedforward compensation
- State-space form
- State observation
- Closed loop control system.
- Reconstructed system
- Linear quadratic optimization
- Linearization

Each entry in this list leads to a new notebook page where either the theory is explained with Modelica examples or an exercise with a solution is provided to illustrate the background theory. Below we show a few sections of DrControl.

11.3.1 Feedback Loop

One of the basic concepts of control theory is using feedback loops either for neutralizing the disturbances from the surroundings or a desire for a smoother output.

In [Figure 11.7](#), control of a simple car model is illustrated where the car velocity on a road is controlled, first with an open loop control, and then compared to a closed loop system with a feedback loop. The car has a mass m , velocity y , and aerodynamic coefficient α . The ϑ is the road slope, which in this case can be regarded as noise.

Lets look at the Modelica model for the open loop controlled car:

$$m\dot{y} = u - \alpha y - mg * \sin(\theta)$$

```
model noFeedback
  import SI = Modelica.SIunits;
  SI.Velocity y; // output signal without noise,
  ↪theta = 0 -> v(t) = 0
  SI.Velocity yNoise; // output signal with noise,
  ↪theta <> 0 -> v(t) <> 0
  parameter SI.Mass m = 1500;
  parameter Real alpha = 200;
  parameter SI.Angle theta = 5*3.141592/180;
  parameter SI.Acceleration g = 9.82;
  SI.Force u;
```

(continues on next page)

File Edit Cell Format Insert Window Help



Feedback

One important method in designing control system is a feedback loop. It can be used to eliminate the influence of noise or to decrease the output error.

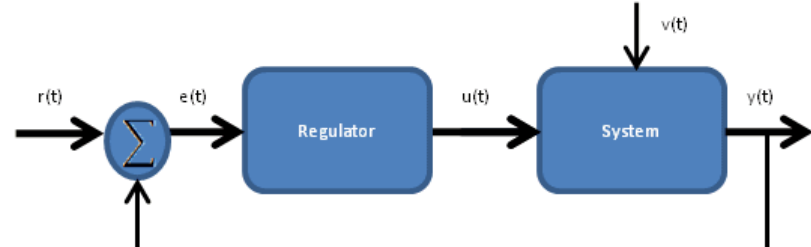

1 Example

Assume that we want to control the speed of a car on the road. The car has a mass m , velocity y , and aerodynamic coefficient α . The θ is the road slope, which in this case can be regarded as noise.

$$m\dot{y} = u - \alpha y - mg\sin(\theta)$$

If we want a reference speed of 20 m/s for a car with $m=1500$ kg, $\alpha=250$ Ns/m, $\theta=0$ rad, how high should the amplification factor be in the regulator?
Try with $u = 250*r$.

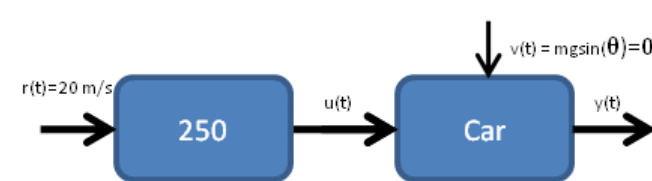

1.1 Open Loop

```

loadModel(Modelica)
true
model noFeedback
  import SI = Modelica.SIunits;
  SI.Velocity y; // output signal without
  noise, theta = 0 -> v(t) = 0 // output signal with noise
  SI.Velocity vNoise;

```

Figure 11.7: Feedback loop.

(continued from previous page)

```

SI.Velocity r=20;
equation
m*der(y)=u-alpha*y;           // signal without noise
m*der(yNoise)=u-alpha*yNoise-m*g*sin(theta); // with noise
u = 250*r;
end noFeedback;

```

By applying a road slope angle different from zero the car velocity is influenced which can be regarded as noise in this model. The output signal in [Figure 11.8](#) is stable but an overshoot can be observed compared to the reference signal. Naturally the overshoot is not desired and the student will in the next exercise learn how to get rid of this undesired behavior of the system.

```

>>> loadModel(Modelica)
true
>>> simulate(noFeedback, stopTime=100)
record SimulationResult
  resultFile = "«DOCHOME»/noFeedback_res.mat",
  simulationOptions = "startTime = 0.0, stopTime = 100.0, numberOfIntervals =
↳500, tolerance = 1e-06, method = 'dassl', fileNamePrefix = 'noFeedback', options_
↳= '', outputFormat = 'mat', variableFilter = '.*', cflags = '', simflags = '',
  messages = "LOG_SUCCESS      | info      | The initialization finished_
↳successfully without homotopy method.
LOG_SUCCESS      | info      | The simulation finished successfully.
",
  timeFrontend = 0.5826486749999999,
  timeBackend = 0.003792649,
  timeSimCode = 0.00188072,
  timeTemplates = 0.003684856,
  timeCompile = 0.404021621,
  timeSimulation = 0.016629465,
  timeTotal = 1.012775907
end SimulationResult;

```

Warning:

Warning: The initial conditions are not fully specified. For more information set `-d=initialization`. In OMEdit Tools->Options->Simulation->OMCFlags, in OMNotebook call `setCommandLineOptions("-d=initialization")`.

The closed car model with a proportional regulator is shown below:

$$u = K * (r - y)$$

```

model withFeedback
  import SI = Modelica.SIunits;
  SI.Velocity y;           // output signal with feedback_
↳link and without noise, theta = 0 -> v(t) = 0
  SI.Velocity yNoise;     // output signal with feedback_
↳link and noise,      theta <> 0 -> v(t) <> 0
  parameter SI.Mass m = 1500;
  parameter Real alpha = 250;
  parameter SI.Angle theta = 5*3.141592/180;
  parameter SI.Acceleration g = 9.82;
  SI.Force u;
  SI.Force uNoise;
  SI.Velocity r=20;
equation
m*der(y)=u-alpha*y;

```

(continues on next page)



Figure 11.8: Open loop control example.

(continued from previous page)

```

m*der(yNoise)=uNoise-alpha*yNoise-m*g*sin(theta);
u = 5000*(r-y);
uNoise = 5000*(r-yNoise);
end withFeedback;

```

By using the information about the current level of the output signal and re-tune the regulator the output quantity can be controlled towards the reference signal smoothly and without an overshoot, as shown in Figure 11.9.

In the above simple example the flat modeling approach was adopted since it was the fastest one to quickly obtain a working model. However, one could use the object oriented approach and encapsulate the car and regulator models in separate classes with the Modelica connector mechanism in between.

```

>>> loadModel(Modelica)
true
>>> simulate(withFeedback, stopTime=10)
record SimulationResult
  resultFile = "«DOCHOME»/withFeedback_res.mat",
  simulationOptions = "startTime = 0.0, stopTime = 10.0, numberOfIntervals = 500,
↳ tolerance = 1e-06, method = 'dassl', fileNamePrefix = 'withFeedback', options =
↳ ', outputFormat = 'mat', variableFilter = '.*', cflags = '', simflags = '',
  messages = "LOG_SUCCESS      | info      | The initialization finished_
↳ successfully without homotopy method.
LOG_SUCCESS      | info      | The simulation finished successfully.
",
  timeFrontend = 0.178681115,
  timeBackend = 0.002575254,
  timeSimCode = 0.000933793,
  timeTemplates = 0.002761303,
  timeCompile = 0.431170231,
  timeSimulation = 0.017448281,
  timeTotal = 0.6336714370000001
end SimulationResult;

```

Warning:

Warning: The initial conditions are not fully specified. For more information set `-d=initialization`. In OMEdit Tools->Options->Simulation->OMCFlags, in OMNotebook call `setCommandLineOptions("-`

```
d=initialization").
```

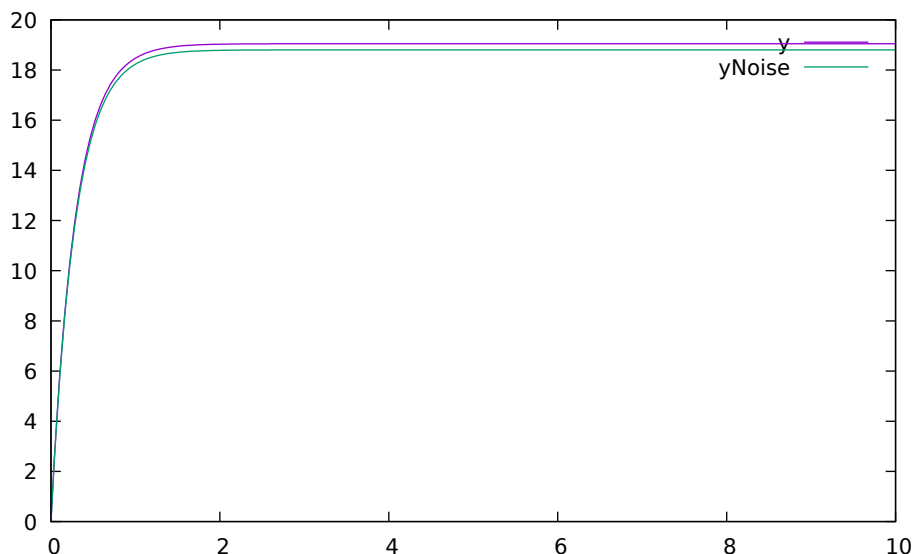

Figure 11.9: Closed loop control example.

11.3.2 Mathematical Modeling with Characteristic Equations

In most systems the relation between the inputs and outputs can be described by a linear differential equation. Tearing apart the solution of the differential equation into homogenous and particular parts is an important technique taught to the students in engineering courses, also illustrated in [Figure 11.10](#).

$$\frac{\partial^n y}{\partial t^n} + a_1 \frac{\partial^{n-1} y}{\partial t^{n-1}} + \dots + a_n y = b_0 \frac{\partial^m u}{\partial t^m} + \dots + b_{m-1} \frac{\partial u}{\partial t} + b_m u$$

Now let us examine a second order system:

$$\ddot{y} + a_1 \dot{y} + a_2 y = 1$$

```
model NegRoots
  Real y;
  Real der_y;
  parameter Real a1 = 3;
  parameter Real a2 = 2;
equation
  der_y = der(y);
  der(der_y) + a1*der_y + a2*y = 1;
end NegRoots;
```

Choosing different values for a_1 and a_2 leads to different behavior as shown in [Figure 11.11](#) and [Figure 11.12](#).

In the first example the values of a_1 and a_2 are chosen in such way that the characteristic equation has negative real roots and thereby a stable output response, see [Figure 11.11](#).

```
>>> simulate(NegRoots, stopTime=10)
record SimulationResult
  resultFile = "«DOCHOME»/NegRoots_res.mat",
  simulationOptions = "startTime = 0.0, stopTime = 10.0, numberOfIntervals = 500,
  ↪ tolerance = 1e-06, method = 'dassl', fileNamePrefix = 'NegRoots', options = '',
  ↪ outputFormat = 'mat', variableFilter = '.*', cflags = '', simflags = '',
```

(continues on next page)

File Edit Cell Format Insert Window Help

Mathematical Modeling

In most systems the relation between the inputs and outputs can be approximated by a linear differential equation.

$$\frac{d^n}{dt^n}y(t) + a_1 \frac{d^{n-1}}{dt^{n-1}}y(t) + \dots + a_n y(t) = b_0 \frac{d^m}{dt^m}u(t) + \dots + b_{m-1} \frac{d}{dt}u(t) + b_m u(t)$$

where the coefficients a_i and b_i are constants. The above differential equation has a homogeneous and a particular solution:

$$y = y_h + y_p$$

The homogeneous solution where u is set to zero has the form:

$$y_h = C_1 e^{\lambda_1 t} + \dots + C_n e^{\lambda_n t}$$

where

$$\lambda^n + a_1 \lambda^{n-1} + \dots + a_{n-1} \lambda + a_n = 0$$

1 Example

Consider the following model.

$$\frac{d^2}{dt^2}y(t) + a_1 \frac{d^1}{dt^1}y(t) + a_2 y(t) = 1$$

Examine the behavior of the system for different values on a_1 and a_2 .

1.1 Characteristic Equation with Negative Real Roots, $\lambda=-1,-2$

```

model negRoots
  Real y;
  Real der_y;
  parameter Real a1 = 3;
  parameter Real a2 = 2;
equation
  der_y = der(y);
  der(der_y) + a1*der_y + a2*y = 1;
end negRoots;
{negRoots}
simulate(negRoots.stopTime=10)

```

Figure 11.10: Mathematical modeling with characteristic equation.

(continued from previous page)

```

    messages = "LOG_SUCCESS      | info      | The initialization finished_
↳successfully without homotopy method.
LOG_SUCCESS      | info      | The simulation finished successfully.
",
    timeFrontend = 0.36422492,
    timeBackend = 0.001449301,
    timeSimCode = 0.00044324200000000001,
    timeTemplates = 0.00307956,
    timeCompile = 0.387237677,
    timeSimulation = 0.019817058,
    timeTotal = 0.776340395
end SimulationResult;

```

Warning:

Warning: The initial conditions are not fully specified. For more information set `-d=initialization`. In OMEdit Tools->Options->Simulation->OMCFlags, in OMNotebook call `setCommandLineOptions("-d=initialization")`.



Figure 11.11: Characteristic equation with real negative roots.

The importance of the sign of the roots in the characteristic equation is illustrated in Figure 11.11 and Figure 11.12, e.g., a stable system with negative real roots and an unstable system with positive imaginary roots resulting in oscillations.

```

model ImgPosRoots
  Real y;
  Real der_y;
  parameter Real a1 = -2;
  parameter Real a2 = 10;
equation
  der_y = der(y);
  der(der_y) + a1*der_y + a2*y = 1;
end ImgPosRoots;

```

```

>>> simulate(ImgPosRoots, stopTime=10)
record SimulationResult

```

(continues on next page)

(continued from previous page)

```

resultFile = "«DOCHOME»/ImgPosRoots_res.mat",
simulationOptions = "startTime = 0.0, stopTime = 10.0, numberOfIntervals = 500,
↳ tolerance = 1e-06, method = 'dassl', fileNamePrefix = 'ImgPosRoots', options = '
↳', outputFormat = 'mat', variableFilter = '.*', cflags = '', simflags = '',
messages = "LOG_SUCCESS      | info      | The initialization finished_
↳successfully without homotopy method.
LOG_SUCCESS      | info      | The simulation finished successfully.
",
timeFrontend = 0.36250379,
timeBackend = 0.001457165,
timeSimCode = 0.000440156,
timeTemplates = 0.002966178,
timeCompile = 0.419449971,
timeSimulation = 0.016107885,
timeTotal = 0.8030127309999999
end SimulationResult;

```

Warning:

Warning: The initial conditions are not fully specified. For more information set `-d=initialization`. In OMEdit Tools->Options->Simulation->OMCFlags, in OMNotebook call `setCommandLineOptions("-d=initialization")`.



Figure 11.12: Characteristic equation with imaginary roots with positive real part.

The theory and application of Kalman filters is also explained in the interactive course material.

In reality noise is present in almost every physical system under study and therefore the concept of noise is also introduced in the course material, which is purely Modelica based.

File Edit Cell Format Insert Window Help

loadModel(Modelica.Blocks)

1 Example

Consider a tank system with the following transfer function

$$G(s) = \frac{1}{A} \frac{1}{s + \frac{1}{T}}$$

What is the weight function? Can you plot the step response of the tank?

1.1 Tank Transfer Function

```

model Tank
  Modelica.Blocks.Continuous.TransferFunction G(b={1/A},
a={1,1/T},y_start(fixed=true)=1/A);
  Modelica.Blocks.Continuous.TransferFunction GStep(b={1/A}, a={1,1/T});
  parameter Real T = 15;
  parameter Real A = 5;
  Real u = if (time > 0 or time<0) then 0 else Modelica.Constants.inf;
  Real uStep = if (time > 0 or time<0) then 1 else 0;
  equation
  G.u = if time > 0 then 0 else 1e10;
  GStep.u = uStep;
end Tank;
{Tank}

```

```

simulate(Tank,startTime=-1e-10,numberOfIntervals=500,stopTime=10);
plot({G.y,GStep.y})
true

```

Plot by OpenModelica

Ready Ln 8, Col 1

Figure 11.13: Step and pulse (weight function) response.

1 **Kalman Filter**

Often we don't have access to the internal states of a system and can only measure the outputs of the system and have to reconstruct the state of the system based on these measurements. This is normally done with an [observer](#). The idea with an observer is that we feedback the difference of the measured output with the estimated output. If the estimation is correct then the difference should be zero.

Another difficulty is that the measured quantities often contain disturbance, i.e. noise.

$$\begin{cases} \dot{\hat{x}} = A\hat{x} + Bu + e \\ \hat{y} = C\hat{x} + v \end{cases}$$

Here e denoting a disturbance in the input signal and v is a measurement error. The quality of the estimate can be evaluated by the difference

$$K(y(t) - C\hat{x}(t) - Du(t))$$

By using this quantity as feedback we obtain the observer

$$\dot{\hat{x}} = A\hat{x}(t) + Bu(t) + K(y(t) - C\hat{x}(t) - Du(t))$$

Now form the error as

$$\tilde{x} = x - \hat{x}$$

The differential error is

Figure 11.14: Theory background about Kalman filter.

```

model KalmanFeedback
  parameter Real A[:,size(A, 1)] = {{0,1},{1,0}} ;
  parameter Real B[size(A, 1),:] = {{0},{1}};
  parameter Real C[:,size(A, 1)] = {{1,0}};
  parameter Real[2,1] K = [2.4;3.4];
  parameter Real[1,2] L = [2.4,3.4];
  parameter Real[:,:] ABL = A-B*L;
  parameter Real[:,:] BL = B*L;
  parameter Real[:,:] Z = zeros(size(ABL,2),size(AKC,1));
  parameter Real[:,:] AKC = A-K*C;
  parameter Real[:,:] Anew = [0,1,0,0 ; -1.4, -3.4, 2.4,3.4; 0,0,-2.4,1;0,0,-2.4,0];
  parameter Real[:,:] Bnew = [0;1;0;0];
  parameter Real[:,:] Fnew = [1;0;0;0];
  stateSpaceNoise Kalman(stateSpace.A=Anew,stateSpace.B=Bnew, stateSpace.C=[1,0,0,0],
stateSpace.F = Fnew);
  stateSpaceNoise noKalman;
end KalmanFeedback;

simulate(KalmanFeedback,stopTime=3)
plot({Kalman.stateSpace.y[1],noKalman.stateSpace.y[1]})
true

```

Plot by OpenModelica

Legend:

- Kalman.stateSpace.y[1]
- noKalman.stateSpace.y[1]

Figure 11.15: Comparison of a noisy system with feedback link in DrControl.

11.4 OpenModelica Notebook Commands

OMNotebook currently supports the commands and concepts that are described in this section.

11.4.1 Cells

Everything inside an OMNotebook document is made out of cells. A cell basically contains a chunk of data. That data can be text, images, or other cells. OMNotebook has four types of cells: headercell, textcell, inputcell, and groupcell. Cells are ordered in a tree structure, where one cell can be a parent to one or more additional cells. A tree view is available close to the right border in the notebook window to display the relation between the cells.

- **Textcell** – This cell type is used to display ordinary text and images. Each textcell has a style that specifies how text is displayed. The cell's style can be changed in the menu Format->Styles, example of different styles are: Text, Title, and Subtitle. The Textcell type also has support for following links to other notebook documents.
- **Inputcell** – This cell type has support for syntax highlighting and evaluation. It is intended to be used for writing program code, e.g. Modelica code. Evaluation is done by pressing the key combination Shift+Return or Shift+Enter. All the text in the cell is sent to OMC (OpenModelica Compiler/interpreter), where the text is evaluated and the result is displayed below the inputcell. By double-clicking on the cell marker in the tree view, the inputcell can be collapsed causing the result to be hidden.
- **Latexcell** – This cell type has support for evaluation of latex scripts. It is intended to be mainly used for writing mathematical equations and formulas for advanced documentation in OMNotebook. Each Latexcell supports a maximum of one page document output. To evaluate this cell, latex must be installed in your system. The users can copy and paste the latex scripts and start the evaluation. Evaluation is done by pressing the key combination Shift+Return or Shift+Enter or the green color eval button present in the toolbar. The script in the cell is sent to latex compiler, where it is evaluated and the output is displayed hiding the latex source. By double-clicking on the cell marker in the tree view, the latex source is displayed for further modification.
- **Groupcell** – This cell type is used to group together other cell. A groupcell can be opened or closed. When a groupcell is opened all the cells inside the groupcell are visible, but when the groupcell is closed only the first cell inside the groupcell is visible. The state of the groupcell is changed by the user double-clicking on the cell marker in the tree view. When the groupcell is closed the marker is changed and the marker has an arrow at the bottom.

11.4.2 Cursors

An OMNotebook document contains cells which in turn contain text. Thus, two kinds of cursors are needed for positioning, text cursor and cell cursor:

- **Textcursor** – A cursor between characters in a cell, appearing as a small vertical line. Position the cursor by clicking on the text or using the arrow buttons.
- **Cellcursor** – This cursor shows which cell currently has the input focus. It consists of two parts. The main cellcursor is basically just a thin black horizontal line below the cell with input focus. The cellcursor is positioned by clicking on a cell, clicking between cells, or using the menu item Cell->Next Cell or Cell->Previous Cell. The cursor can also be moved with the key combination Ctrl+Up or Ctrl+Down. The dynamic cellcursor is a short blinking horizontal line. To make this visible, you must click once more on the main cellcursor (the long horizontal line). NOTE: In order to paste cells at the cellcursor, the *dynamic cellcursor must be made active* by clicking on the main cellcursor (the horizontal line).

11.4.3 Selection of Text or Cells

To perform operations on text or cells we often need to select a range of characters or cells.

- **Select characters** – There are several ways of selecting characters, e.g. double-clicking on a word, clicking and dragging the mouse, or click followed by a shift-click at an adjacent position selects the text between the previous click and the position of the most recent shift-click.
- **Select cells** – Cells can be selected by clicking on them. Holding down Ctrl and clicking on the cell markers in the tree view allows several cells to be selected, one at a time. Several cells can be selected at once in the tree view by holding down the Shift key. Holding down Shift selects all cells between last selected cell and the cell clicked on. This only works if both cells belong to the same groupcell.

11.4.4 File Menu

The following file related operations are available in the file menu:

- **Create a new notebook** – A new notebook can be created using the menu File->New or the key combination Ctrl+N. A new document window will then open, with a new document inside.
- **Open a notebook** – To open a notebook use File->Open in the menu or the key combination Ctrl+O. Only files of the type .onb or .nb can be opened. If a file does not follow the OMNotebook format or the FullForm Mathematica Notebook format, a message box is displayed telling the user what is wrong. Mathematica Notebooks must be converted to fullform before they can be opened in OMNotebook.
- **Save a notebook** – To save a notebook use the menu item File->Save or File->Save As. If the notebook has not been saved before the save as dialog is shown and a filename can be selected. OMNotebook can only save in xml format and the saved file is not compatible with Mathematica. Key combination for save is Ctrl+S and for save as Ctrl+Shift+S. The saved file by default obtains the file extension .onb.
- **Print** – Printing a document to a printer is done by pressing the key combination Ctrl+P or using the menu item File->Print. A normal print dialog is displayed where the usually properties can be changed.
- **Import old document** – Old documents, saved with the old version of OMNotebook where a different file format was used, can be opened using the menu item File->Import->Old OMNotebook file. Old documents have the extension .xml.
- **Export text** – The text inside a document can be exported to a text document. The text is exported to this document without almost any structure saved. The only structure that is saved is the cell structure. Each paragraph in the text document will contain text from one cell. To use the export function, use menu item File->Export->Pure Text.
- **Close a notebook window** – A notebook window can be closed using the menu item File->Close or the key combination Ctrl+F4. Any unsaved changes in the document are lost when the notebook window is closed.
- **Quitting OMNotebook** – To quit OMNotebook, use menu item File->Quit or the key combination Ctrl+Q. This closes all notebook windows; users will have the option of closing OMC also. OMC will not automatically shutdown because other programs may still use it. Evaluating the command quit() has the same result as exiting OMNotebook.

11.4.5 Edit Menu

- **Editing cell text** – Cells have a set of of basic editing functions. The key combination for these are: Undo (Ctrl+Z), Redo (Ctrl+Y), Cut (Ctrl+X), Copy (Ctrl+C) and Paste (Ctrl+V). These functions can also be accessed from the edit menu; Undo (Edit->Undo), Redo (Edit->Redo), Cut (Edit->Cut), Copy (Edit->Copy) and Paste (Edit->Paste). Selection of text is done in the usual way by double-clicking, triple-clicking (select a paragraph), dragging the mouse, or using (Ctrl+A) to select all text within the cell.
- **Cut cell** – Cells can be cut from a document with the menu item Edit->Cut or the key combination Ctrl+X. The cut function will always cut cells if cells have been selected in the tree view, otherwise the cut function cuts text.
- **Copy cell** – Cells can be copied from a document with the menu item Edit->Copy or the key combination Ctrl+C. The copy function will always copy cells if cells have been selected in the tree view, otherwise the copy function copy text.
- **Paste cell** – To paste copied or cut cells the cell cursor must be selected in the location where the cells should be pasted. This is done by clicking on the cell cursor. Pasting cells is done from the menu Edit->Paste or the key combination Ctrl+V. If the cell cursor is selected the paste function will always paste cells. OMNotebook share the same application-wide clipboard. Therefore cells that have been copied from one document can be pasted into another document. Only pointers to the copied or cut cells are added to the clipboard, thus the cell that should be pasted must still exist. Consequently a cell can not be pasted from a document that has been closed.
- **Find** – Find text string in the current notebook, with the options match full word, match cell, search within closed cells. Short command Ctrl+F.
- **Replace** – Find and replace text string in the current notebook, with the options match full word, match cell, search+replace within closed cells. Short command Ctrl+H.
- **View expression** – Text in a cell is stored internally as a subset of HTML code and the menu item Edit->View Expression let the user switch between viewing the text or the internal HTML representation. Changes made to the HTML code will affect how the text is displayed.

11.4.6 Cell Menu

- **Add textcell** – A new textcell is added with the menu item Cell->Add Cell (previous cell style) or the key combination Alt+Enter. The new textcell gets the same style as the previous selected cell had.
- **Add inputcell** – A new inputcell is added with the menu item Cell->Add Inputcell or the key combination Ctrl+Shift+I.
- **Add latexcell** – A new latexcell is added with the menu item Cell->Add Latexcell or the key combination Ctrl+Shift+E.
- **Add groupcell** – A new groupcell is inserted with the menu item Cell->Groupcell or the key combination Ctrl+Shift+G. The selected cell will then become the first cell inside the groupcell.
- **Ungroup groupcell** – A groupcell can be ungrouped by selecting it in the tree view and using the menu item Cell->Ungroup Groupcell or by using the key combination Ctrl+Shift+U. Only one groupcell at a time can be ungrouped.
- **Split cell** – Splitting a cell is done with the menu item Cell->Split cell or the key combination Ctrl+Shift+P. The cell is splitted at the position of the text cursor.
- **Delete cell** – The menu item Cell->Delete Cell will delete all cells that have been selected in the tree view. If no cell is selected this action will delete the cell that have been selected by the cellcursor. This action can also be called with the key combination Ctrl+Shift+D or the key Del (only works when cells have been selected in the tree view).
- **Cellcursor** – This cell type is a special type that shows which cell that currently has the focus. The cell is basically just a thin black line. The cellcursor is moved by clicking on a cell or using the menu item Cell->Next Cell or Cell->Previous Cell. The cursor can also be moved with the key combination Ctrl+Up or Ctrl+Down.

11.4.7 Format Menu

- **Textcell** – This cell type is used to display ordinary text and images. Each textcell has a style that specifies how text is displayed. The cells style can be changed in the menu Format->Styles, examples of different styles are: Text, Title, and Subtitle. The Textcell type also have support for following links to other notebook documents.
- **Text manipulation** – There are a number of different text manipulations that can be done to change the appearance of the text. These manipulations include operations like: changing font, changing color and make text bold, but also operations like: changing the alignment of the text and the margin inside the cell. All text manipulations inside a cell can be done on single letters, words or the entire text. Text settings are found in the Format menu. The following text manipulations are available in OMNotebook:

- > Font family
- > Font face (Plain, Bold, Italic, Underline)
- > Font size
- > Font stretch
- > Font color
- > Text horizontal alignment
- > Text vertical alignment
- > Border thickness
- > Margin (outside the border)
- > Padding (inside the border)

11.4.8 Insert Menu

- **Insert image** – Images are added to a document with the menu item Insert->Image or the key combination Ctrl+Shift+M. After an image has been selected a dialog appears, where the size of the image can be chosen. The images actual size is the default value of the image. OMNotebook stretches the image accordantly to the selected size. All images are saved in the same file as the rest of the document.
- **Insert link** – A document can contain links to other OMNotebook file or Mathematica notebook and to add a new link a piece of text must first be selected. The selected text make up the part of the link that the user can click on. Inserting a link is done from the menu Insert->Link or with the key combination Ctrl+Shift+L. A dialog window, much like the one used to open documents, allows the user to choose the file that the link refers to. All links are saved in the document with a relative file path so documents that belong together easily can be moved from one place to another without the links failing.

11.4.9 Window Menu

- **Change window** – Each opened document has its own document window. To switch between those use the Window menu. The window menu lists all titles of the open documents, in the same order as they were opened. To switch to another document, simple click on the title of that document.

11.4.10 Help Menu

- **About OMNotebook** – Accessing the about message box for OMNotebook is done from the menu Help->About OMNotebook.
- **About Qt** – To access the message box for Qt, use the menu Help->About Qt.
- **Help Text** – Opening the help text (document OMNotebookHelp.onb) for OMNotebook can be done in the same way as any OMNotebook document is opened or with the menu Help->Help Text. The menu item can also be triggered with the key F1.

11.4.11 Additional Features

- **Links** – By clicking on a link, OMNotebook will open the document that is referred to in the link.
- **Update link** – All links are stored with relative file path. Therefore OMNotebook has functions that automatically updating links if a document is resaved in another folder. Every time a document is saved, OMNotebook checks if the document is saved in the same folder as last time. If the folder has changed, the links are updated.
- **Evaluate whole Notebook** – All the cells present in the Notebook can be evaluated in one step by pressing the red color evalall button in the toolbar. The cells are evaluated in the same order as they are in the Notebook. However the latex cells cannot be evaluated by this feature.
- **Evaluate several cells** – Several input cells can be evaluated at the same time by selecting them in the treeview and then pressing the key combination Shift+Enter or Shift+Return. The cells are evaluated in the same order as they have been selected. If a group cell is selected all input cells in that group cell are evaluated, in the order they are located in the group cell.
- **Moving and Reordering cells in a Notebook** – It is possible to shift cells to a new position and change the hierarchical order of the document. This can be done by clicking the cell and press the Up and Down arrow button in the tool bar to move either Up or Down. The cells are moved one cell above or below. It is also possible to move a cell directly to a new position with one single click by pressing the red color bidirectional UpDown arrow button in the toolbar. To do this the user has to place the cell cursor to a position where the selected cells must be moved. After selecting the cell cursor position, select the cells you want to shift and press the bidirectional UpDown arrow button. The cells are shifted in the same order as they are selected. This is especially very useful when shifting a group cell.
- **Command completion** – Input cells have command completion support, which checks if the user is typing a command (or any keyword defined in the file commands.xml) and finish the command. If the user types the first two or three letters in a command, the command completion function fills in the rest. To use command completion, press the key combination Ctrl+Space or Shift+Tab. The first command that matches the letters written will then appear. Holding down Shift and pressing Tab (alternative holding down Ctrl and pressing Space) again will display the second command that matches. Repeated request to use command completion will loop through all commands that match the letters written. When a command is displayed by the command completion functionality any field inside the command that should be edited by the user is automatically selected. Some commands can have several of these fields and by pressing the key combination Ctrl+Tab, the next field will be selected inside the command. > Active Command completion: Ctrl+Space / Shift+Tab > Next command: Ctrl+Space / Shift+Tab > Next field in command: Ctrl+Tab'
- **Generated plot** – When plotting a simulation result, OMC uses the program Ptpplot to create a plot. From Ptpplot OMNotebook gets an image of the plot and automatically adds that image to the output part of an input cell. Like all other images in a document, the plot is saved in the document file when the document is saved.
- **Stylesheet** – OMNotebook follows the style settings defined in stylesheet.xml and the correct style is applied to a cell when the cell is created.
- **Automatic Chapter Numbering** – OMNotebook automatically numbers different chapter, subchapter, section and other styles. The user can specify which styles should have chapter numbers and which

level the style should have. This is done in the stylesheet.xml file. Every style can have a <chapter-Level> tag that specifies the chapter level. Level 0 or no tag at all, means that the style should not have any chapter numbering.

- **Scrollarea – Scrolling through a document can be done by using the** mouse wheel. A document can also be scrolled by moving the cell cursor up or down.
- **Syntax highlighter – The syntax highlighter runs in a separated** thread which speeds up the loading of large document that contains many Modelica code cells. The syntax highlighter only highlights when letters are added, not when they are removed. The color settings for the different types of keywords are stored in the file modelicacolors.xml. Besides defining the text color and background color of keywords, whether or not the keywords should be bold or/and italic can be defined.
- **Change indicator – A star (*) will appear behind the filename in** the title of notebook window if the document has been changed and needs saving. When the user closes a document that has some unsaved change, OMNotebook asks the user if he/she wants to save the document before closing. If the document never has been saved before, the save-as dialog appears so that a filename can be chosen for the new document.
- **Update menus – All menus are constantly updated so that only menu** items that are linked to actions that can be performed on the currently selected cell is enabled. All other menu items will be disabled. When a textcell is selected the Format menu is updated so that it indicates the text settings for the text, in the current cursor position.

11.5 References

Todo: Add these into extrarefs.bib and cite them somewhere

Eric Allen, Robert Cartwright, Brian Stoler. DrJava: A lightweight pedagogic environment for Java. In Proceedings of the 33rd ACM Technical Symposium on Computer Science Education (SIGCSE 2002) (Northern Kentucky – The Southern Side of Cincinnati, USA, February 27 – March 3, 2002).

Anders Fernström, Ingemar Axelsson, Peter Fritzson, Anders Sandholm, Adrian Pop. OMNotebook – Interactive WYSIWYG Book Software for Teaching Programming. In Proc. of the Workshop on Developing Computer Science Education – How Can It Be Done?. Linköping University, Dept. Computer & Inf. Science, Linköping, Sweden, March 10, 2006.

Eva-Lena Lengquist-Sandelin, Susanna Monemar, Peter Fritzson, and Peter Bunus. DrModelica – A Web-Based Teaching Environment for Modelica. In Proceedings of the 44th Scandinavian Conference on Simulation and Modeling (SIMS'2003), available at www.scan-sims.org. Västerås, Sweden. September 18-19, 2003.

OPTIMIZATION WITH OPENMODELICA

The following facilities for model-based optimization are provided with OpenModelica:

- **Builtin Dynamic Optimization with OpenModelica and IpOpt using** dynamic optimization is the recommended way of performing dynamic optimization with OpenModelica.
- **Dynamic Optimization with OpenModelica and CasADi.** Use this if you want to employ the CasADi tool for dynamic optimization.
- **Classical Parameter Sweep Optimization using OMOptim.** Use this if you have a static optimization problem.

12.1 Builtin Dynamic Optimization with OpenModelica and IpOpt

Note: this is a very short preliminary description which soon will be considerably improved.

OpenModelica provides builtin dynamic optimization of models by using the powerful symbolic machinery of the OpenModelica compiler for more efficient and automatic solution of dynamic optimization problems.

The builtin dynamic optimization allows users to define optimal control problems (OCP) using the Modelica language for the model and the optimization language extension called Optimica (currently partially supported) for the optimization part of the problem. This is used to solve the underlying dynamic optimization model formulation using collocation methods, using a single execution instead of multiple simulations as in the parameter-sweep optimization described in section *Parameter Sweep Optimization using OMOptim*.

For more detailed information regarding background and methods, see [BOR+12][RBB+14]

12.2 Compiling the Modelica code

Before starting the optimization the model should be symbolically instantiated by the compiler in order to get a single flat system of equations. The model variables should also be scalarized. The compiler frontend performs this, including syntax checking, semantics and type checking, simplification and constant evaluation etc. are applied. Then the complete flattened model can be used for initialization, simulation and last but not least for model-based dynamic optimization.

The OpenModelica command `optimize(ModelName)` from OMSHELL, OMNotebook or MDT runs immediately the optimization. The generated result file can be read in and visualized with OMEdit or within OMNotebook.

12.3 An Example

In this section, a simple optimal control problem will be solved. When formulating the optimization problems, models are expressed in the Modelica language and optimization specifications. The optimization language specification allows users to formulate dynamic optimization problems to be solved by a numerical algorithm. It includes several constructs including a new specialized class optimization, a constraint section, startTime, finalTime etc. See the optimal control problem for batch reactor model below.

Create a new file named *BatchReactor.mo* and save it in your working directory. Notice that this model contains both the dynamic system to be optimized and the optimization specification.

Once we have formulated the underlying optimal control problems, we can run the optimization by using OMSHELL, OMNotebook, MDT, OMEdit using command line terminals similar to the options described below:

```
>>> setCommandLineOptions("-g=Optimica");
```

Listing 12.1: BatchReactor.mo

```
model BatchReactor
  Real x1(start =1, fixed=true, min=0, max=1);
  Real x2(start =0, fixed=true, min=0, max=1);
  input Real u(min=0, max=5);
equation
  der(x1) = -(u+u^2/2)*x1;
  der(x2) = u*x1;
end BatchReactor;
```

```
optimization nmpcBatchReactor(objective=-x2)
  extends BatchReactor;
end nmpcBatchReactor;
```

```
>>> optimize(nmpcBatchReactor, numberOfIntervals=16, stopTime=1, tolerance=1e-8)
record SimulationResult
  resultFile = "«DOCHOME»/nmpcBatchReactor_res.mat",
  simulationOptions = "startTime = 0.0, stopTime = 1.0, numberOfIntervals = 16,
↳ tolerance = 1e-08, method = 'optimization', fileNamePrefix = 'nmpcBatchReactor',
↳ options = '', outputFormat = 'mat', variableFilter = '.*', cflags = '', simflags
↳ = '',
  messages = "LOG_SUCCESS      | info      | The initialization finished
↳ successfully without homotopy method.

Optimizer Variables
=====
State[0]:x1(start = 1, nominal = 1, min = 0, max = 1, init = 1)
State[1]:x2(start = 0, nominal = 1, min = 0, max = 1, init = 0)
Input[2]:u(start = 0, nominal = 5, min = 0, max = 5)
-----
number of nonlinear constraints: 0
=====

*****
This program contains Ipopt, a library for large-scale nonlinear optimization.
Ipopt is released as open source code under the Eclipse Public License (EPL).
For more information visit http://projects.coin-or.org/Ipopt
*****

LOG_SUCCESS      | info      | The simulation finished successfully.
",
  timeFrontend = 0.157751207,
  timeBackend = 0.0064304,
  timeSimCode = 0.00139588,
```

(continues on next page)

(continued from previous page)

```
timeTemplates = 0.0043086980000000001,  
timeCompile = 0.421807787,  
timeSimulation = 0.034628981,  
timeTotal = 0.626441977  
end SimulationResult;
```

The control and state trajectories of the optimization results:

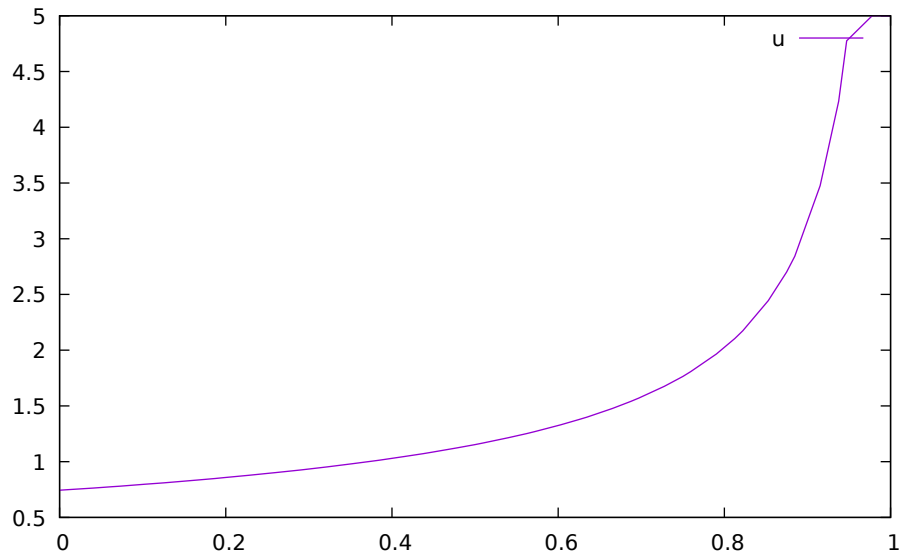

Figure 12.1: Optimization results for Batch Reactor model – input variables.

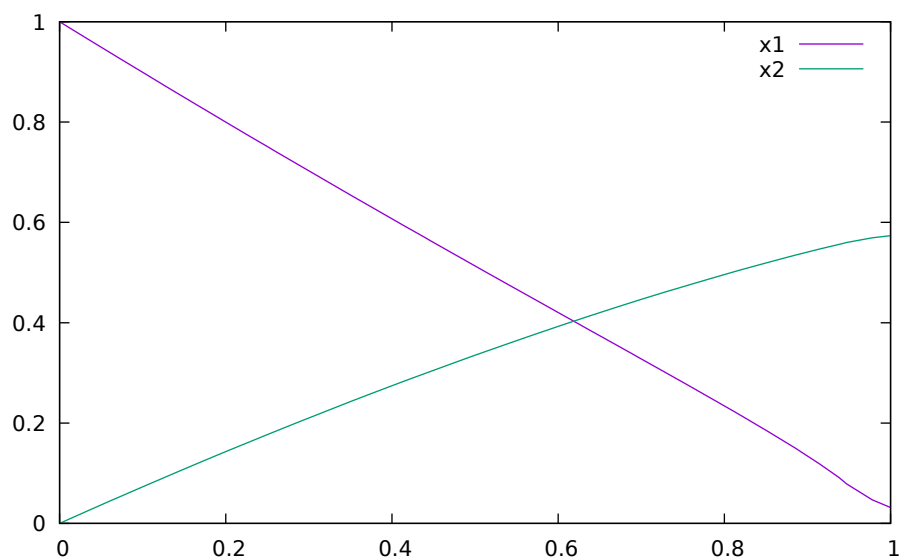

Figure 12.2: Optimization results for Batch Reactor model – state variables.

12.4 Different Options for the Optimizer IPOPT

Table 12.1: New meanings of the usual simulation options for Ipopt.

numberOfIntervals		collocation intervals
startTime, stopTime		time horizon
tolerance = 1e-8	e.g. 1e-8	solver tolerance
simflags	all run/debug options	

Table 12.2: New simulation options for Ipopt.

-lv	LOG_IPOPT	console output
-ipopt_hesse	CONST,BFGS,NUM	hessian approximation
-ipopt_max_iter	number e.g. 10	maximal number of iteration for ipopt
externalInput.csv		input guess

12.5 Dynamic Optimization with OpenModelica and CasADi

OpenModelica coupling with CasADi supports dynamic optimization of models by OpenModelica exporting the optimization problem to CasADi which performs the optimization. In order to convey the dynamic system model information between Modelica and CasADi, we use an XML-based model exchange format for differential-algebraic equations (DAE). OpenModelica supports export of models written in Modelica and the Optimization language extension using this XML format, while CasADi supports import of models represented in this format. This allows users to define optimal control problems (OCP) using Modelica and Optimization language specifications, and solve the underlying model formulation using a range of optimization methods, including direct collocation and direct multiple shooting.

12.5.1 Compiling the Modelica code

Before exporting a model to XML, the model should be symbolically instantiated by the compiler in order to get a single flat system of equations. The model variables should also be scalarized. The compiler frontend performs this, including syntax checking, semantics and type checking, simplification and constant evaluation etc. are applied. Then the complete flattened model is exported to XML code. The exported XML document can then be imported to CasADi for model-based dynamic optimization.

The OpenModelica command `translateModelXML(ModelName)` from OMSHELL, OMNotebook or MDT exports the XML. The export XML command is also integrated with OMEdit. Select XML > Export XML the XML document is generated in the current directory of omc. You can use the `cd()` command to see the current location. After the command execution is complete you will see that a file `ModelName.xml` has been exported.

Assuming that the model is defined in the `modelName.mo`, the model can also be exported to an XML code using the following steps from the terminal window:

- Go to the path where your model file found
- Run command `omc -g=Optimica --simCodeTarget=XML Model.mo`

12.5.2 An example

In this section, a simple optimal control problem will be solved. When formulating the optimization problems, models are expressed in the Modelica language and optimization specifications. The optimization language specification allows users to formulate dynamic optimization problems to be solved by a numerical algorithm. It includes several constructs including a new specialized class optimization, a constraint section, startTime, finalTime etc. See the optimal control problem for batch reactor model below.

Create a new file named *BatchReactor.mo* and save it in your working directory. Notice that this model contains both the dynamic system to be optimized and the optimization specification.

```
>>> list (BatchReactor)
model BatchReactor
  Real x1(start = 1, fixed = true, min = 0, max = 1);
  Real x2(start = 0, fixed = true, min = 0, max = 1);
  input Real u(min = 0, max = 5);
equation
  der(x1) = -(u + u ^ 2 / 2) * x1;
  der(x2) = u * x1;
end BatchReactor;
```

Once we have formulated the underlying optimal control problems, we can export the XML by using OMSHELL, OMNotebook, MDT, OMEdit or command line terminals which are described in Section *XML Import to CasADi via OpenModelica Python Script*.

To export XML, we set the simulation target to XML:

```
>>> translateModelXML (BatchReactor)
"«DOCHOME»/BatchReactor.xml"
```

This will generate an XML file named *BatchReactor.xml* (Listing 12.2) that contains a symbolic representation of the optimal control problem and can be inspected in a standard XML editor.

Listing 12.2: BatchReactor.xml

```
<?xml version="1.0" encoding="UTF-8"?>
<OpenModelicaModelDescription
  xmlns:exp="https://svn.jmodelica.org/trunk/XML/daeExpressions.xsd"
  xmlns:equ="https://svn.jmodelica.org/trunk/XML/daeEquations.xsd"
  xmlns:fun="https://svn.jmodelica.org/trunk/XML/daeFunctions.xsd"
  xmlns:opt="https://svn.jmodelica.org/trunk/XML/daeOptimization.xsd"
  xmlns:xsi="http://www.w3.org/2001/XMLSchema-instance"
  fmiVersion="1.0"
  modelName="BatchReactor"
  modelIdentifier="BatchReactor"
  guid="{20f861e9-ffe2-45b2-9ef7-791c1f6158b0}"
  generationDateAndTime="2020-10-14T07:09:49"
  variableNamingConvention="structured"
  numberOfContinuousStates="2"
  numberOfEventIndicators="0"
  >
  <VendorAnnotations>
    <Tool name="OpenModelica Compiler OMCompiler v1.16.0-dev.beta3.22+gfeadc57b32">
    </Tool>
  </VendorAnnotations>
  <ModelVariables>
    <ScalarVariable name="x1" valueReference="0" variability="continuous"
    causality="internal" alias="noAlias">
      <Real start="1.0" fixed="true" min="0.0" max="1.0" />
    <QualifiedName>
```

(continues on next page)

(continued from previous page)

```

    <exp:QualifiedNamePart name="x1"/>
  </QualifiedName>
<isLinearTimedVariables>
  <TimePoint index="0" isLinear="true"/>
</isLinearTimedVariables>
  <VariableCategory>state</VariableCategory>
</ScalarVariable>

  <ScalarVariable name="x2" valueReference="1" variability="continuous"
↳causality="internal" alias="noAlias">
    <Real start="0.0" fixed="true" min="0.0" max="1.0" />
    <QualifiedName>
      <exp:QualifiedNamePart name="x2"/>
    </QualifiedName>
    <isLinearTimedVariables>
      <TimePoint index="0" isLinear="true"/>
    </isLinearTimedVariables>
    <VariableCategory>state</VariableCategory>
  </ScalarVariable>
  <ScalarVariable name="der(x1)" valueReference="2" variability="continuous"
↳causality="internal" alias="noAlias">
    <Real />
    <QualifiedName>
      <exp:QualifiedNamePart name="x1"/>
    </QualifiedName>
    <isLinearTimedVariables>
      <TimePoint index="0" isLinear="true"/>
    </isLinearTimedVariables>
    <VariableCategory>derivative</VariableCategory>
  </ScalarVariable>

  <ScalarVariable name="der(x2)" valueReference="3" variability="continuous"
↳causality="internal" alias="noAlias">
    <Real />
    <QualifiedName>
      <exp:QualifiedNamePart name="x2"/>
    </QualifiedName>
    <isLinearTimedVariables>
      <TimePoint index="0" isLinear="true"/>
    </isLinearTimedVariables>
    <VariableCategory>derivative</VariableCategory>
  </ScalarVariable>
  <ScalarVariable name="u" valueReference="4" variability="continuous"
↳causality="input" alias="noAlias">
    <Real min="0.0" max="5.0" />
    <QualifiedName>
      <exp:QualifiedNamePart name="u"/>
    </QualifiedName>
    <isLinearTimedVariables>
      <TimePoint index="0" isLinear="true"/>
    </isLinearTimedVariables>
    <VariableCategory>algebraic</VariableCategory>
  </ScalarVariable>
</ModelVariables>

<equ:BindingEquations>
</equ:BindingEquations>

<equ:DynamicEquations>
  <equ:Equation>
    <exp:Sub>

```

(continues on next page)

(continued from previous page)

```

    <exp:Der>
      <exp:Identifier>
        <exp:QualifiedNamePart name="x2"/>
      </exp:Identifier>
    </exp:Der>
  </exp:Mul>
</exp:Sub>
</equ:Equation>
<equ:Equation>
  <exp:Sub>
    <exp:Der>
      <exp:Identifier>
        <exp:QualifiedNamePart name="x1"/>
      </exp:Identifier>
    </exp:Der>
    <exp:Mul>
      <exp:Sub>
        <exp:Mul>
          <exp:RealLiteral>-0.5</exp:RealLiteral>
          <exp:Pow>
            <exp:Identifier>
              <exp:QualifiedNamePart name="u"/>
            </exp:Identifier>
            <exp:RealLiteral>2.0</exp:RealLiteral>
          </exp:Pow>
        </exp:Mul>
        <exp:Identifier>
          <exp:QualifiedNamePart name="u"/>
        </exp:Identifier>
      </exp:Sub>
      <exp:Identifier>
        <exp:QualifiedNamePart name="x1"/>
      </exp:Identifier>
    </exp:Mul>
  </exp:Sub>
</equ:Equation>
</equ:DynamicEquations>

<equ:InitialEquations>
  <equ:Equation>
    <exp:Sub>
      <exp:Identifier>
        <exp:QualifiedNamePart name="x1"/>
      </exp:Identifier>
      <exp:RealLiteral>1.0</exp:RealLiteral>
    </exp:Sub>
  </equ:Equation>

  <equ:Equation>
    <exp:Sub>
      <exp:Identifier>
        <exp:QualifiedNamePart name="x2"/>
      </exp:Identifier>
      <exp:RealLiteral>0.0</exp:RealLiteral>
    </exp:Sub>
  </equ:Equation>

```

(continues on next page)

```

</exp:Sub>
</equ:Equation>
<equ:Equation>
  <exp:Sub>
    <exp:Identifier>
      <exp:QualifiedNamePart name="x1"/>
    </exp:Identifier>
    <exp:Identifier>
      <exp:QualifiedNamePart name="$START"/>
      <exp:QualifiedNamePart name="x1"/>
    </exp:Identifier>
  </exp:Sub>
</equ:Equation>
<equ:Equation>
  <exp:Sub>

  </exp:Sub>
</equ:Equation>
<equ:Equation>
  <exp:Sub>

  </exp:Sub>
</equ:Equation>
<equ:Equation>
  <exp:Sub>
    <exp:Identifier>
      <exp:QualifiedNamePart name="x2"/>
    </exp:Identifier>
    <exp:Identifier>
      <exp:QualifiedNamePart name="$START"/>
      <exp:QualifiedNamePart name="x2"/>
    </exp:Identifier>
  </exp:Sub>
</equ:Equation>
</equ:InitialEquations>

<fun:Algorithm>
</fun:Algorithm>

<fun:RecordsList>
</fun:RecordsList>

<fun:FunctionsList>
</fun:FunctionsList>

<opt:Optimization>
  <opt:TimePoints>
    <opt:TimePoint >
    </opt:TimePoint>
  </opt:TimePoints>
  <opt:PathConstraints>
  </opt:PathConstraints>
</opt:Optimization>

</OpenModelicaModelDescription>

```

12.5.3 XML Import to CasADi via OpenModelica Python Script

The symbolic optimal control problem representation (or just model description) contained in BatchReactor.xml can be imported into CasADi in the form of the SymbolicOCP class via OpenModelica python script.

The SymbolicOCP class contains symbolic representation of the optimal control problem designed to be general and allow manipulation. For a more detailed description of this class and its functionalities, we refer to the API documentation of CasADi.

The following step compiles the model to an XML format, imports to CasADi and solves an optimization problem in windows PowerShell:

1. Create a new file named BatchReactor.mo and save it in you working directory.

E.g. C:\OpenModelica1.9.2\share\casadi\testmodel

1. Perform compilation and generate the XML file

- a. Go to your working directory

E.g. cd C:\OpenModelica1.9.2\share\casadi\testmodel

- a. Go to omc path from working directory and run the following command

E.g. ..\..\bin\omc +s -g=Optimica --simCodeTarget=XML BatchReactor.mo

3. Run defaultStart.py python script from OpenModelica optimization directory

E.g. Python.exe ..\share\casadi\scripts defaultStart.py BatchReactor.xml

The control and state trajectories of the optimization results are shown below:



12.6 Parameter Sweep Optimization using OMOptim

OMOptim is a tool for parameter sweep design optimization of Modelica models. By optimization, one should understand a procedure which minimizes/maximizes one or more objective functions by adjusting one or more parameters. This is done by the optimization algorithm performing a parameter sweep, i.e., systematically adjusting values of selected parameters and running a number of simulations for different parameter combinations to find a parameter setting that gives an optimal value of the goal function.

OMOptim 0.9 contains meta-heuristic optimization algorithms which allow optimizing all sorts of models with following functionalities:

- One or several objectives optimized simultaneously
- One or several parameters (integer or real variables)

However, the user must be aware of the large number of simulations an optimization might require.

12.6.1 Preparing the Model

Before launching OMOptim, one must prepare the model in order to optimize it.

Parameters

An optimization parameter is picked up from all model variables. The choice of parameters can be done using the OMOptim interface.

For all intended parameters, please note that:

- **The corresponding variable is constant during all simulations.** The OMOptim optimization in version 0.9 only concerns static parameters' optimization *i.e.* values found for these parameters will be constant during all simulation time.
- **The corresponding variable should play an input role in the model** *i.e.* its modification influences model simulation results.

Constraints

If some constraints should be respected during optimization, they must be defined in the Modelica model itself.

For instance, if mechanical stress must be less than 5 N.m⁻², one should write in the model:

```
assert(mechanicalStress < 5, "Mechanical stress too high");
```

If during simulation, the variable *mechanicalStress* exceeds 5 N.m⁻², the simulation will stop and be considered as a failure.

Objectives

As parameters, objectives are picked up from model variables. Objectives' values are considered by the optimizer at the *final time*.

12.6.2 Set problem in OMOptim

Launch OMOptim

OMOptim can be launched using the executable placed in OpenModelicaInstallationDirectory/bin/ OMOptim/OMOptim.exe. Alternately, choose OpenModelica > OMOptim from the start menu.

Create a new project

To create a new project, click on menu File -> New project

Then set a name to the project and save it in a dedicated folder. The created file created has a .min extension. It will contain information regarding model, problems, and results loaded.

Load models

First, you need to load the model(s) you want to optimize. To do so, click on *Add .mo* button on main window or select menu *Model -> Load Mo file...*

When selecting a model, the file will be loaded in OpenModelica which runs in the background.

While OpenModelica is loading the model, you could have a frozen interface. This is due to multi-threading limitation but the delay should be short (few seconds).

You can load as many models as you want.

If an error occurs (indicated in log window), this might be because:

- Dependencies have not been loaded before (e.g. modelica library)
- Model use syntax incompatible with OpenModelica.

Dependencies

OMOptim should detect dependencies and load corresponding files. However, if some errors occur, please load by yourself dependencies. You can also load Modelica library using *Model->Load Modelica library*.

When the model correctly loaded, you should see a window similar to Figure 12.3.

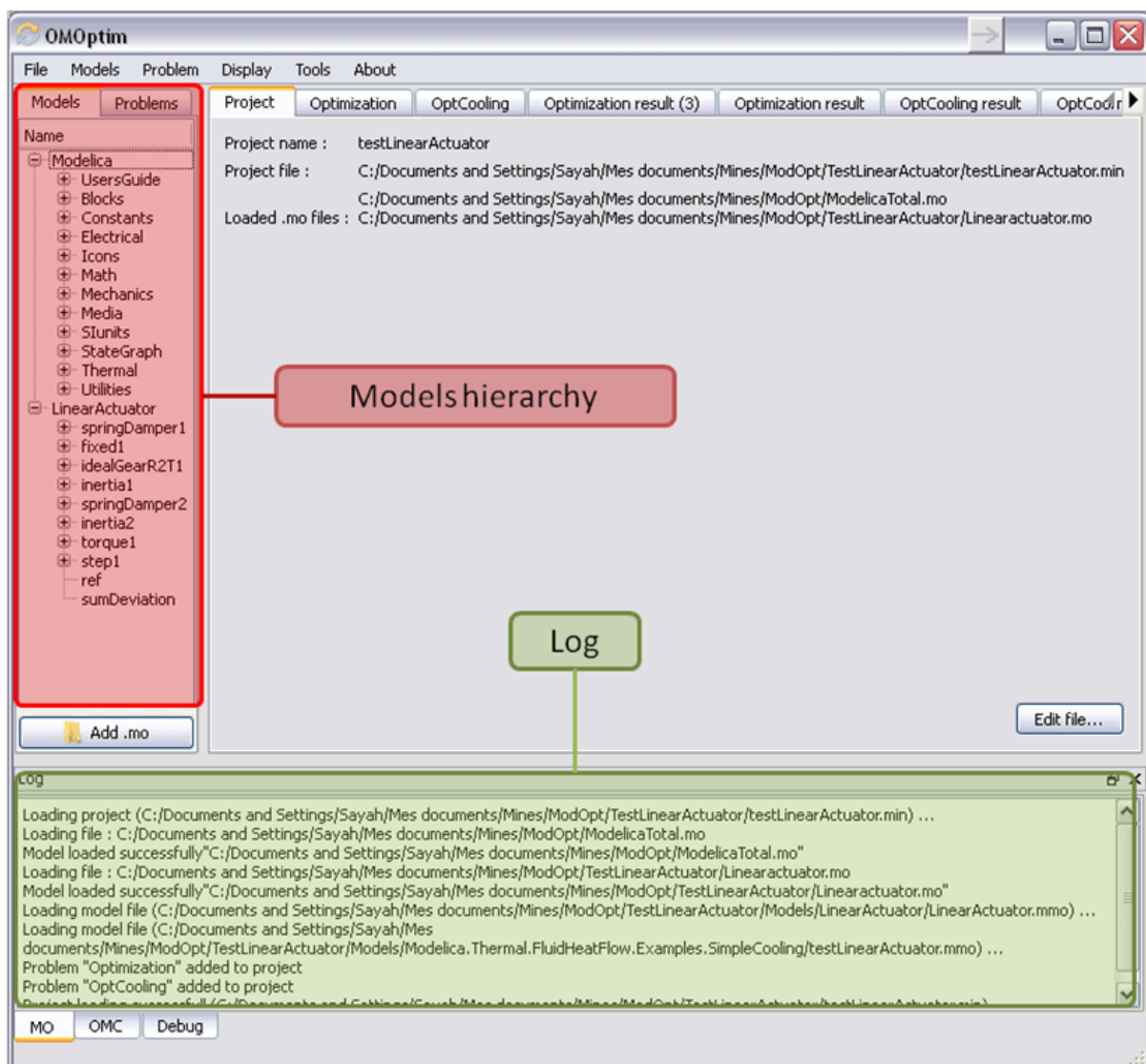

Figure 12.3: OMOptim window after having loaded model.

Create a new optimization problem

Problem->Add Problem->Optimization

A dialog should appear. Select the model you want to optimize. Only Model can be selected (no Package, Component, Block...).

A new form will be displayed. This form has two tabs. One is called Variables, the other is called Optimization.

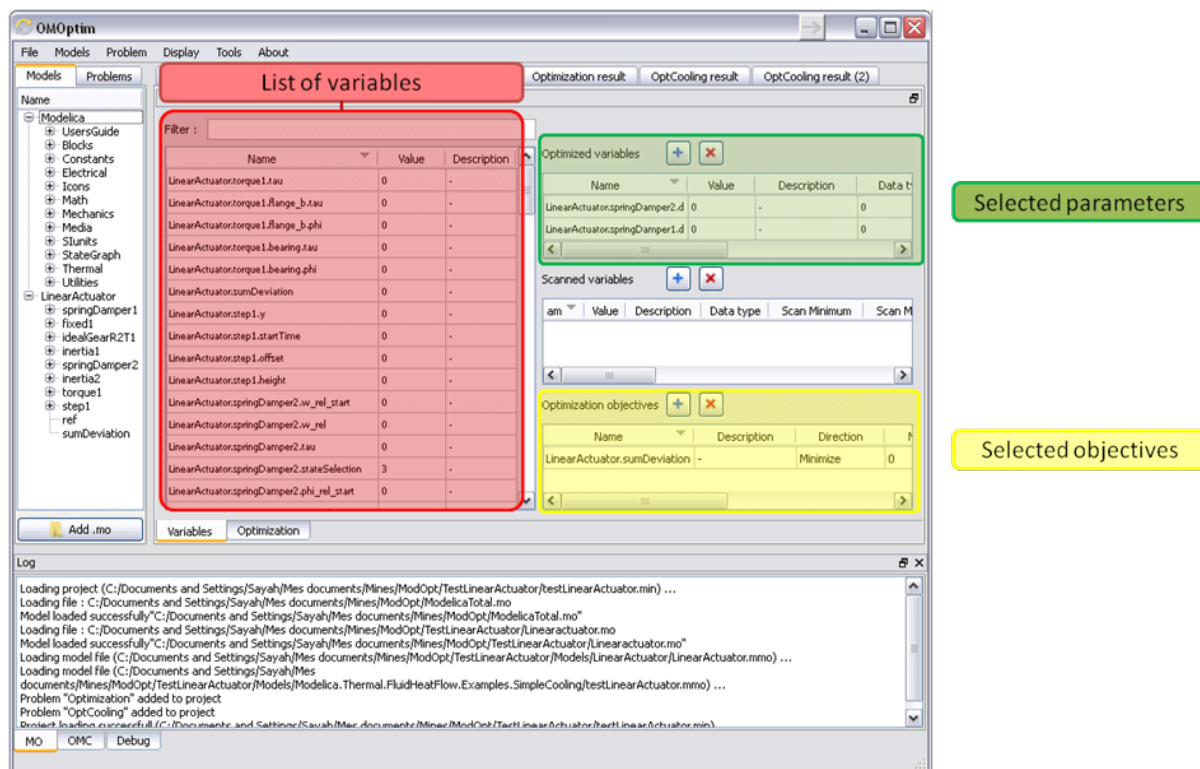

Figure 12.4: Forms for defining a new optimization problem.

List of Variables is Empty

If variables are not displayed, right click on model name in model hierarchy, and select *Read variables*.

Select Optimized Variables

To set optimization, we first have to define the variables the optimizer will consider as free *i.e.* those that it should find best values of. To do this, select in the left list, the variables concerned. Then, add them to *Optimized variables* by clicking on corresponding button (+).

For each variable, you must set minimum and maximum values it can take. This can be done in the *Optimized variables* table.

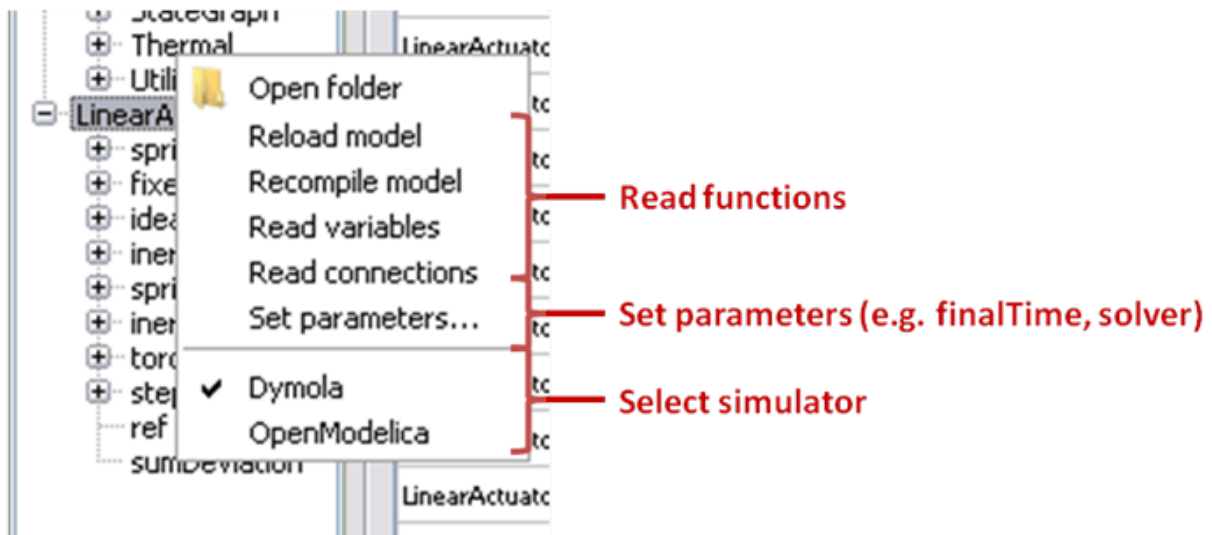

Figure 12.5: Selecting read variables, set parameters, and selecting simulator.

Select objectives

Objectives correspond to the final values of chosen variables. To select these last, select in left list variables concerned and click **+** button of *Optimization objectives* table.

For each objective, you must:

- **Set minimum and maximum values it can take. If a configuration does not respect these values, this configuration won't be considered.** You also can set minimum and maximum equals to “-“ : it will then
- Define whether objective should be minimized or maximized.

This can be done in the *Optimized variables* table.

Select and configure algorithm

After having selected variables and objectives, you should now select and configure optimization algorithm. To do this, click on *Optimization* tab.

Here, you can select optimization algorithm you want to use. In version 0.9, OMOptim offers three different genetic algorithms. Let's for example choose SPEA2Adapt which is an auto-adaptative genetic algorithm.

By clicking on *parameters...* button, a dialog is opened allowing defining parameters. These are:

- **Population size: this is the number of configurations kept after a** generation. If it is set to 50, your final result can't contain more than 50 different points.
- **Off spring rate: this is the number of children per adult obtained** after combination process. If it is set to 3, each generation will contain 150 individual (considering population size is 50).
- **Max generations: this number defines the number of generations** after which optimization should stop. In our case, each generation corresponds to 150 simulations. Note that you can still stop optimization while it is running by clicking on *stop* button (which will appear once optimization is launched). Therefore, you can set a really high number and still stop optimization when you want without losing results obtained until there.
- **Save frequency: during optimization, best configurations can be** regularly saved. It allows to analyze evolution of best configurations but also to restart an optimization from previously obtained results. A Save Frequency parameter set to 3 means that after three generations, a file is automatically created containing best configurations. These files are named *iteration1.sav*, *iteration2.sav* and are store in *Temp* directory, and moved to *SolvedProblems* directory when optimization is finished.

- **ReinitStdDev**: this is a specific parameter of EAAadapt1. It defines whether standard deviation of variables should be reinitialized. It is used only if you start optimization from previously obtained configurations (using *Use start file* option). Setting it to yes (1) will, in most of cases, lead to a spread research of optimized configurations, forgetting parameters' variations' reduction obtained in previous optimization.

Use start file

As indicated before, it is possible to pursue an optimization finished or stopped. To do this, you must enable *Use start file* option and select file from which optimization should be started. This file is an *iteration_.sav* file created in previous optimization. It is stored in corresponding *SolvedProblems* folder (*iteration10.sav* corresponds to the tenth generation of previous optimization).

Note that this functionality can only work with same variables and objectives. However, minimum, maximum of variables and objectives can be changed before pursuing an optimization.

Launch

You can now launch Optimization by clicking *Launch* button.

Stopping Optimization

Optimization will be stopped when the generation counter will reach the generation number defined in parameters. However, you can still stop the optimization while it is running without losing obtained results. To do this, click on *Stop* button. Note that this will not immediately stop optimization: it will first finish the current generation.

This stop function is especially useful when optimum points do not vary any more between generations. This can be easily observed since at each generation, the optimum objectives values and corresponding parameters are displayed in log window.

12.6.3 Results

The result tab appear when the optimization is finished. It consists of two parts: a table where variables are displayed and a plot region.

Obtaining all Variable Values

During optimization, the values of optimized variables and objectives are memorized. The others are not. To get these last, you must recomputed corresponding points. To achieve this, select one or several points in point's list region and click on *recompute*.

For each point, it will simulate model setting input parameters to point corresponding values. All values of this point (including those which are not optimization parameters neither objectives).

12.6.4 Window Regions in OMOptim GUI



Figure 12.6: Window regions in OMOptim GUI.

PARAMETER SENSITIVITIES WITH OPENMODELICA

This section describes the use of OpenModelica to compute parameter sensitivities using forward sensitivity analysis together with the Sundials/IDA solver.

13.1 Single Parameter sensitivities with IDA/Sundials

13.1.1 Background

Parameter sensitivity analysis aims at analyzing the behavior of the corresponding model states w.r.t. model parameters.

Formally, consider a Modelica model as a DAE system:

$$F(x, \dot{x}, y, p, t) = 0 \quad x(t_0) = x_0(p)$$

where $x(t) \in \mathbf{R}^n$ represent state variables, $\dot{x}(t) \in \mathbf{R}^n$ represent state derivatives, $y(t) \in \mathbf{R}^k$ represent algebraic variables, $p \in \mathbf{R}^m$ model parameters.

For parameter sensitivity analysis the derivatives

$$\frac{\partial x}{\partial p}$$

are required which quantify, according to their mathematical definition, the impact of parameters p on states x . In the Sundials/IDA implementation the derivatives are used to evolve the solution over the time by:

$$\dot{s}_i = \frac{\partial x}{\partial p_i}$$

13.1.2 An Example

This section demonstrates the usage of the sensitivities analysis in OpenModelica on an example. This module is enabled by the following OpenModelica compiler flag:

```
>>> setCommandLineOptions("--calculateSensitivities")
true
```

Listing 13.1: LotkaVolterra.mo

```
model LotkaVolterra
  Real x(start=5, fixed=true), y(start=3, fixed=true);
  parameter Real mu1=5, mu2=2;
  parameter Real lambda1=3, lambda2=1;
equation
  0 = x*(mu1-lambda1*y) - der(x);
  0 = -y*(mu2 -lambda2*x) - der(y);
end LotkaVolterra;
```

Also for the simulation it is needed to set IDA as solver integration method and add a further simulation flag `-idaSensitivity` to calculate the parameter sensitivities during the normal simulation.

```
>>> simulate(LotkaVolterra, method="ida", simflags="-idaSensitivity")
record SimulationResult
  resultFile = "«DOCHOME»/LotkaVolterra_res.mat",
  simulationOptions = "startTime = 0.0, stopTime = 1.0, numberOfIntervals = 500,
↳tolerance = 1e-06, method = 'ida', fileNamePrefix = 'LotkaVolterra', options = '
↳', outputFormat = 'mat', variableFilter = '.*', cflags = '', simflags = '-
↳idaSensitivity'",
  messages = "LOG_SUCCESS      | info      | The initialization finished,
↳successfully without homotopy method.
LOG_SUCCESS      | info      | The simulation finished successfully.
",
  timeFrontend = 0.005843839,
  timeBackend = 0.00251986,
  timeSimCode = 0.000782779,
  timeTemplates = 0.003620155,
  timeCompile = 0.387650411,
  timeSimulation = 0.01797498,
  timeTotal = 0.418508233
end SimulationResult;
```

Now all calculated sensitivities are stored into the results mat file under the `$Sensitivities` block, where all currently every **top-level** parameter of the Real type is used to calculate the sensitivities w.r.t. **every state**.

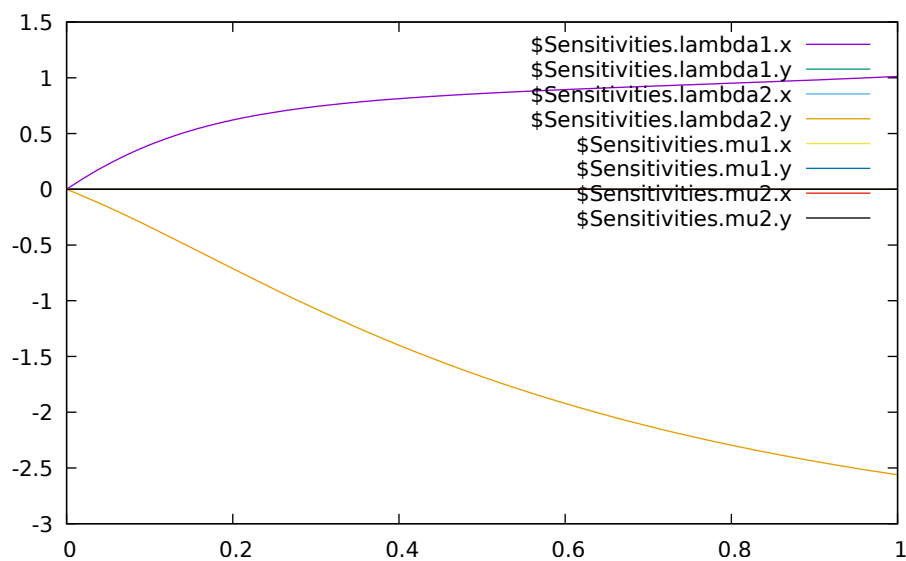

Figure 13.1: Results of the sensitivities calculated by IDA solver.

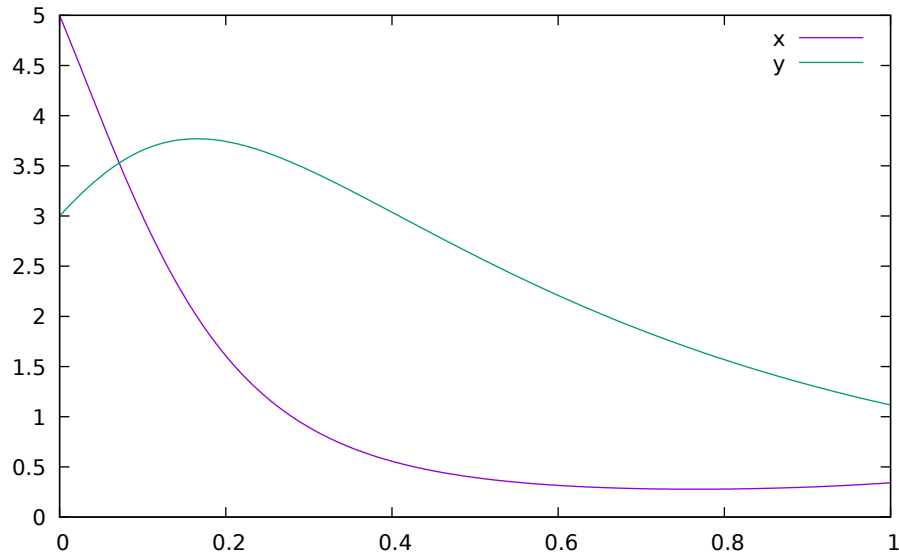

Figure 13.2: Results of the Lotka-Volterra equations.

13.2 Single and Multi-parameter sensitivities with OMSens

OMSens is an OpenModelica sensitivity analysis and optimization module.

13.2.1 Installation

The core files of OMSens are provided as part of the OpenModelica installation. However, you still need to install python and build OMSens with that python before using it. Follow the build/install instructions described on the [OMSens github page](#).

13.2.2 Usage

OMSens offers 3 flavors for parameter sensitivity analysis.

- Individual Sensitivity Analysis
- Used to analyze how a parameter affects a variable when perturbed on its own
- Multi-parameter Sweep
- Exploratory experimentation that sweeps the space of a set of parameters
- Vectorial Sensitivity Analysis
- Used to find the combination of parameters that maximizes/minimizes a state variable

As an example, we choose the Lotka-Volterra model that consists of a second-order nonlinear set of ordinary differential equations. The system models the relationship between the populations of predators and preys in a closed ecosystem.

```

model LotkaVolterra "This is the typical equation-oriented model"
  parameter Real alpha=0.1 "Reproduction rate of prey";
  parameter Real beta=0.02 "Mortality rate of predator per prey";
  parameter Real gamma=0.4 "Mortality rate of predator";
  parameter Real delta=0.02 "Reproduction rate of predator per prey";
  parameter Real prey_pop_init=10 "Initial prey population";
  parameter Real pred_pop_init=10 "Initial predator population";
  Real prey_pop(start=prey_pop_init) "Prey population";
  Real pred_pop(start=pred_pop_init) "Predator population";
initial equation
  prey_pop = prey_pop_init;
  pred_pop = pred_pop_init;
equation
  der(preypop) = prey_pop*(alpha-beta*pred_pop);
  der(predpop) = pred_pop*(delta*prey_pop-gamma);
end LotkaVolterra;

```

Individual Sensitivity Analysis

- Select *Sensitivity Optimization > Run Sensitivity Analysis and Optimization* from the menu. A window like the one below should appear.



Figure 13.3: OMSens window.

- Choose **Individual Parameter Based Sensitivity Analysis** and set up the simulation settings.

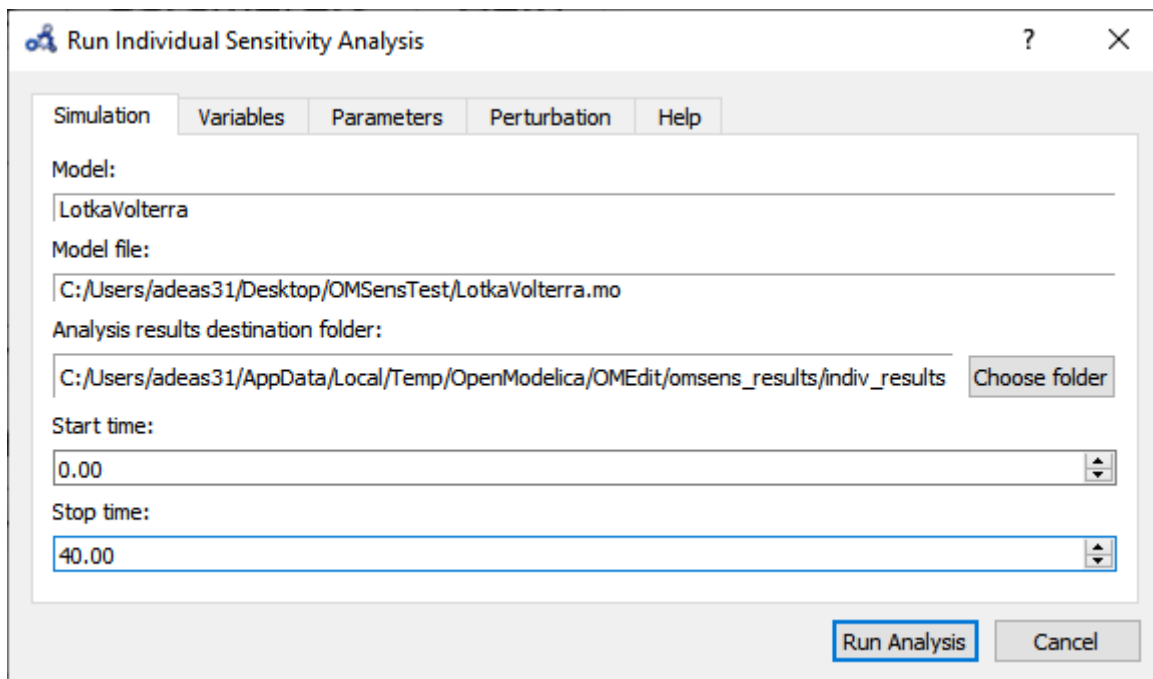

Figure 13.4: Run individual sensitivity analysis.

- Select variables.
- Select parameters.
- Choose the perturbation percentage and direction. Run the analysis.
- After the analysis a dialog with results is shown. Open the heatmap corresponding to the relative sensitivity index.



Figure 13.5: Individual sensitivity analysis variables.



Figure 13.6: Individual sensitivity analysis parameters.

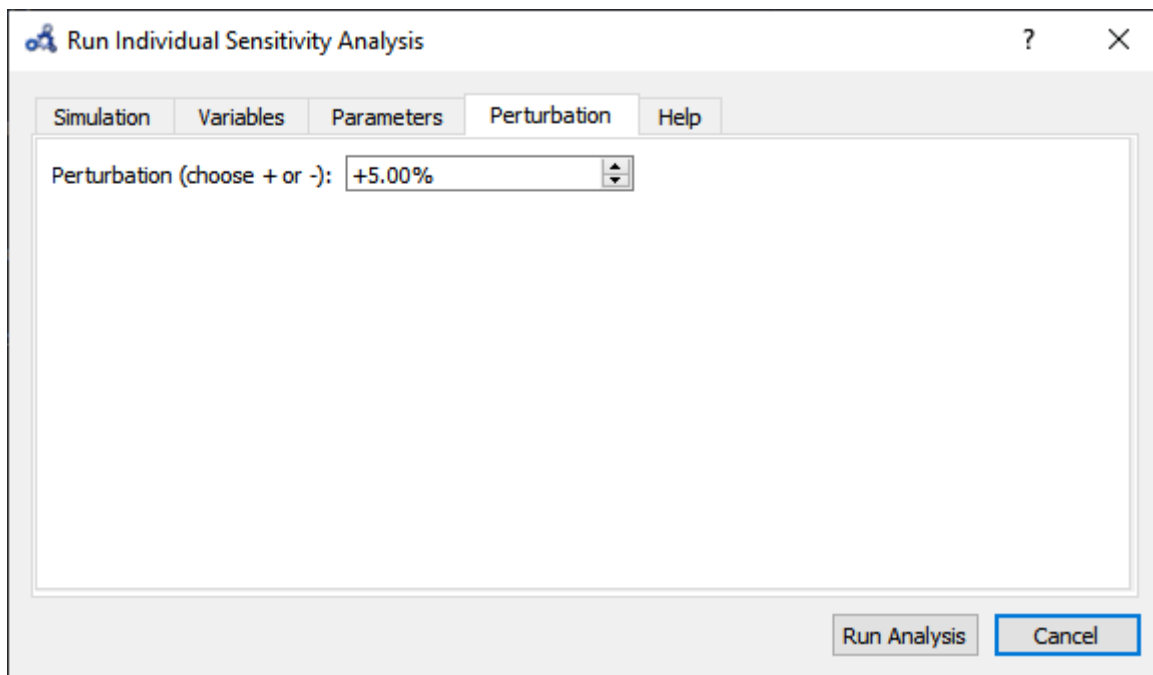

Figure 13.7: Individual sensitivity analysis perturbation.

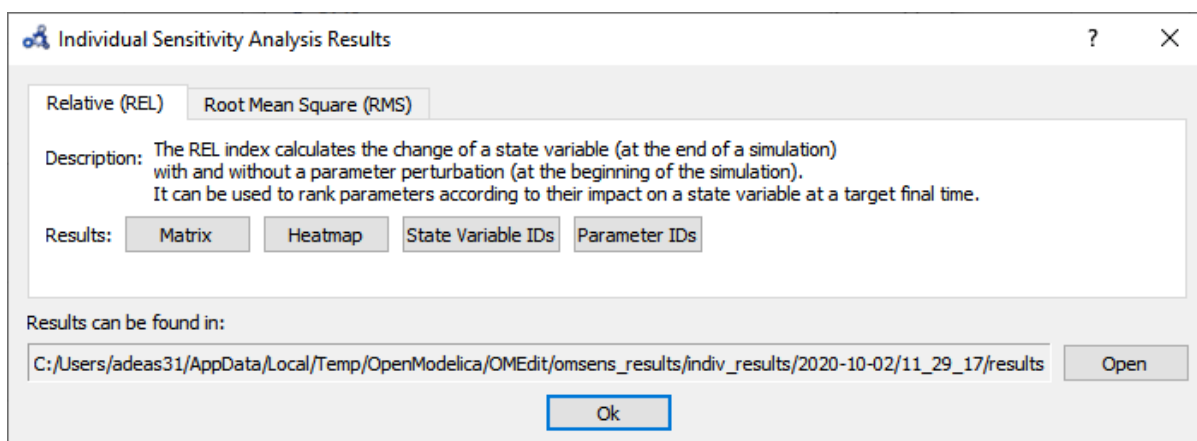

Figure 13.8: Individual sensitivity analysis results.

- The heatmap shows the effect of each parameter on each variable in the form of (parameter,variable) cells. As we can see, `pred_pop` was affected by the perturbation on every parameter but `prey_pop` presents a negligible sensitivity to delta (P.3). Recall that this heatmap shows the effect on the variables at time 40 for each perturbation imposed at time 0.



Figure 13.9: Individual sensitivity analysis heatmap.

Multi-parameter Sweep

Now we would like to see what happens to `pred_pop` when the top 3 most influencing parameters are perturbed at the same time. Repeat the first three steps from *Individual Sensitivity Analysis* but this time select **Multi-parameter Sweep**.

- Choose to sweep alpha, gamma and `pred_pop_init` in a range of $\pm 5\%$ from its default value and with 3 iterations (`#iter`) distributed equidistantly within that range. Run the sweep analysis.
- The backend is invoked and when it completes the analysis the following results dialog is shown. Open the plot for `pred_pop`.
- At time 40 the parameters perturbations with a higher predator population are all blue, but it's not clear which one. We need something more precise.

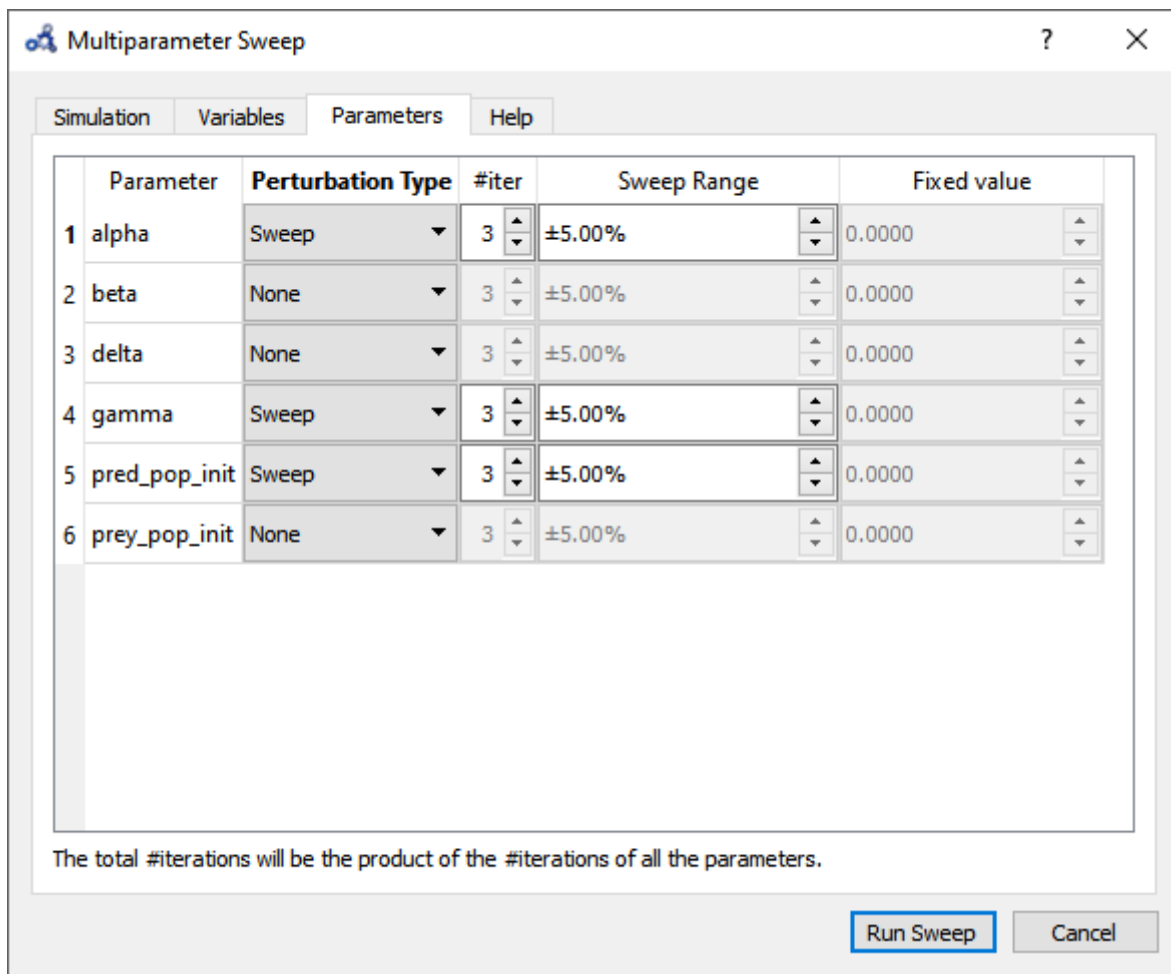

Figure 13.10: Multi-parameter sweep parameters.



Figure 13.11: Multi-parameter sweep results.

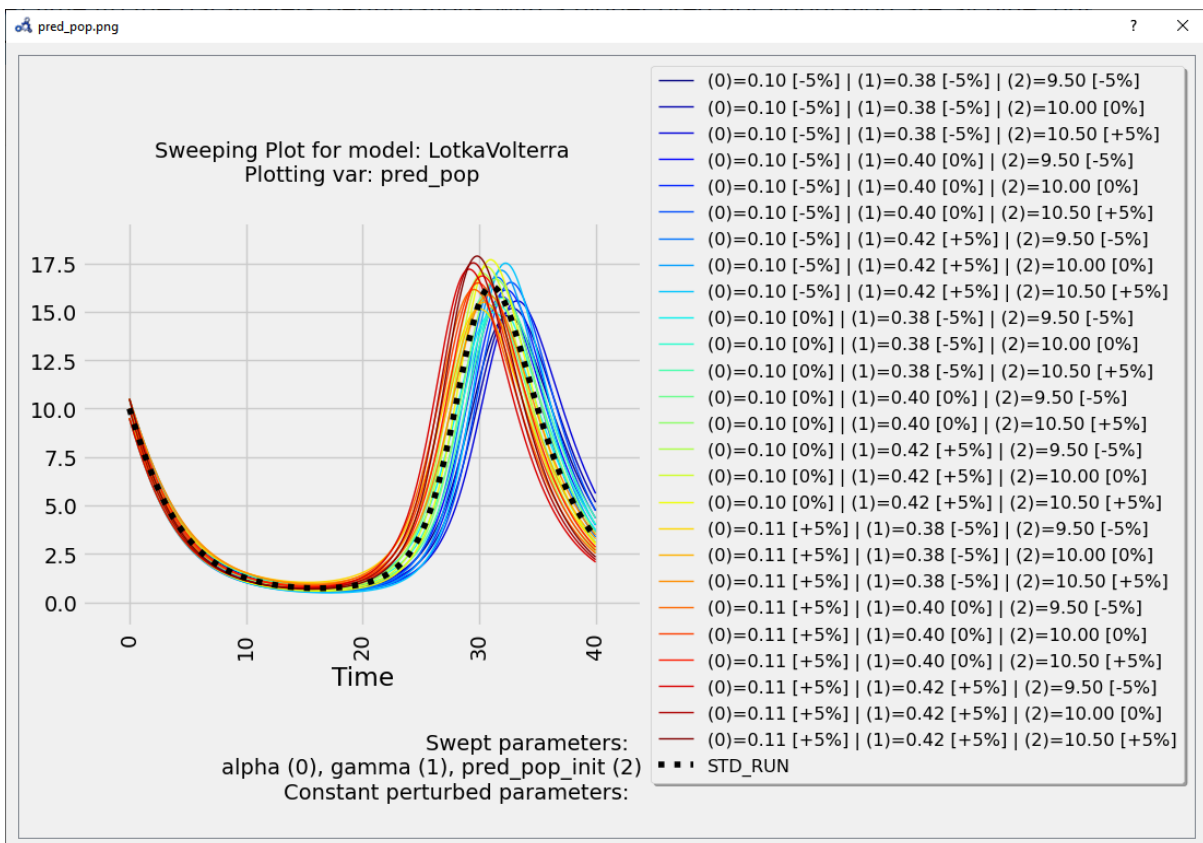

Figure 13.12: Multi-parameter sweep plot.

These results can be very informative but clearly the exhaustive exploration approach doesn't scale for more parameters (#p) and more perturbation values (#v) ($\#v^{\#p}$ simulations required).

Vectorial Sensitivity Analysis

Using the Vectorial optimization-based analysis (see below) we can request OMSens to find a combination of parameters that perturbs the most (i.e. minimize or maximize) the value of the target variable at a desired simulation time.

For **Vectorial Sensitivity Analysis** repeat the first two steps from *Individual Sensitivity Analysis* but choose **Vectorial Parameter Based Sensitivity Analysis**.

- Choose only alpha, delta and pred_pop_init to perturb.

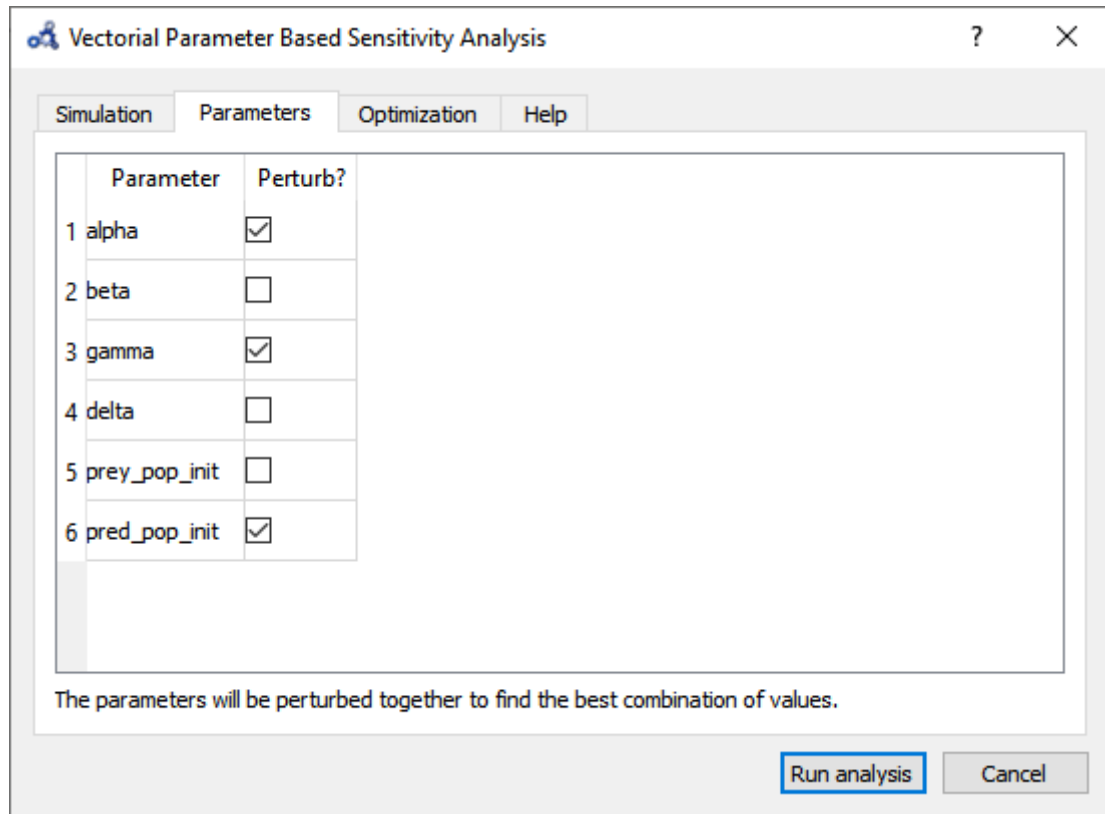

Figure 13.13: Vectorial sensitivity analysis parameters.

- Setup the optimization settings and run the analysis.
- The **Parameters** tab in the results window shows the values found by the optimization routine that maximize pred_pop at t=40 s.
- The **State Variable** tab shows the comparison between the values of the variable in the standard run vs the perturbed run at simulation time 40s.
- If we simulate using the optimum values and compare it to the standard (unperturbed) run, we see that it **delays the bell** described by the variable.
- So far, we have only perturbed the top 3 parameters detected by the **Individual Sensitivity** method. Maybe we can find a greater effect on the variable if we perturb all 6 parameters. Running a Sweep is not an option as perturbing 6 parameters with 3 iterations each results in $3^6=729$ simulations. We run another Vectorial Sensitivity Analysis instead but now choose to perturb all 6 parameters.
- The **parameters tab** shows that the optimum value is found by perturbing all of the parameters to their boundaries.
- The **State Variable** tab shows that pred_pop can be increased by 98% when perturbing the 6 parameters as opposed to 68% when perturbing the top 3 influencing parameters.
- The plot shows again that the parameters found delay the bell-shaped curve, but with a stronger impact than before.



Figure 13.14: Vectorial sensitivity analysis optimization.



Figure 13.15: Vectorial sensitivity analysis parameters result.

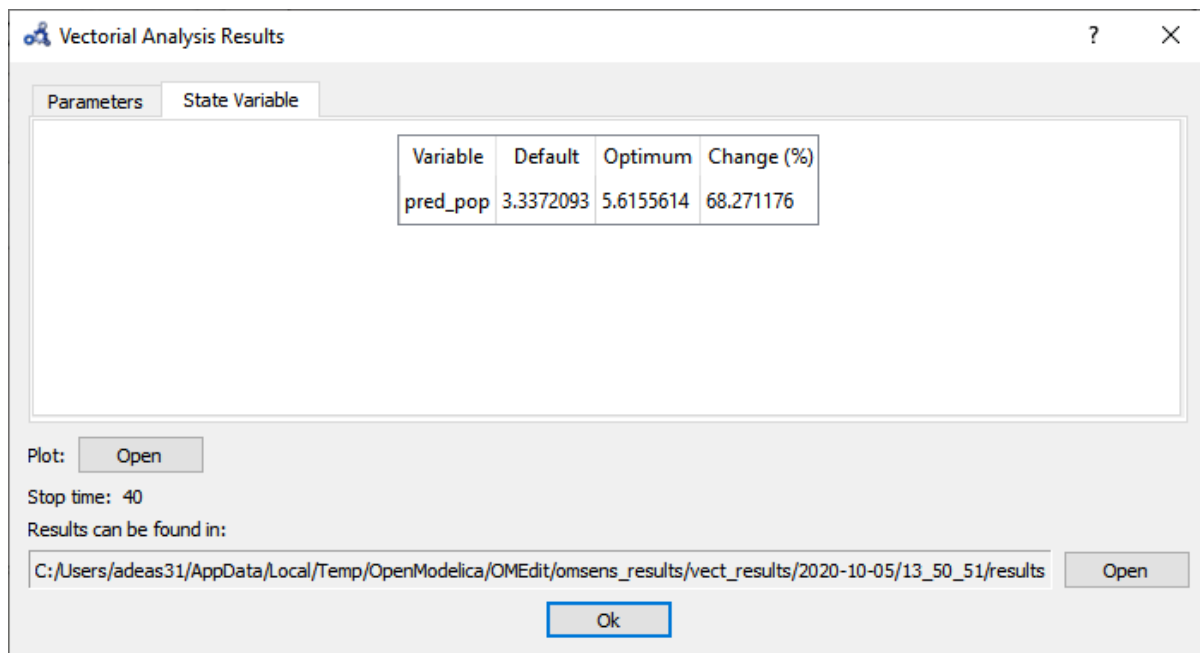

Figure 13.16: Vectorial sensitivity analysis state variables.

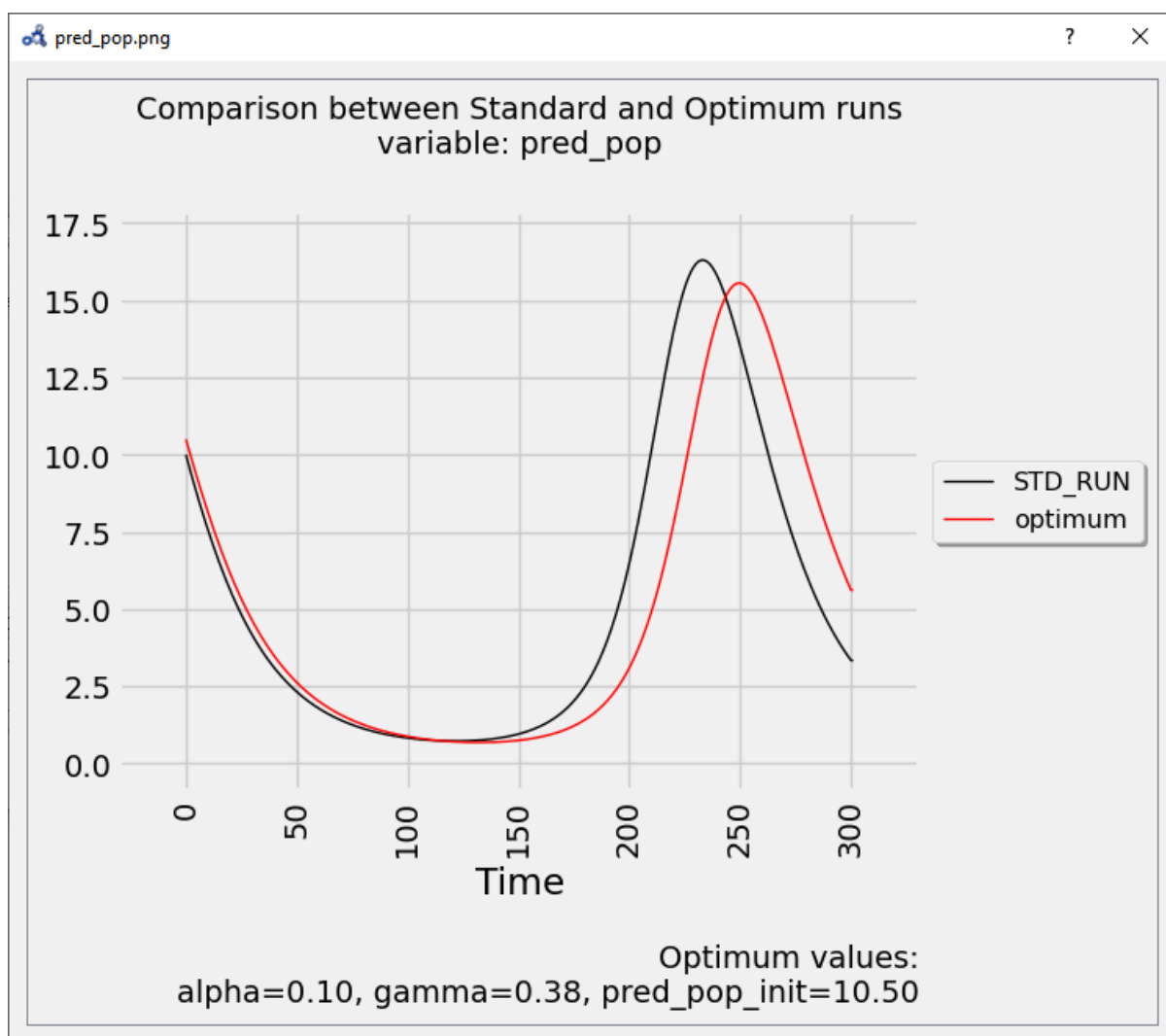

Figure 13.17: Vectorial sensitivity analysis plot.

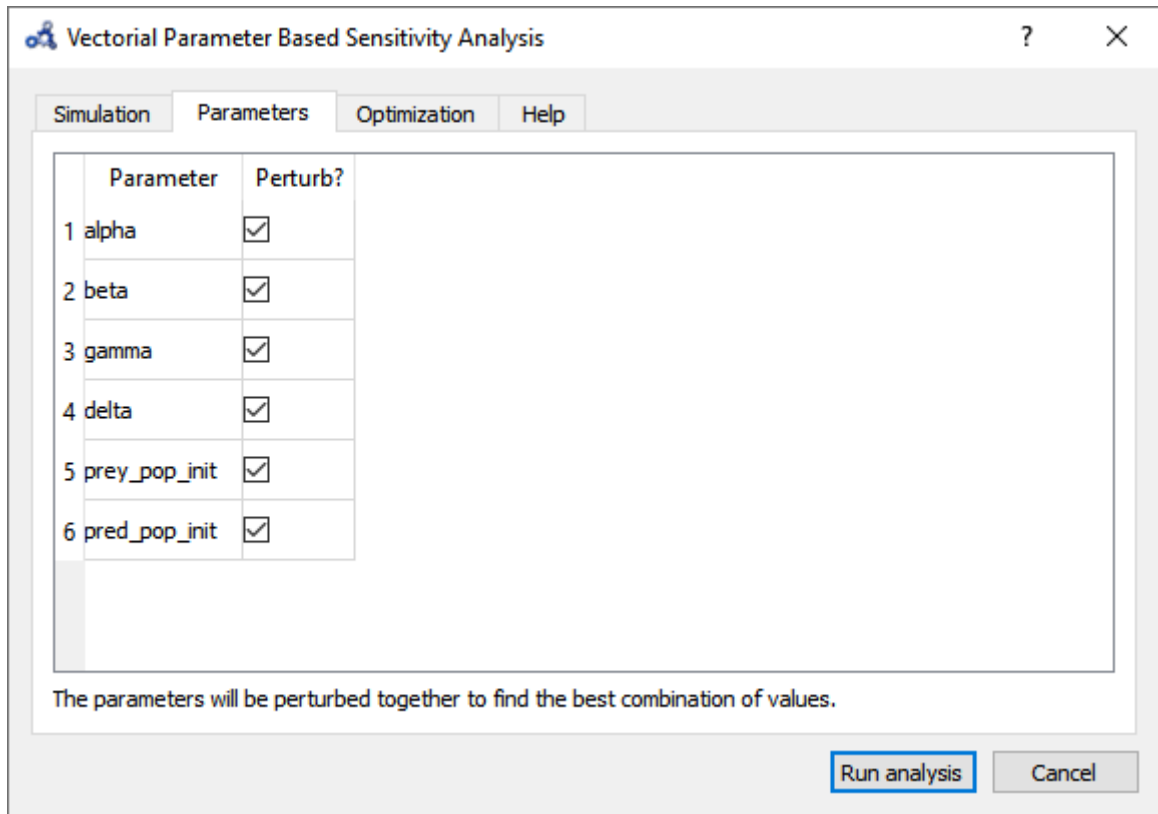

Figure 13.18: Vectorial sensitivity analysis parameters.

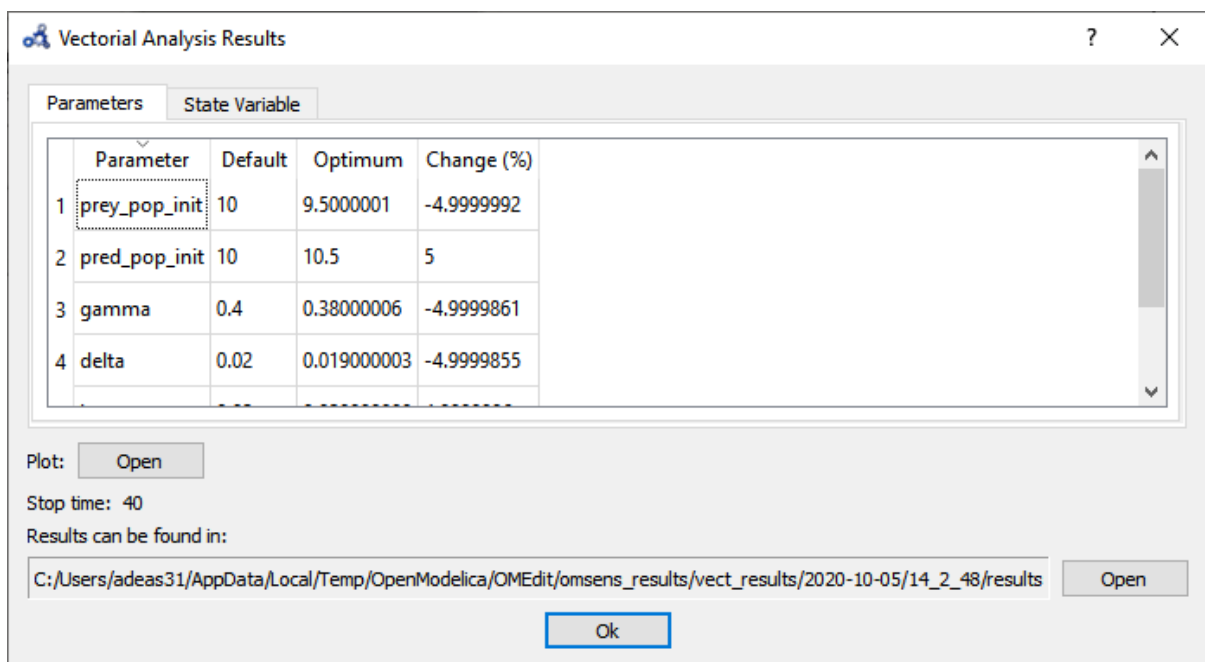

Figure 13.19: Vectorial sensitivity analysis parameters result.

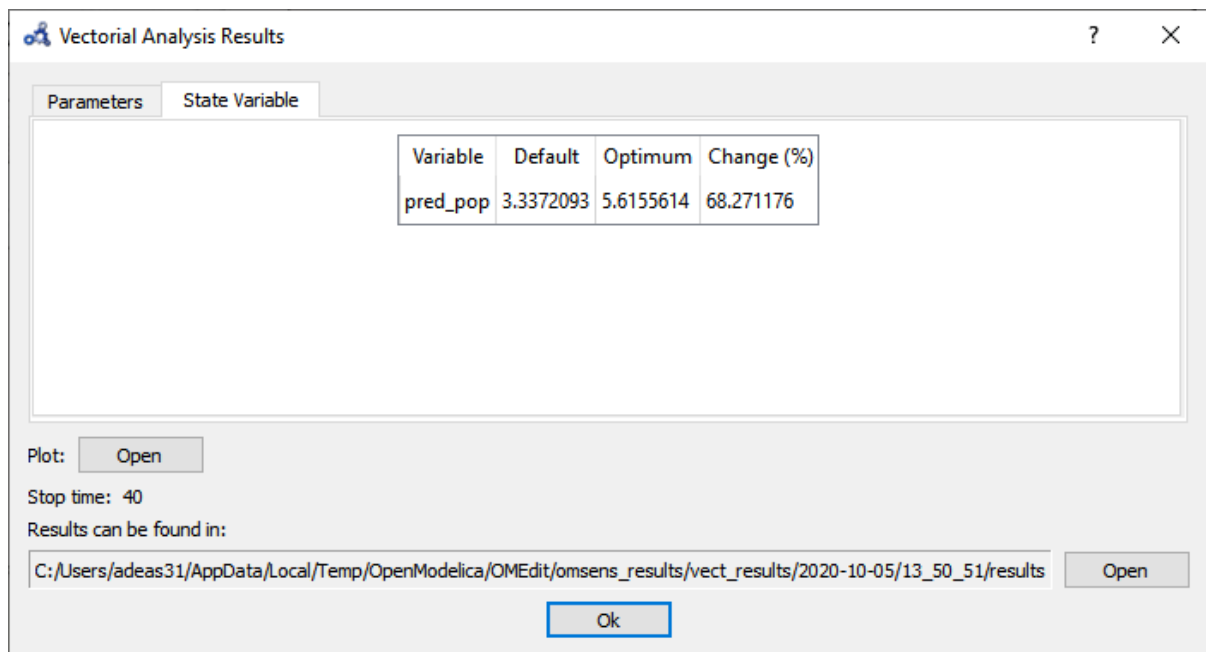

Figure 13.20: Vectorial sensitivity analysis state variables.

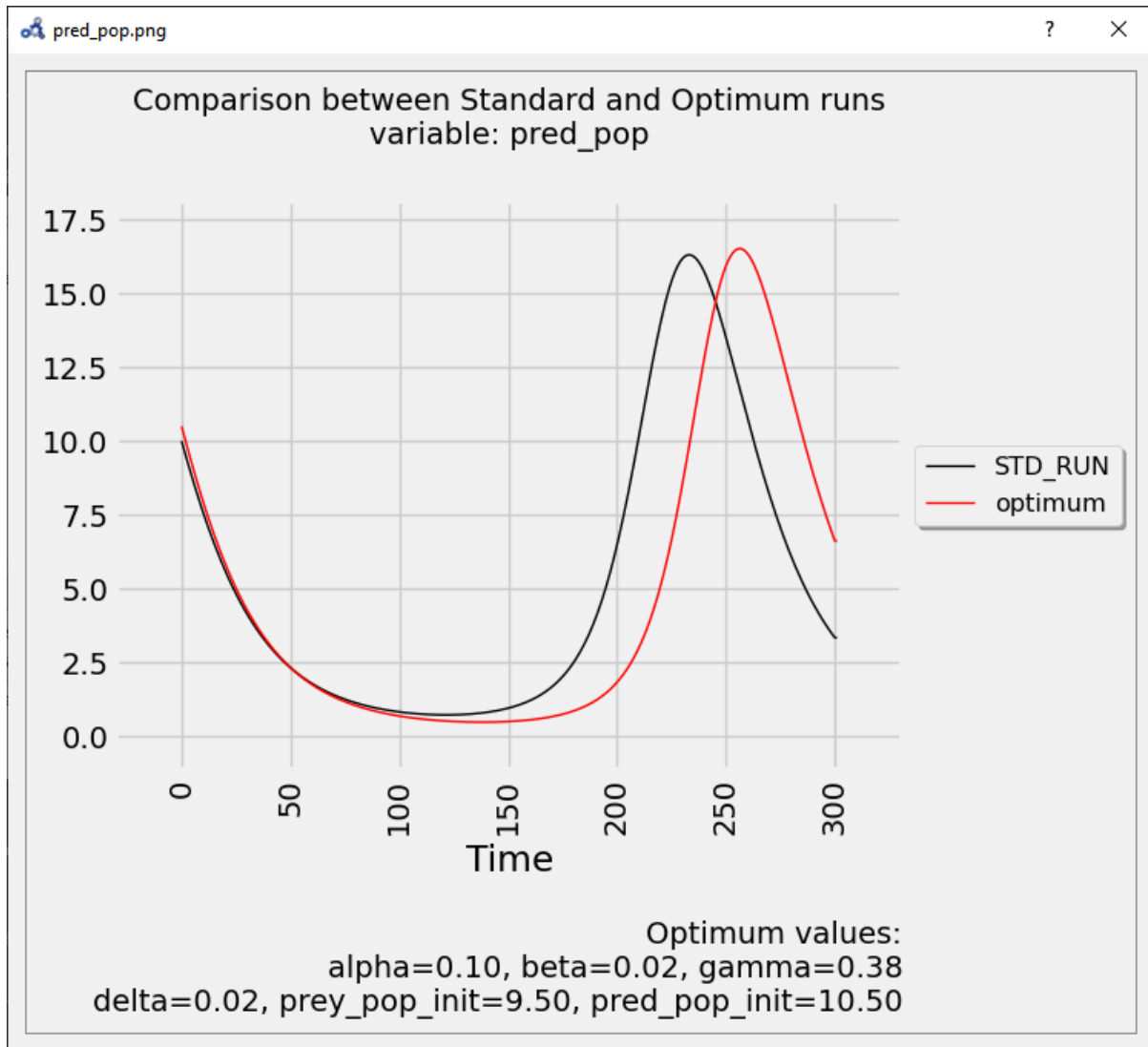

Figure 13.21: Vectorial sensitivity analysis plot.

PDEMODELICA1

PDEModelica1 is nonstandardised experimental Modelica language extension for 1-dimensional partial differential extensions (PDE).

It is enabled using compiler flag `--grammar=PDEModelica`. Compiler flags may be set e.g. in OMEdit (Tools->Options->Simulation->OMC Flags) or in the OpenModelica script using command

14.1 PDEModelica1 language elements

Let us introduce new PDEModelica1 language elements by an advection equation example model:

```
model Advection "advection equation"
  parameter Real pi = Modelica.Constants.pi;
  parameter DomainLineSegment1D omega(L = 1, N = 100) "domain";
  field Real u(domain = omega) "field";
initial equation
  u = sin(2*pi*omega.x) "IC";
equation
  der(u) + pder(u,x) = 0 indomain omega "PDE";
  u = 0 indomain omega.left "BC";
  u = extrapolateField(u) indomain omega.right "extrapolation";
end Advection;
```

Error:

[<interactive>:4:14-4:14:writable] Error: Missing token: SEMICOLON

The domain `omega` represents the geometrical domain where the PDE holds. The domain is defined using the built-in record `DomainLineSegment1D`. This record contains among others `L` – the length of the domain, `N` – the number of grid points, `x` – the coordinate variable and the regions `left`, `right` and `interior`, representing the left and right boundaries and the interior of the domain.

The field variable `u` is defined using a new keyword `field`. The domain is a mandatory attribute to specify the domain of the field.

The `indomain` operator specifies where the equation containing the field variable holds. It is utilised in the initial conditions (IC) of the fields, in the PDE and in the boundary conditions (BC). The syntax is

```
anEquation indomain aDomain.aRegion;
```

If the region is omitted, `interior` is the default (e.g. the PDE in the example above).

The IC of the field variable `u` is written using an expression containing the coordinate variable `omega.x`.

The PDE contains a partial space derivative written using the `pder` operator. Also the second derivative is allowed (not in this example), the syntax is e.g. `pder (u, x, x)`. It is not necessary to specify the domain of coordinate in `pder` (to write e.g. `pder (u, omega . x)`, even though `x` is a member of `omega`).

14.2 Limitations

BCs may be written only in terms of variables that are spatially differentiated currently.

All fields that are spatially differentiated must have either BC or extrapolation at each boundary. This extrapolation should be done automatically by the compiler, but this has not been implemented yet. The current workaround is the usage of the `extrapolateField()` operator directly in the model.

If-equations are not supported yet, if-expressions must be used instead.

14.3 Viewing results

During translation field variables are replaced with arrays. These arrays may be plotted using *Array Plot* or even better using *Array Parametric Plot* (to plot x-coordinate versus a field).

MDT – THE OPENMODELICA DEVELOPMENT TOOLING ECLIPSE PLUGIN

15.1 Introduction

The Modelica Development Tooling (MDT) Eclipse Plugin as part of OMDev – The OpenModelica Development Environment integrates the OpenModelica compiler with Eclipse. MDT, together with the OpenModelica compiler, provides an environment for working with Modelica and MetaModelica development projects. This plugin is primarily intended for tool developers rather than application Modelica modelers.

The following features are available:

- Browsing support for Modelica projects, packages, and classes
- Wizards for creating Modelica projects, packages, and classes
- Syntax color highlighting
- Syntax checking
- Browsing of the Modelica Standard Library or other libraries
- Code completion for class names and function argument lists
- Goto definition for classes, types, and functions
- Displaying type information when hovering the mouse over an identifier.

15.2 Installation

The installation of MDT is accomplished by following the below installation instructions. These instructions assume that you have successfully downloaded and installed Eclipse (<http://www.eclipse.org>).

The latest installation instructions are available through the [OpenModelica Trac](#).

1. Start Eclipse
2. Select Help->Software Updates->Find and Install... from the menu
3. Select 'Search for new features to install' and click 'Next'
4. Select 'New Remote Site...'
5. Enter 'MDT' as name and <http://www.ida.liu.se/labs/pelab/modelica/OpenModelica/MDT> as URL and click 'OK'
6. Make sure 'MDT' is selected and click 'Finish'
7. In the updates dialog select the 'MDT' feature and click 'Next'
8. Read through the license agreement, select 'I accept...' and click 'Next'
9. Click 'Finish' to install MDT

15.3 Getting Started

15.3.1 Configuring the OpenModelica Compiler

MDT needs to be able to locate the binary of the compiler. It uses the environment variable OPENMODELICAHOME to do so.

If you have problems using MDT, make sure that OPENMODELICAHOME is pointing to the folder where the OpenModelica Compiler is installed. In other words, OPENMODELICAHOME must point to the folder that contains the Open Modelica Compiler (OMC) binary. On the Windows platform it's called omc.exe and on Unix platforms it's called omc.

15.3.2 Using the Modelica Perspective

The most convenient way to work with Modelica projects is to use the Modelica perspective. To switch to the Modelica perspective, choose the Window menu item, pick Open Perspective followed by Other... Select the Modelica option from the dialog presented and click OK..

15.3.3 Selecting a Workspace Folder

Eclipse stores your projects in a folder called a workspace. You need to choose a workspace folder for this session, see [Figure 15.1](#).

15.3.4 Creating one or more Modelica Projects

To start a new project, use the New Modelica Project Wizard. It is accessible through File->New-> Modelica Project or by right-clicking in the Modelica Projects view and selecting New->Modelica Project.

You need to disable automatic build for the project(s) ([Figure 15.3](#)).

Repeat the procedure for all the projects you need, e.g. for the exercises described in the MetaModelica users guide: 01_experiment, 02a_exp1, 02b_exp2, 03_assignment, 04a_assigntwoptype, etc.

NOTE: Leave open only the projects you are working on! Close all the others!

15.3.5 Building and Running a Project

After having created a project, you eventually need to build the project ([Figure 15.4](#)).

The build options are the same as the make targets: you can build, build from scratch (clean), or run simulations depending on how the project is setup. See [Figure 15.5](#) for an example of how omc can be compiled (`make omc` builds OMC).

15.3.6 Switching to Another Perspective

If you need, you can (temporarily) switch to another perspective, e.g. to the Java perspective for working with an OpenModelica Java client as in [Figure 15.7](#).



Figure 15.1: Eclipse Setup – Switching Workspace.

Create a Modelica project

Create a Modelica project in the workspace.



Project name:

demo



Cancel

Finish

Figure 15.2: Eclipse Setup – creating a Modelica project in the workspace.

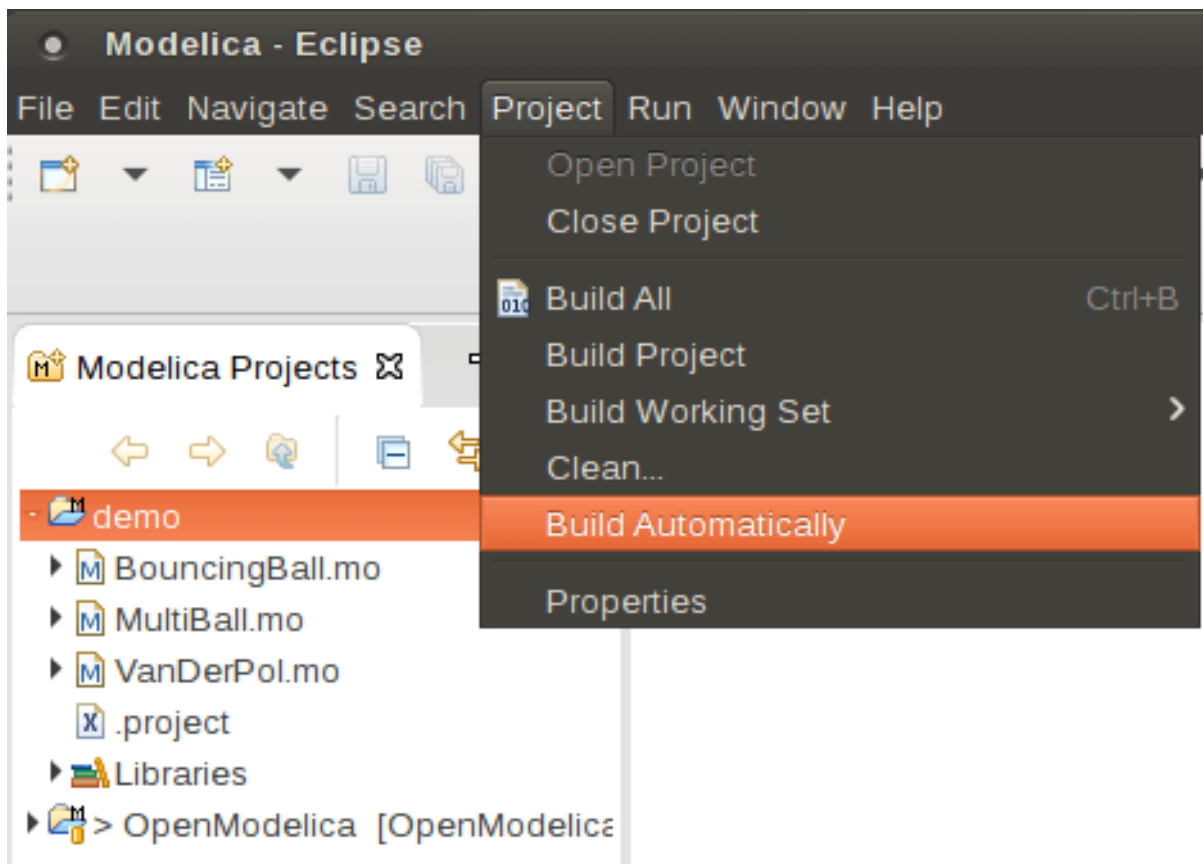

Figure 15.3: Eclipse Setup – disable automatic build for the projects.

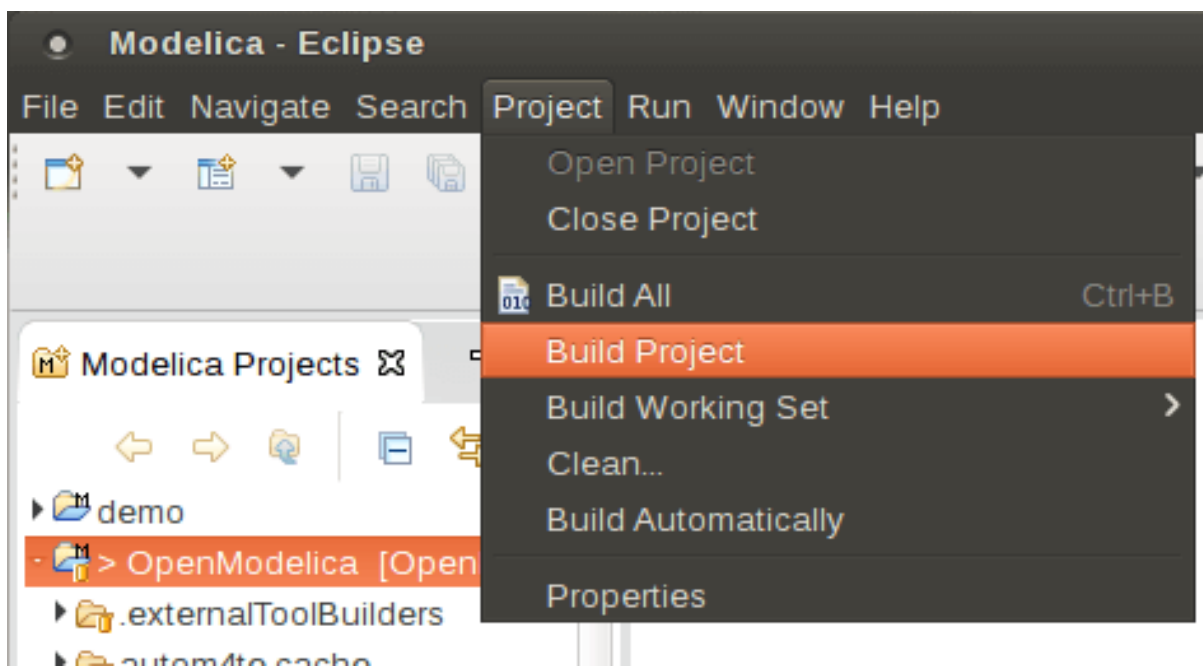

Figure 15.4: Eclipse MDT – Building a project.

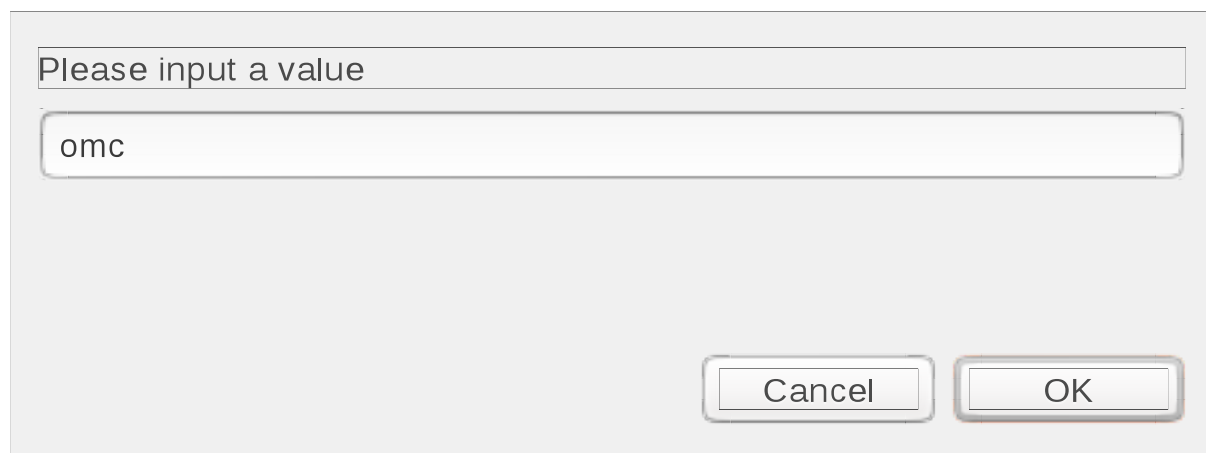

Figure 15.5: Eclipse – building a project.

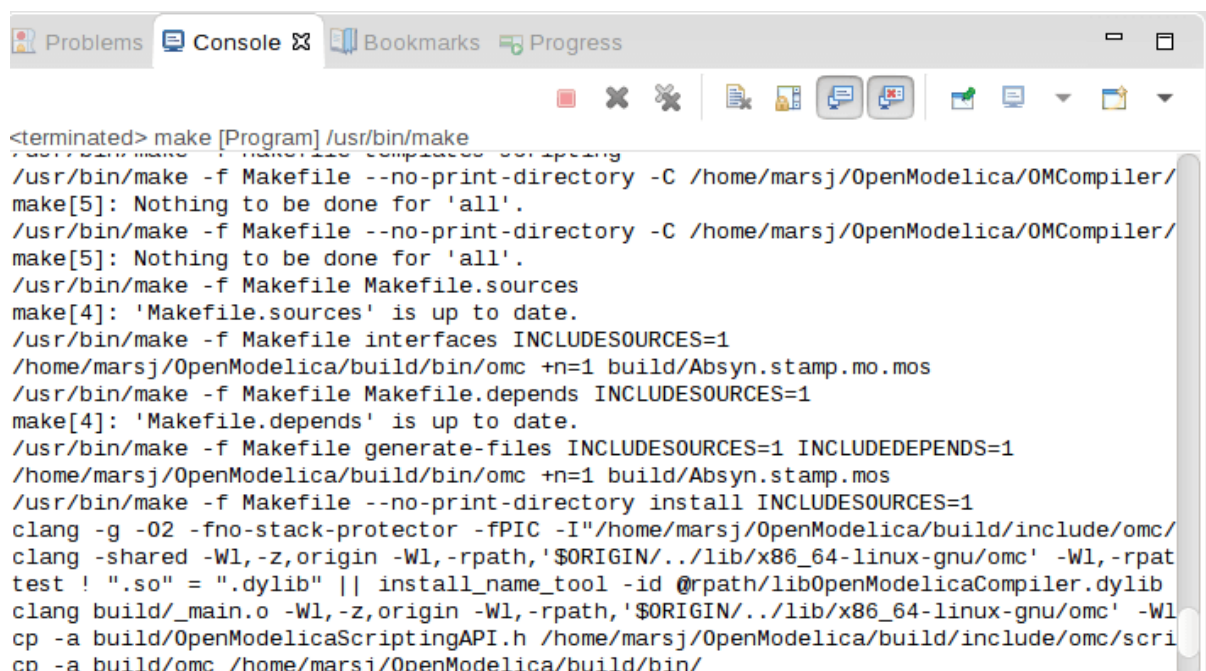

Figure 15.6: Eclipse – building a project, resulting log.

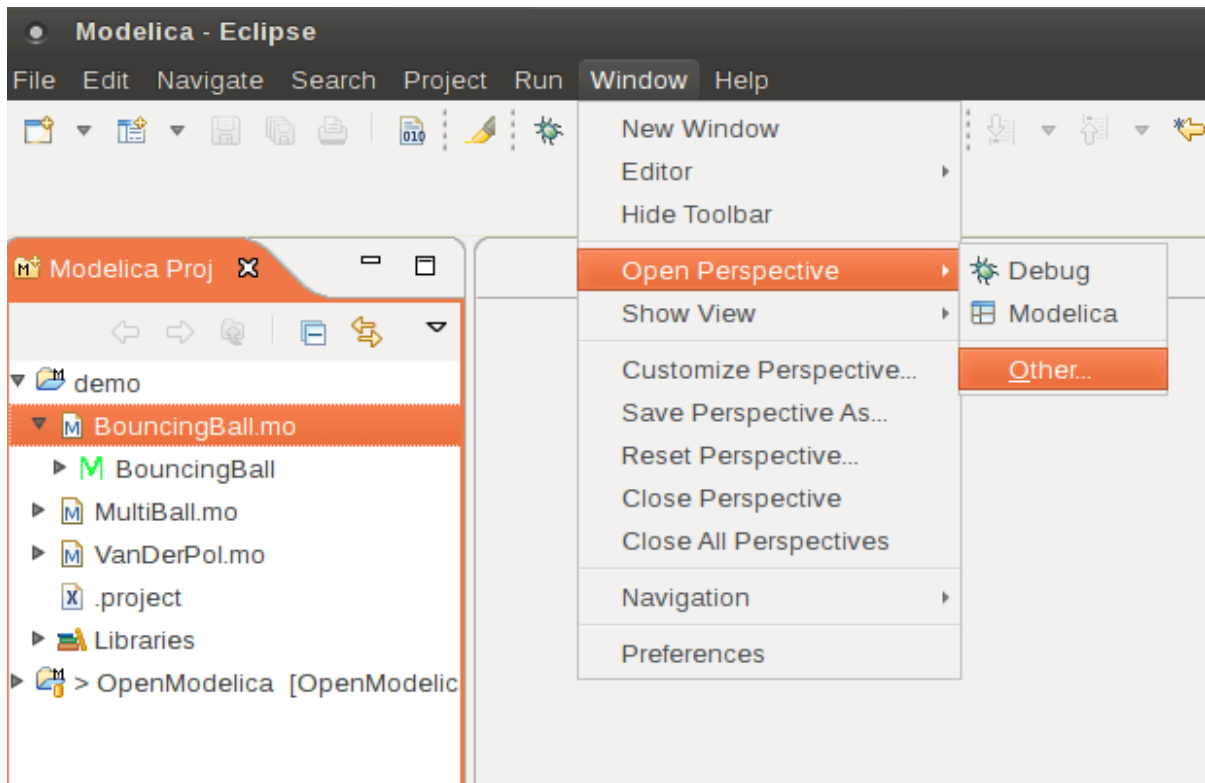

Figure 15.7: Eclipse – Switching to another perspective – e.g. the Java Perspective.

15.3.7 Creating a Package

To create a new package inside a Modelica project, select File->New->Modelica Package. Enter the desired name of the package and a description of what it contains. Note: for the exercises we already have existing packages.

15.3.8 Creating a Class

To create a new Modelica class, select where in the hierarchy that you want to add your new class and select File->New->Modelica Class. When creating a Modelica class you can add different restrictions on what the class can contain. These can for example be model, connector, block, record, or function. When you have selected your desired class type, you can select modifiers that add code blocks to the generated code. 'Include initial code block' will for example add the line 'initial equation' to the class.

15.3.9 Syntax Checking

Whenever a build command is given to the MDT environment, modified and saved Modelica (.mo) files are checked for syntactical errors. Any errors that are found are added to the Problems view and also marked in the source code editor. Errors are marked in the editor as a red circle with a white cross, a squiggly red line under the problematic construct, and as a red marker in the right-hand side of the editor. If you want to reach the problem, you can either click the item in the Problems view or select the red box in the right-hand side of the editor.

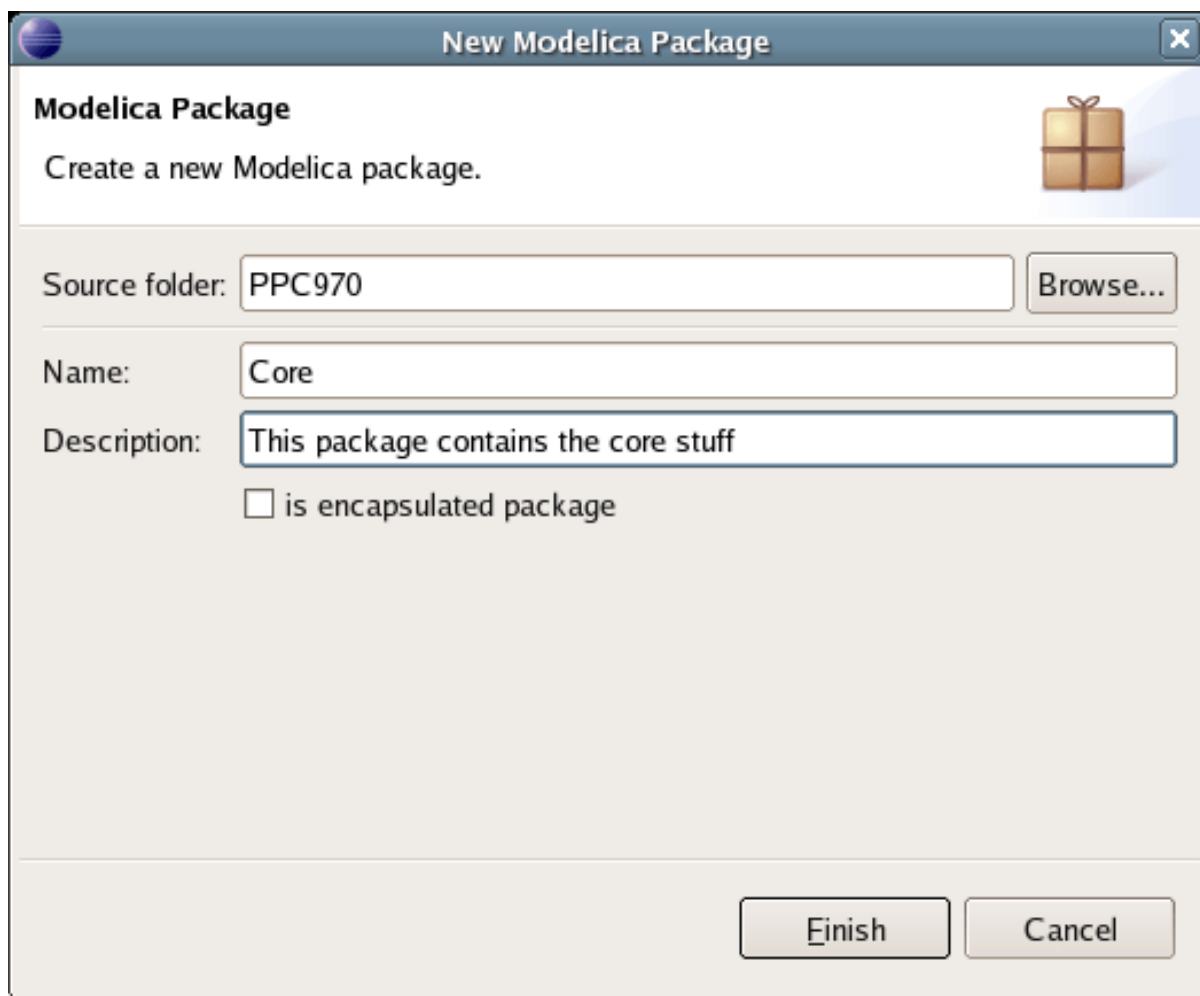

Figure 15.8: Creating a new Modelica package.



Figure 15.9: Creating a new Modelica class.

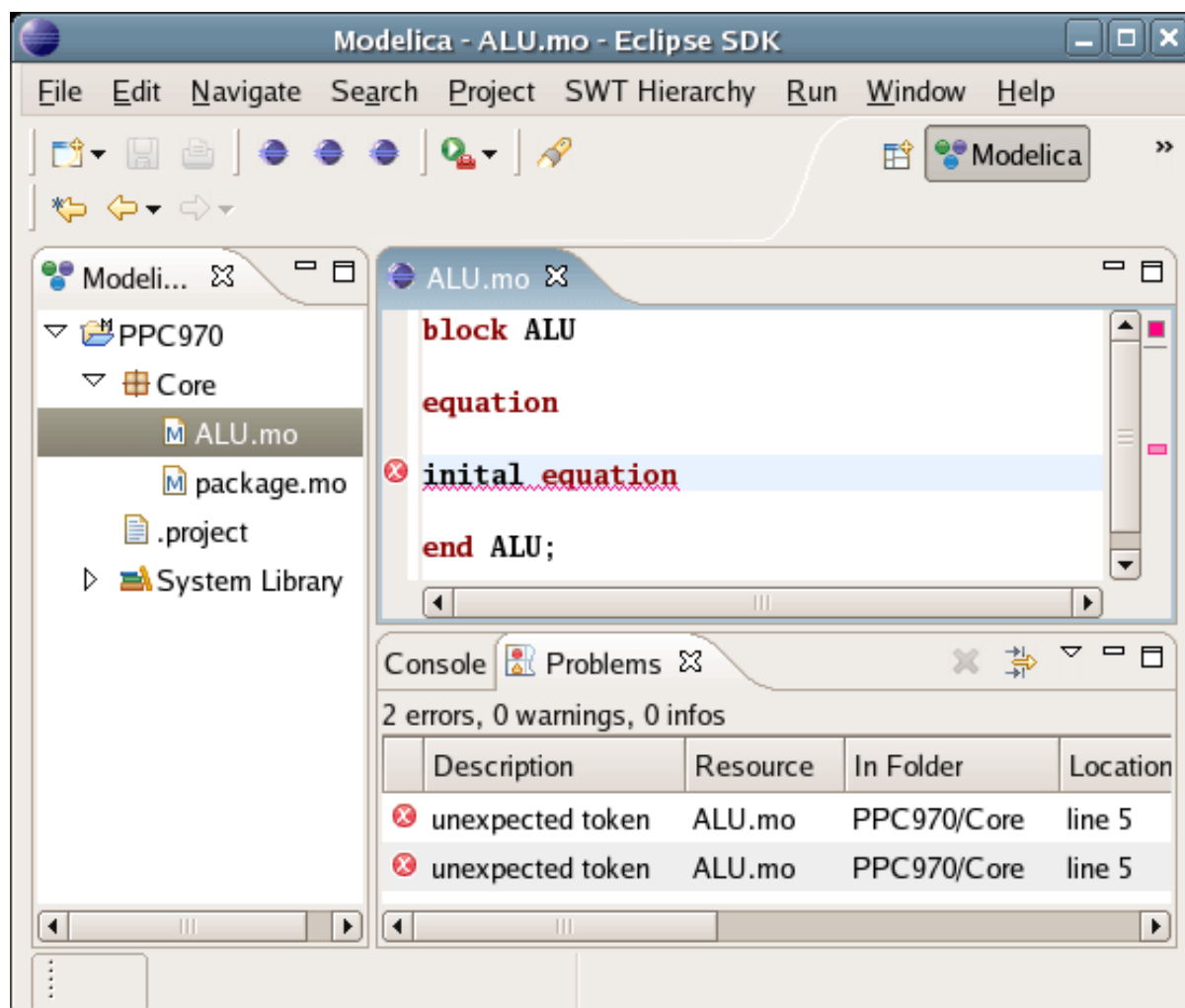

Figure 15.10: Syntax checking.

15.3.10 Automatic Indentation Support

MDT currently has support for automatic indentation. When typing the Return (Enter) key, the next line is indented correctly. You can also correct indentation of the current line or a range selection using CTRL+I or “Correct Indentation” action on the toolbar or in the Edit menu.

15.3.11 Code Completion

MDT supports Code Completion in two variants. The first variant, code completion when typing a dot after a class (package) name, shows alternatives in a menu. Besides the alternatives, Modelica documentation from comments is shown if it is available. This makes the selection easier.

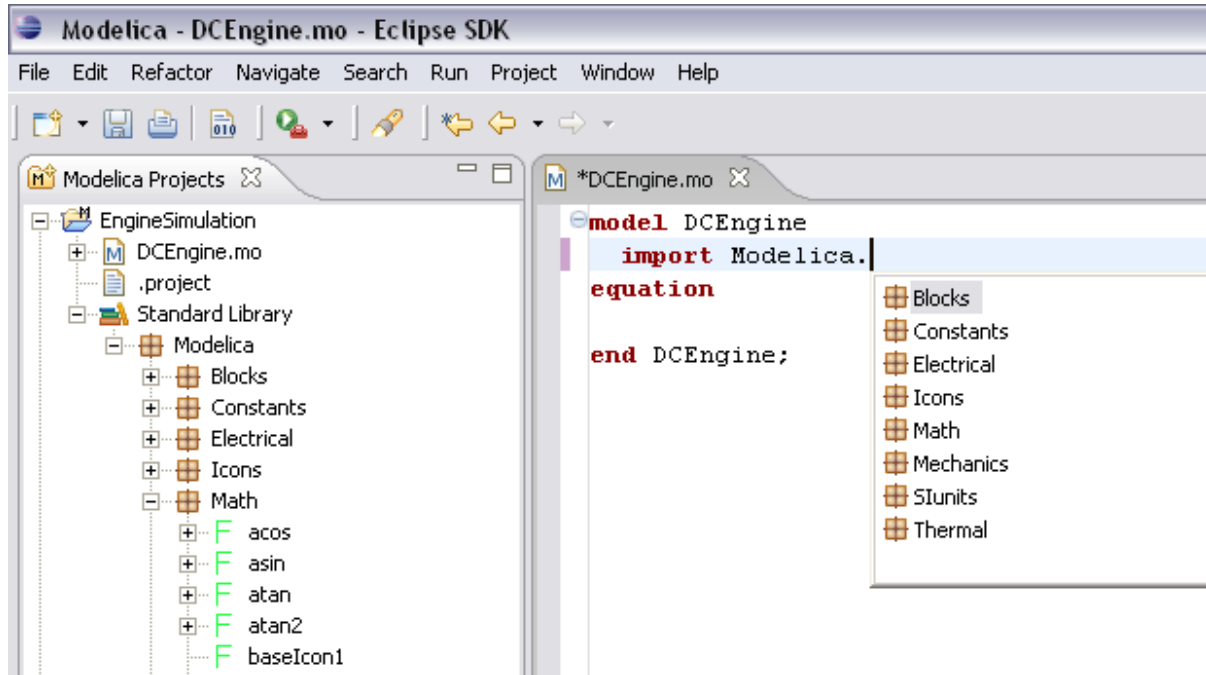

Figure 15.11: Code completion when typing a dot.

The second variant is useful when typing a call to a function. It shows the function signature (formal parameter names and types) in a popup when typing the parenthesis after the function name, here the signature Real sin(SI.Angle u) of the sin function:

15.3.12 Code Assistance on Identifiers when Hovering

When hovering with the mouse over an identifier a popup with information about the identifier is displayed. If the text is too long, the user can press F2 to focus the popup dialog and scroll up and down to examine all the text. As one can see the information in the popup dialog is syntax-highlighted.

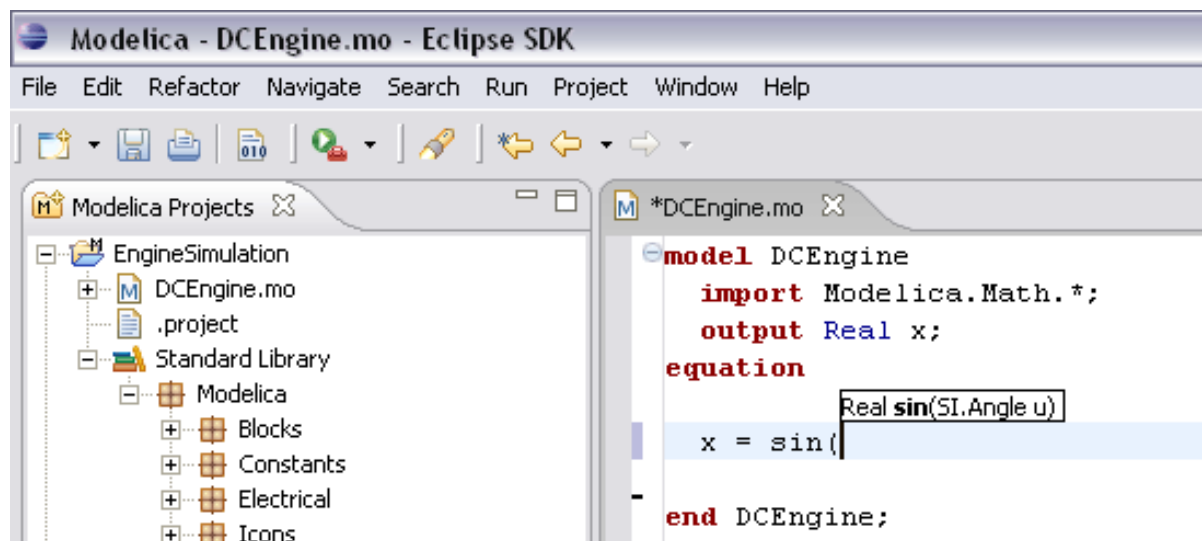

Figure 15.12: Code completion at a function call when typing left parenthesis.

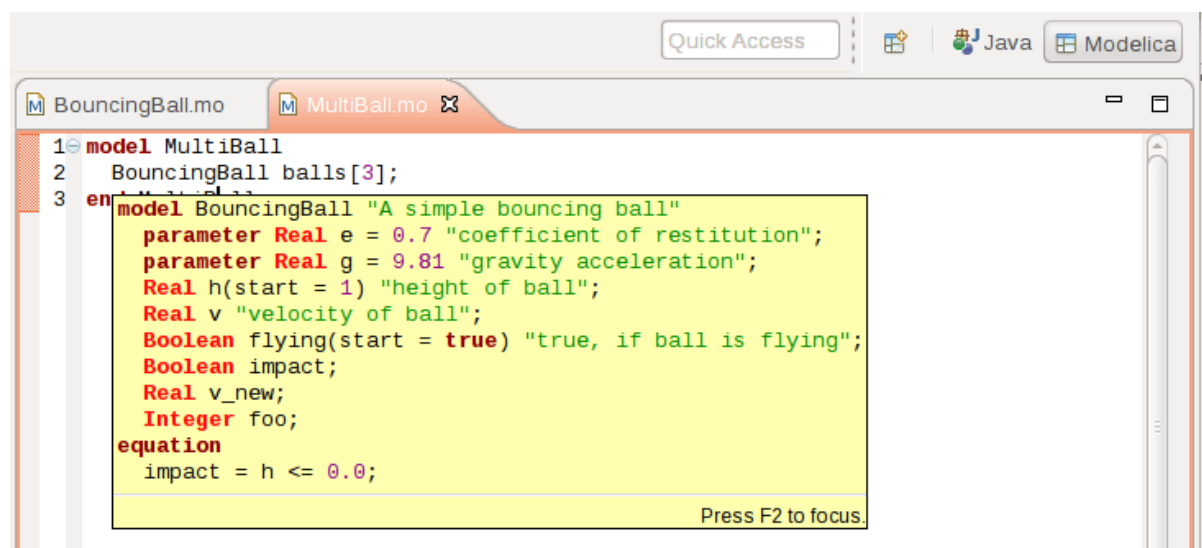

Figure 15.13: Displaying information for identifiers on hovering.

15.3.13 Go to Definition Support

Besides hovering information the user can press CTRL+click to go to the definition of the identifier. When pressing CTRL the identifier will be presented as a link and when pressing mouse click the editor will go to the definition of the identifier.

15.3.14 Code Assistance on Writing Records

When writing records, the same functionality as for function calls is used. This is useful especially in MetaModelica when writing cases in match constructs.

```

6461   end FuncT;
6462   algorithm
6463     outArgs := match outArgs
6464       case FUNCTIONARGS()
6465         algorithm
6466           outArgs.args := list(inFunc(arg, inArg) for arg in outArgs.args);
6467         then
6468           outArgs;
6469       case FOR_ITER_FARG(
6470         algorithm
6471           outArgs.exp := inFunc(outArgs.exp, inArg);
6472           outArgs.iterators := list(traverseExpShallowIterator(it, inArg, inFunc
6473             for it in outArgs.iterators);
6474         then
6475           outArgs;
6476         end match;
6477       end match;
6478     end traverseExpShallowFuncArgs;
6479   end traverseExpShallowFuncArgs;
6480

```

Figure 15.14: Code assistance when writing cases with records in MetaModelica.

15.3.15 Using the MDT Console for Plotting

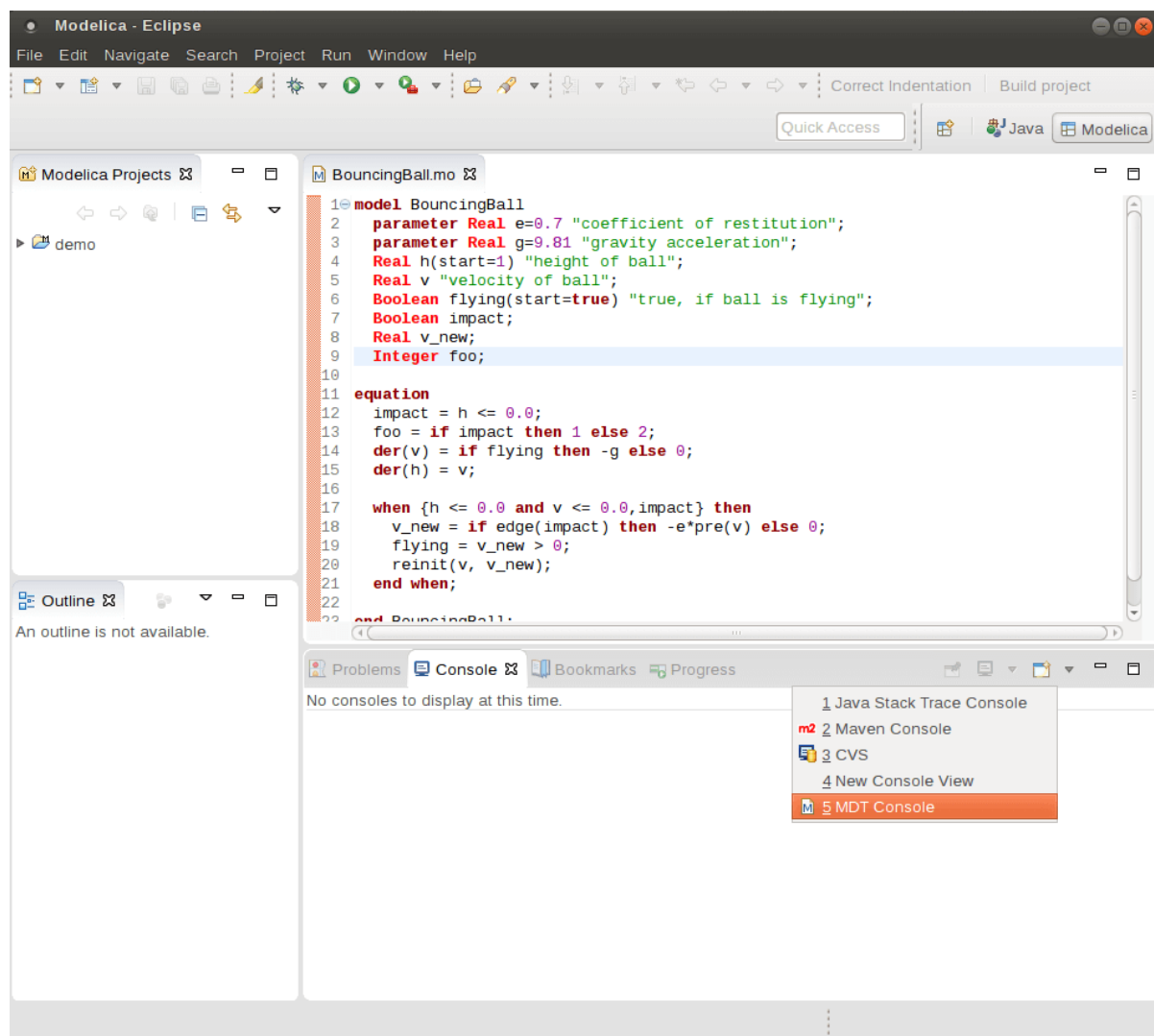

Figure 15.15: Activate the MDT Console.

The screenshot shows the OpenModelica IDE with the following components:

- Modelica Projects:** A tree view on the left showing the project structure, including 'demo', 'BouncingBall.mo', 'VanDerPol.mo', and 'Libraries'.
- Code Editor:** The main window displays the Modelica code for 'BouncingBall.mo'. The code defines parameters for coefficient of restitution ($e=0.7$), gravity ($g=9.81$), and initial height ($h=1$). It uses differential equations to model the ball's velocity (v) and height (h) over time, including logic for impacts.
- OMPLOT:** A window showing a plot of height (h) versus time. The plot shows the ball's trajectory as it bounces and eventually comes to rest.
- Console:** The OpenModelica Console shows the execution of the simulation command `simulate(BouncingBall, stopTime=3.0)` and the resulting simulation statistics.

Figure 15.16: Simulation from MDT Console.

MDT DEBUGGER FOR ALGORITHMIC MODELICA

The algorithmic code debugger, used for the algorithmic subset of the Modelica language as well as the Meta-Modelica language is described in Section *The Eclipse-based Debugger for Algorithmic Modelica*. Using this debugger replaces debugging of algorithmic code by primitive means such as print statements or asserts which is complex, time-consuming and error-prone. The usual debugging functionality found in debuggers for procedural or traditional object-oriented languages is supported, such as setting and removing breakpoints, stepping, inspecting variables, etc. The debugger is integrated with Eclipse.

16.1 The Eclipse-based Debugger for Algorithmic Modelica

The debugging framework for the algorithmic subset of Modelica and MetaModelica is based on the Eclipse environment and is implemented as a set of plugins which are available from Modelica Development Tooling (MDT) environment. Some of the debugger functionality is presented below. In the right part a variable value is explored. In the top-left part the stack trace is presented. In the middle-left part the execution point is presented.

The debugger provides the following general functionalities:

- Adding/Removing breakpoints.
- Step Over – moves to the next line, skipping the function calls.
- Step In – takes the user into the function call.
- **Step Return – complete the execution of the function and takes the** user back to the point from where the function is called.
- Suspend – interrupts the running program.

16.1.1 Starting the Modelica Debugging Perspective

To be able to run in debug mode, one has to go through the following steps:

- create a mos file
- setting the debug configuration
- setting breakpoints
- running the debug configuration

All these steps are presented below using images.

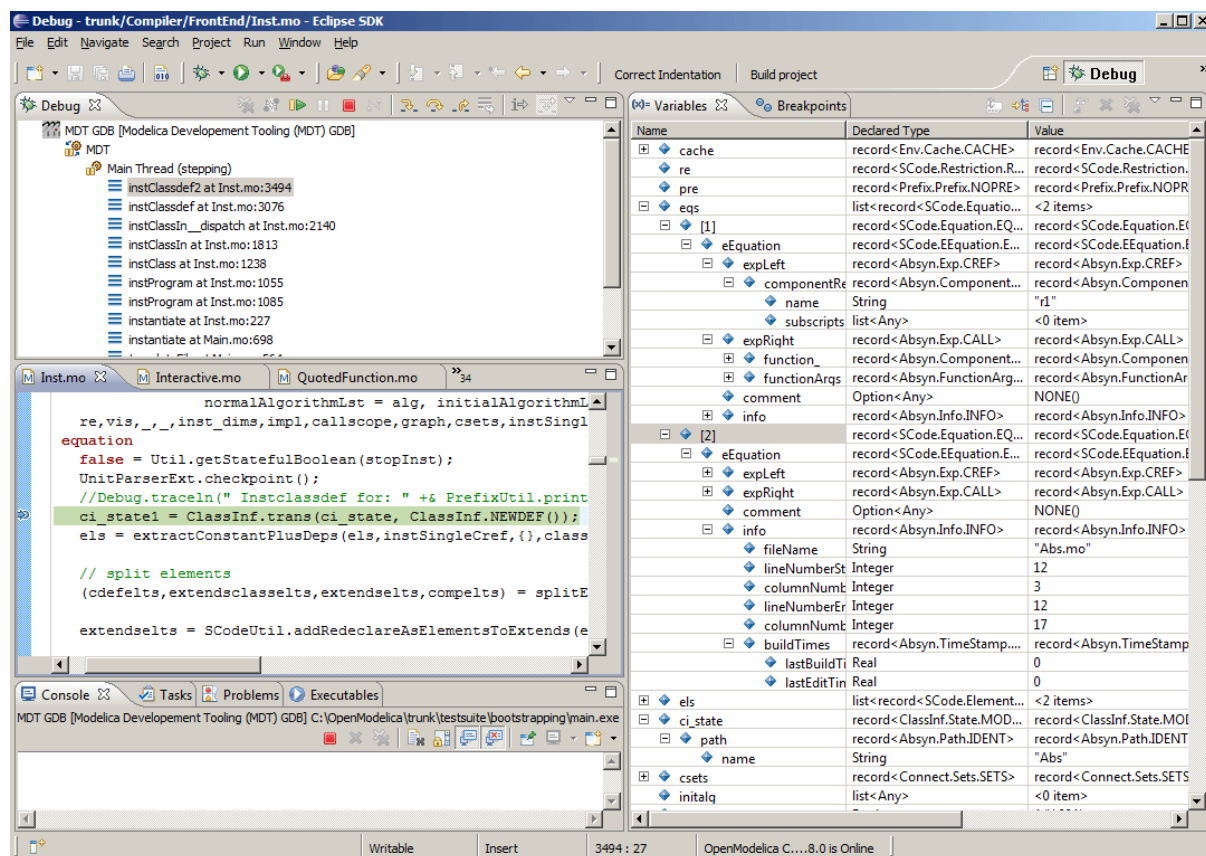

Figure 16.1: Debugging functionality.

Create mos file

In order to debug Modelica code we need to load the Modelica files into the OpenModelica Compiler. For this we can write a small script file like this:

```
function HelloWorld
  input Real r;
  output Real o;
algorithm
  o := 2 * r;
end HelloWorld;
```

```
>>> setCommandLineOptions({"-d=rml,noevalfunc","-g=MetaModelica"})
{true,true}
>>> setCFlags(getCFlags() + " -g")
true
>>> HelloWorld(120.0)
```

So lets say that we want to debug HelloWorld.mo. For that we must load it into the compiler using the script file. Put all the Modelica files there in the script file to be loaded. We should also initiate the debugger by calling the starting function, in the above code HelloWorld(120.0);

Setting the debug configuration

While the Modelica perspective is activated the user should click on the bug icon on the toolbar and select Debug in order to access the dialog for building debug configurations.



Figure 16.2: Accessing the debug configuration dialog.

To create the debug configuration, right click on the classification Modelica Development Tooling (MDT) GDB and select New as in figure below. Then give a name to the configuration, select the debugging executable to be executed and give it command line parameters. There are several tabs in which the user can select additional debug configuration settings like the environment in which the executable should be run.

Note that we require Gnu Debugger (GDB) for debugging session. We must specify the GDB location, also we must pass our script file as an argument to OMC.

Setting/Deleting Breakpoints

The Eclipse interface allows to add/remove breakpoints. At the moment only line number based breakpoints are supported. Other alternative to set the breakpoints is; function breakpoints.

Starting the debugging session and enabling the debug perspective

16.1.2 The Debugging Perspective

The debug view primarily consists of two main views:

- Stack Frames View
- Variables View

The stack frame view, shown in the figure below, shows a list of frames that indicates how the flow had moved from one function to another or from one file to another. This allows backtracing of the code. It is very much possible to select the previous frame in the stack and inspect the values of the variables in that frame. However, it is not possible to select any of the previous frame and start debugging from there. Each frame is shown as <function_name at file_name:line_number>.

The Variables view shows the list of variables at a certain point in the program, containing four columns:

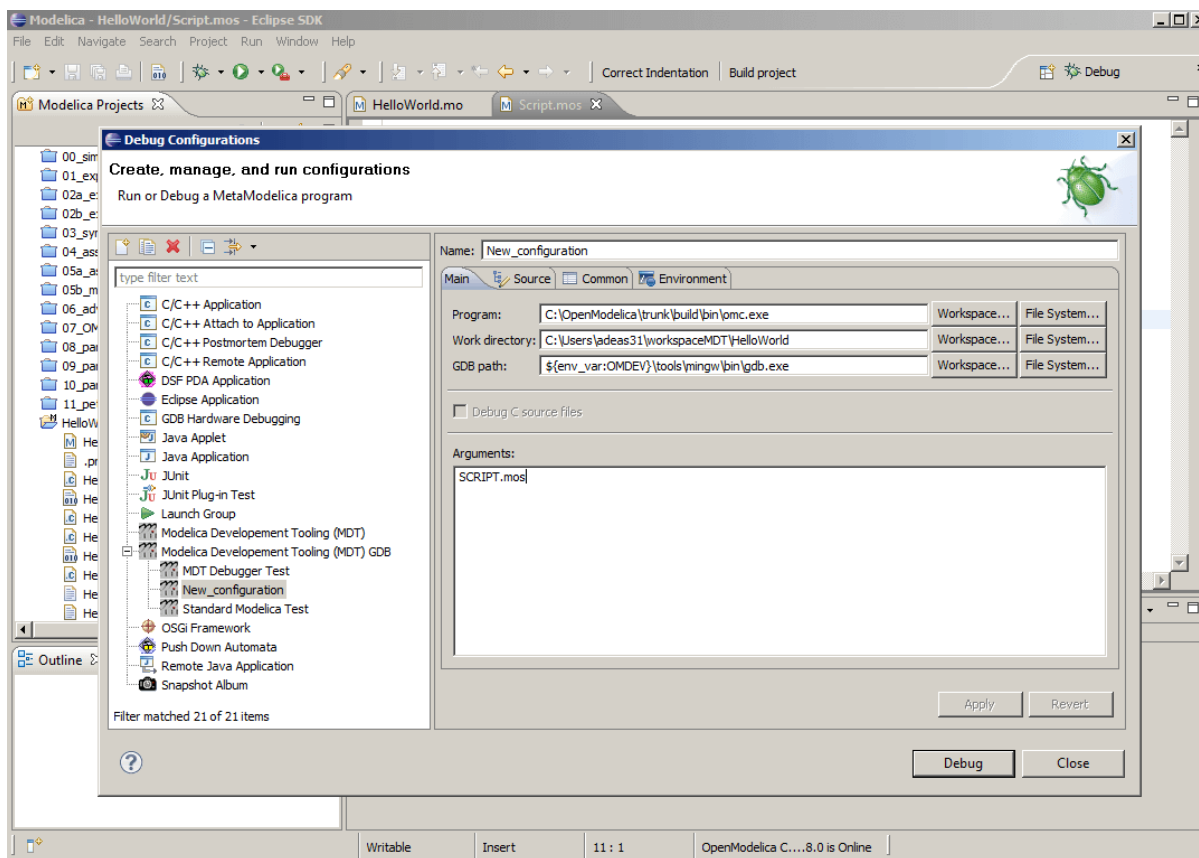

Figure 16.3: Creating the Debug Configuration.

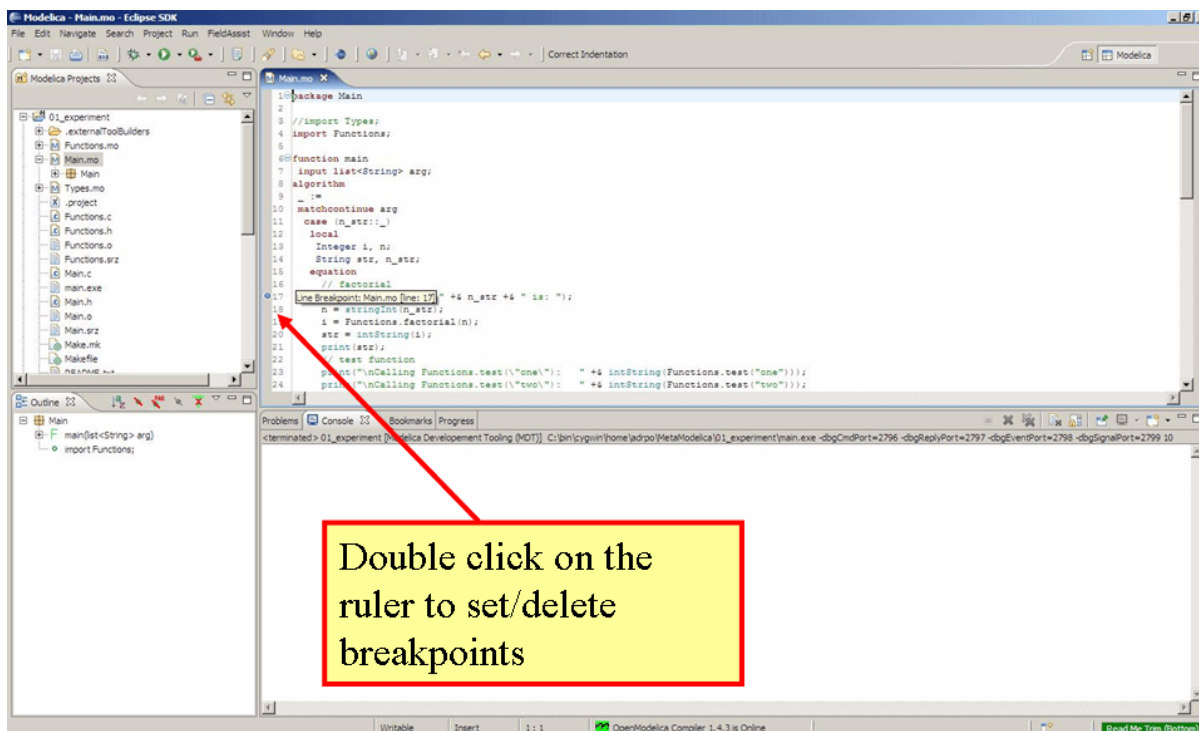

Figure 16.4: Setting/deleting breakpoints.



Figure 16.5: Starting the debugging session.



Figure 16.6: Eclipse will ask if the user wants to switch to the debugging perspective.

- Name – the variable name.
- Declared Type – the Modelica type of the variable.
- Value – the variable value.
- Actual Type – the mapped C type.

By preserving the stack frames and variables it is possible to keep track of the variables values. If the value of any variable is changed while stepping then that variable will be highlighted yellow (the standard Eclipse way of showing the change).



Figure 16.7: The debugging perspective.



Figure 16.8: Switching between perspectives.

MODELICA PERFORMANCE ANALYZER

A common problem when simulating models in an equation-based language like Modelica is that the model may contain non-linear equation systems. These are solved in each time-step by extrapolating an initial guess and running a non-linear system solver. If the simulation takes too long to simulate, it is useful to run the performance analysis tool. The tool has around 5~25% overhead, which is very low compared to instruction-level profilers (30x-100x overhead). Due to being based on a single simulation run, the report may contain spikes in the charts.

When running a simulation for performance analysis, execution times of user-defined functions as well as linear, non-linear and mixed equation systems are recorded.

To start a simulation in this mode, turn on profiling with the following command line flag >>> setCommandLineOptions("--profiling=all")

The generated report is in HTML format (with images in the SVG format), stored in a file modelname_prof.html, but the XML database and measured times that generated the report and graphs are also available if you want to customize the report for comparison with other tools.

Below we use the performance profiler on the simple model A:

```
model ProfilingTest
  function f
    input Real r;
    output Real o = sin(r);
  end f;
  String s = "abc";
  Real x = f(x) "This is x";
  Real y(start=1);
  Real z1 = cos(z2);
  Real z2 = sin(z1);
equation
  der(y) = time;
end ProfilingTest;
```

We simulate as usual, after setting the profiling flag:

```
>>> setCommandLineOptions("--profiling=blocks+html")
true
>>> simulate(ProfilingTest)
record SimulationResult
  resultFile = "«DOCHOME»/ProfilingTest_res.mat",
  simulationOptions = "startTime = 0.0, stopTime = 1.0, numberOfIntervals = 500,
↳tolerance = 1e-06, method = 'dassl', fileNamePrefix = 'ProfilingTest', options =
↳'', outputFormat = 'mat', variableFilter = '.*', cflags = '', simflags = '',
  messages = "LOG_SUCCESS      | info      | The initialization finished,
↳successfully without homotopy method.
LOG_SUCCESS      | info      | The simulation finished successfully.
Warning: empty y range [3:3], adjusting to [2.97:3.03]
Warning: empty y range [3:3], adjusting to [2.97:3.03]
Warning: empty y range [2:2], adjusting to [1.98:2.02]
Warning: empty y range [2:2], adjusting to [1.98:2.02]
Warning: empty y range [3:3], adjusting to [2.97:3.03]
```

(continues on next page)

(continued from previous page)

```

Warning: empty y range [3:3], adjusting to [2.97:3.03]
stdout      | info      | Time measurements are stored in ProfilingTest_prof.
↳html (human-readable) and ProfilingTest_prof.xml (for XSL transforms or more_
↳details)
",
  timeFrontend = 0.011648164,
  timeBackend = 0.013868492,
  timeSimCode = 0.001200092,
  timeTemplates = 0.003508556,
  timeCompile = 0.426298967,
  timeSimulation = 0.06854568400000001,
  timeTotal = 0.525164033
end SimulationResult;
"Warning: There are nonlinear iteration variables with default zero start_
↳attribute found in NLSJac0. For more information set -d=initialization. In_
↳OMEdit Tools->Options->Simulation->OMCFlags, in OMNotebook call_
↳setCommandLineOptions("\-d=initialization\").
Warning: The initial conditions are not fully specified. For more information set -
↳d=initialization. In OMEdit Tools->Options->Simulation->OMCFlags, in OMNotebook_
↳call setCommandLineOptions("\-d=initialization\").
"

```

17.1 Profiling information for ProfilingTest

17.1.1 Information

All times are measured using a real-time wall clock. This means context switching produces bad worst-case execution times (max times) for blocks. If you want better results, use a CPU-time clock or run the command using real-time privileges (avoiding context switches).

Note that for blocks where the individual execution time is close to the accuracy of the real-time clock, the maximum measured time may deviate a lot from the average.

For more details, see [ProfilingTest_prof.xml](#).

17.1.2 Settings

Name	Value
Integration method	dassl
Output format	mat
Output name	ProfilingTest_res.mat
Output size	24.0 kB
Profiling data	ProfilingTest_prof.data
Profiling size	0 B

17.1.3 Summary

Task	Time	Fraction
Pre-Initialization	0.000155	1.61%
Initialization	0.000194	2.02%
Event-handling	0.000000	0.00%
Creating output file	0.000608	6.33%
Linearization		NaN%
Time steps	0.007500	78.07%
Overhead	0.000279	2.90%
Unknown	NaN	NaN%
Total simulation time	0.009607	100.00%

17.1.4 Global Steps

	Steps	Total Time	Fraction	Average Time	Max Time	Deviation
	499	0.007500	78.07%	0.000015030060 1202405	0.000139140	8.26x

17.1.5 Measured Function Calls

	Name	Calls	Time	Fraction	Max Time	Deviation
	<i>ProfilingTest.f</i>	1512	0.000261512	2.72%	0.000003245	17.76x

17.1.6 Measured Blocks

	Name	Calls	Time	Fraction	Max Time	Deviation
	<code><#eq0>_</code>	7	0.000104177	1.08%	0.000105386	6.08x
	<code><#eq12>_</code>	4	0.000006788	0.07%	0.000007392	3.36x
	<code><#eq20>_</code>	1006	0.001459929	15.20%	0.000019405	12.37x
	<code><#eq22>_</code>	1508	0.002363927	24.61%	0.000019865	11.67x

Equations

Name	Variables
eq0	
eq1	y
eq2	s
eq3	
eq4	$z2$
eq5	
eq6	`<#var0>`__
eq7	`<#var0>`__
eq8	`<#var0>`__
eq9	`<#var0>`__
eq10	$z1$
eq11	
eq12	x
eq13	$der(y)$
eq14	$z2$
eq15	
eq16	`<#var0>`__
eq17	`<#var0>`__
eq18	`<#var0>`__
eq19	`<#var0>`__
eq20	$z1$
eq21	
eq22	x
eq23	

Variables

Name	Comment
y	
$der(y)$	
x	This is x
$z1$	
$z2$	
s	

This report was generated by [OpenModelica](#) on 2020-10-14 07:10:06.

17.2 Generated JSON for the Example

Listing 17.1: ProfilingTest_prof.json

```
{
  "name": "ProfilingTest",
  "prefix": "ProfilingTest",
  "date": "2020-10-14 07:10:06",
  "method": "dassl",
  "outputFormat": "mat",
  "outputFilename": "ProfilingTest_res.mat",
```

(continues on next page)

(continued from previous page)

```

"outputFileSize":24581,
"overheadTime":0.000330128,
"preinitTime":0.000154779,
"initTime":0.000193662,
"eventTime":0,
"outputTime":0.000608269,
"jacobianTime":5.02731e-05,
"totalTime":0.00960672,
"totalStepsTime":1.19514e-05,
"totalTimeProfileBlocks":0.00393482,
"numStep":499,
"maxTime":0.000139140394,
"functions": [
{"name": "ProfilingTest.f", "ncall":1512, "time":0.000261512, "maxTime":0.000003245}
],
"profileBlocks": [
{"id":0, "ncall":7, "time":0.000104177, "maxTime":0.000105386},
{"id":12, "ncall":4, "time":0.000006788, "maxTime":0.000007392},
{"id":20, "ncall":1006, "time":0.001459929, "maxTime":0.000019405},
{"id":22, "ncall":1508, "time":0.002363927, "maxTime":0.000019865}
]
}

```

17.3 Using the Profiler from OMEdit

When running a simulation from OMEdit, it is possible to enable profiling information, which can be combined with the *transformations browser*.



Figure 17.1: Setting up the profiler from OMEdit.

When profiling the DoublePendulum example from MSL, the following output in Figure 17.2 is a typical result.

This information clearly shows which system takes longest to simulate (a linear system, where most of the time overhead probably comes from initializing LAPACK over and over).

Equations Browser							Defines
Index	Type	Equation	Executions	Max time	Time	Fraction	Variable
+ 876	regular	linear, size 2	4602	0.000199	0.0582	86.2%	
- 836	regular	(assignment) revolute2.R_rel.T[2,2] = cos(revolute2.phi)	1534	8.25e-05	0.000491	0.728%	damper.a_rel
- 837	regular	(assignment) revolute2.R_rel.T[2,1] = -sin(revolute2.phi)	1534	7.29e-05	0.000422	0.625%	revolute2.frame_b.f[2]
- 841	regular	(assignment) boxBody1.frame_...[2,1] = -sin(damper.phi_rel)	1534	7.1e-05	0.000395	0.585%	
- 840	regular	(assignment) boxBody1.frame_...T[2,2] = cos(damper.phi_rel)	1534	7.08e-05	0.000361	0.535%	
- 839	regular	(assignment) revolute2.R_rel.T[1,1] = cos(revolute2.phi)	1534	7.33e-05	0.000303	0.449%	
- 842	regular	(assignment) boxBody1.frame_b.R.T[1,2] = sin(damper.phi_rel)	1534	7.45e-05	0.000303	0.449%	
- 838	regular	(assignment) revolute2.R_rel.T[1,2] = sin(revolute2.phi)	1534	7.11e-05	0.0003	0.444%	
- 849	regular	(assignment) boxBody1.frame_...T[1,1] = cos(damper.phi_rel)	1534	7.29e-05	0.000286	0.424%	
- 827	regular	(assignment) revolute1.tau = (-damper.d) * revolute1.w	1534	6.84e-05	0.000274	0.406%	

Figure 17.2: Profiling results of the Modelica standard library DoublePendulum example, sorted by execution time.

SIMULATION IN WEB BROWSER

OpenModelica can simulate in a web browser on a client computer by model code being compiled to efficient Javascript code.

For more information, see <https://github.com/tshort/openmodelica-javascript>

Below used on the MSL MultiBody RobotR3.fullRobot example model.

The screenshot shows a web browser window with the URL `http://tshort.github.io/mdpad/mdpad.html?Modelica`. The page title is "OpenModelica simulation example" and the model name is "Modelica.Mechanics.MultiBody.Examples.Systems.RobotR3.fullRobot". The simulation status is "Simulation finished. Time: 00:40".

On the left side, there are three input fields for simulation parameters:

- Stop time, sec: 1.8
- Output intervals: 500
- Tolerance: 0.0001

The main content area is divided into two tabs: "Model" and "Results". The "Model" tab is active, showing a block diagram of the robot arm model. The diagram consists of a central "control" block connected to six "motor" blocks, which are in turn connected to a "robot" block. The "robot" block contains a 3D model of the robot arm.

Below the diagram, there is a "Comments" section with the following text:

This simulation model is from a [Modelica](#) model. Modelica is a language for simulating electrical, thermal, and mechanical systems. [OpenModelica](#) was used to compile this model to C. Then, [Emscripten](#) was used to compile the C code to JavaScript. For more information on compiling OpenModelica to JavaScript, see [here](#).

The user interface was created in [mdpad](#). See [Modelica.Mechanics.MultiBody.Examples.Systems.RobotR3.fullRobot.md](#) for the Markdown code for this page.



INTEROPERABILITY – C AND PYTHON

Below is information and examples about the OpenModelica external C interfaces, as well as examples of Python interoperability.

19.1 Calling External C functions

The following is a small example (ExternalLibraries.mo) to show the use of external C functions:

```
model ExternalLibraries

  function ExternalFunc1
    input Real x;
    output Real y;
    external y=ExternalFunc1_ext(x) annotation(Library="ExternalFunc1.o",
↪LibraryDirectory="modelica://ExternalLibraries", Include="#include \
↪"ExternalFunc1.h\"");
  end ExternalFunc1;

  function ExternalFunc2
    input Real x;
    output Real y;
    external "C" annotation(Library="ExternalFunc2", LibraryDirectory="modelica://
↪ExternalLibraries");
  end ExternalFunc2;

  Real x(start=1.0, fixed=true), y(start=2.0, fixed=true);
equation
  der(x)=-ExternalFunc1(x);
  der(y)=-ExternalFunc2(y);
end ExternalLibraries;
```

These C (.c) files and header files (.h) are needed (note that the headers are not needed since OpenModelica will generate the correct definition if it is not present; using the headers it is possible to write C-code directly in the Modelica source code or declare non-standard calling conventions):

Listing 19.1: ExternalFunc1.c

```
double ExternalFunc1_ext(double x)
{
  double res;
  res = x+2.0*x*x;
  return res;
}
```

Listing 19.2: ExternalFunc1.h

```
double ExternalFunc1_ext(double);
```

Listing 19.3: ExternalFunc2.c

```
double ExternalFunc2(double x)
{
  double res;
  res = (x-1.0)*(x+2.0);
  return res;
}
```

The following script file ExternalLibraries.mos will perform everything that is needed, provided you have gcc installed in your path:

```
>>> system(getCompiler() + " -c -o ExternalFunc1.o ExternalFunc1.c")
0
>>> system(getCompiler() + " -c -o ExternalFunc2.o ExternalFunc2.c")
0
>>> system("ar rcs libExternalFunc2.a ExternalFunc2.o")
0
>>> simulate(ExternalLibraries)
record SimulationResult
  resultFile = "«DOCHOME»/ExternalLibraries_res.mat",
  simulationOptions = "startTime = 0.0, stopTime = 1.0, numberOfIntervals = 500,
↳tolerance = 1e-06, method = 'dassl', fileNamePrefix = 'ExternalLibraries',
↳options = '', outputFormat = 'mat', variableFilter = '.*', cflags = '', simflags_
↳= '',
  messages = "LOG_SUCCESS      | info      | The initialization finished_
↳successfully without homotopy method.
LOG_SUCCESS      | info      | The simulation finished successfully.
",
  timeFrontend = 0.013143431,
  timeBackend = 0.001739876,
  timeSimCode = 0.000573747,
  timeTemplates = 0.003257034,
  timeCompile = 0.409722723,
  timeSimulation = 0.022992027,
  timeTotal = 0.451549303
end SimulationResult;
```

And plot the results:

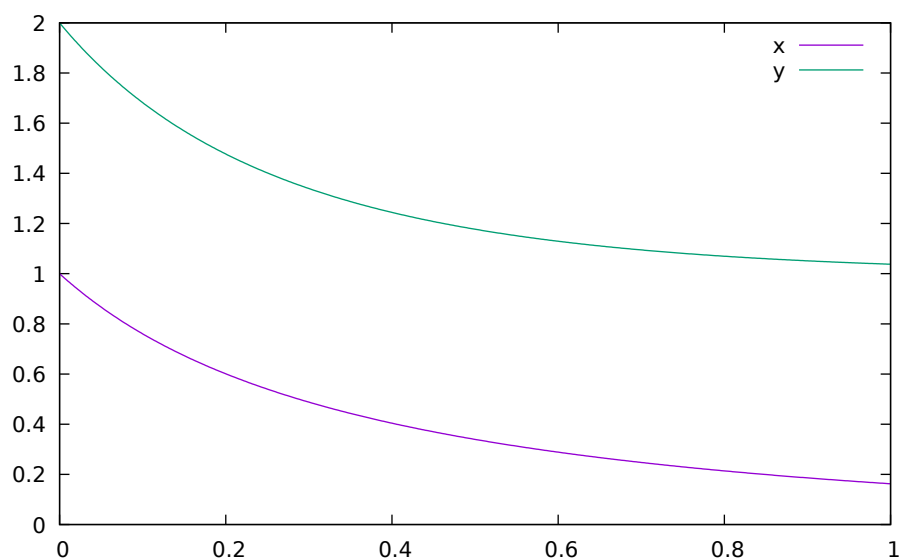

Figure 19.1: Plot generated by OpenModelica+gnuplot

19.2 Calling external Python Code from a Modelica model

The following calls external Python code through a very simplistic external function (no data is retrieved from the Python code). By making it a dynamically linked library, you might get the code to work without changing the linker settings.

```

function pyRunString
  input String s;
external "C" annotation(Include="
#include <Python.h>

void pyRunString(const char *str)
{
  Py_SetProgramName("\pyRunString\"); /* optional but recommended */
  Py_Initialize();
  PyRun_SimpleString(str);
  Py_Finalize();
}
");
end pyRunString;

model CallExternalPython
algorithm
  pyRunString("
print 'Python says: simulation time'," +String(time)+"
");
end CallExternalPython;

```

```

>>> system("python-config --cflags > pycflags")
0
>>> system("python-config --ldflags > pyldflags")
0
>>> pycflags := stringReplace(readFile("pycflags"), "\n", "");
>>> pyldflags := stringReplace(readFile("pyldflags"), "\n", "");
>>> setCFlags(getCFlags()+pycflags)
true
>>> setLinkerFlags(getLinkerFlags()+pyldflags)
true
>>> simulate(CallExternalPython, stopTime=2)
record SimulationResult
  resultFile = "«DOCHOME»/CallExternalPython_res.mat",
  simulationOptions = "startTime = 0.0, stopTime = 2.0, numberOfIntervals = 500,
↳tolerance = 1e-06, method = 'dassl', fileNamePrefix = 'CallExternalPython',
↳options = '', outputFormat = 'mat', variableFilter = '.', cflags = '', simflags_
↳= '',
  messages = "Python says: simulation time 0
Python says: simulation time 0
LOG_SUCCESS      | info      | The initialization finished successfully without_
↳homotopy method.
Python says: simulation time 2
LOG_SUCCESS      | info      | The simulation finished successfully.
",
  timeFrontend = 0.010973398,
  timeBackend = 0.002262147,
  timeSimCode = 0.007632045,
  timeTemplates = 0.002890506,
  timeCompile = 0.5183897470000001,
  timeSimulation = 0.038345407,
  timeTotal = 0.580633882
end SimulationResult;

```

19.3 Calling OpenModelica from Python Code

This section describes a simple-minded approach to calling Python code from OpenModelica. For a description of Python scripting with OpenModelica, see *OMPpython – OpenModelica Python Interface*.

The interaction with Python can be performed in four different ways whereas one is illustrated below. Assume that we have the following Modelica code:

Listing 19.4: CalledbyPython.mo

```
model CalledbyPython
  Real x(start=1.0), y(start=2.0);
  parameter Real b = 2.0;
equation
  der(x) = -b*y;
  der(y) = x;
end CalledbyPython;
```

In the following Python (.py) files the above Modelica model is simulated via the OpenModelica scripting interface:

Listing 19.5: PythonCaller.py

```
#!/usr/bin/python
import sys,os
global newb = 0.5
execfile('CreateMosFile.py')
os.popen(r"omc CalledbyPython.mos").read()
execfile('RetrResult.py')
```

Listing 19.6: CreateMosFile.py

```
#!/usr/bin/python
mos_file = open('CalledbyPython.mos','w', 1)
mos_file.write('loadFile("CalledbyPython.mo");\n')
mos_file.write('setComponentModifierValue(CalledbyPython,b,$Code(="+str(newb)+")); \n')
mos_file.write('simulate(CalledbyPython,stopTime=10);\n')
mos_file.close()
```

Listing 19.7: RetrResult.py

```
#!/usr/bin/python
def zeros(n): #
  vec = [0.0]
  for i in range(int(n)-1): vec = vec + [0.0]
  return vec
res_file = open("CalledbyPython_res.plt",'r',1)
line = res_file.readline()
size = int(res_file.readline().split('=')[1])
time = zeros(size)
y = zeros(size)
while line != ['DataSet: time\n']:
  line = res_file.readline().split(',')[0:1]
for j in range(int(size)):
  time[j]=float(res_file.readline().split(',')[0])
while line != ['DataSet: y\n']:
  line=res_file.readline().split(',')[0:1]
for j in range(int(size)):
  y[j]=float(res_file.readline().split(',')[1])
res_file.close()
```

A second option of simulating the above Modelica model is to use the command `buildModel` instead of the `simulate` command and setting the parameter value in the initial parameter file, `CalledbyPython_init.txt` instead of using the command `setComponentModifierValue`. Then the file `CalledbyPython.exe` is just executed.

The third option is to use the Corba interface for invoking the compiler and then just use the scripting interface to send commands to the compiler via this interface.

The fourth variant is to use external function calls to directly communicate with the executing simulation process.

OPENMODELICA PYTHON INTERFACE AND PYSIMULATOR

This chapter describes the OpenModelica Python integration facilities.

- OMPython – the OpenModelica Python scripting interface, see *OMPython – OpenModelica Python Interface*.
- EnhancedOMPython - Enhanced OMPython scripting interface, see *Enhanced OMPython Features*.
- PySimulator – a Python package that provides simulation and post processing/analysis tools integrated with OpenModelica, see *PySimulator*.

20.1 OMPython – OpenModelica Python Interface

OMPython – OpenModelica Python API is a free, open source, highly portable Python based interactive session handler for Modelica scripting. It provides the modeler with components for creating a complete Modelica modeling, compilation and simulation environment based on the latest OpenModelica library standard available. OMPython is architected to combine both the solving strategy and model building. So domain experts (people writing the models) and computational engineers (people writing the solver code) can work on one unified tool that is industrially viable for optimization of Modelica models, while offering a flexible platform for algorithm development and research. OMPython is not a standalone package, it depends upon the OpenModelica installation.

OMPython is implemented in Python and depends either on the OmniORB and OmniORBpy - high performance CORBA ORBs for Python or ZeroMQ - high performance asynchronous messaging library and it supports the Modelica Standard Library version 3.2 that is included in starting with OpenModelica 1.9.2.

To install OMPython follow the instructions at <https://github.com/OpenModelica/OMPython>

20.1.1 Features of OMPython

OMPython provides user friendly features like:

- Interactive session handling, parsing, interpretation of commands and Modelica expressions for evaluation, simulation, plotting, etc.
- Interface to the latest OpenModelica API calls.
- Optimized parser results that give control over every element of the output.
- Helper functions to allow manipulation on Nested dictionaries.
- Easy access to the library and testing of OpenModelica commands.

20.1.2 Test Commands

OMPython provides two classes for communicating with OpenModelica i.e., `OMCSession` and `OMCSessionZMQ`. Both classes have the same interface, the only difference is that `OMCSession` uses `omniORB` and `OMCSessionZMQ` uses `ZeroMQ`. All the examples listed down uses `OMCSessionZMQ` but if you want to test `OMCSession` simply replace `OMCSessionZMQ` with `OMCSession`. We recommend to use `OMCSessionZMQ`.

To test the command outputs, simply create an `OMCSessionZMQ` object by importing from the `OMPython` library within Python interpreter. The module allows you to interactively send commands to the OMC server and display their output.

To get started, create an `OMCSessionZMQ` object:

```
>>> from OMPython import OMCSessionZMQ
>>> omc = OMCSessionZMQ()
```

```
>>> omc.sendExpression("getVersion() ")
OMCCompiler v1.16.0-dev.beta3.22+gfeadc57b32
>>> omc.sendExpression("cd() ")
«DOCHOME»
>>> omc.sendExpression("loadModel(Modelica) ")
True
>>> omc.sendExpression("loadFile(getInstallationDirectoryPath() + \" /share/doc/omc/
↳testmodels/BouncingBall.mo\") ")
True
>>> omc.sendExpression("instantiateModel(BouncingBall) ")
class BouncingBall
  parameter Real e = 0.7 "coefficient of restitution";
  parameter Real g = 9.81 "gravity acceleration";
  Real h(start = 1.0, fixed = true) "height of ball";
  Real v(fixed = true) "velocity of ball";
  Boolean flying(start = true, fixed = true) "true, if ball is flying";
  Boolean impact;
  Real v_new(fixed = true);
  Integer foo;
equation
  impact = h <= 0.0;
  foo = if impact then 1 else 2;
  der(v) = if flying then -g else 0.0;
  der(h) = v;
  when {h <= 0.0 and v <= 0.0, impact} then
    v_new = if edge(impact) then (-e) * pre(v) else 0.0;
    flying = v_new > 0.0;
    reinit(v, v_new);
  end when;
end BouncingBall;
```

We get the name and other properties of a class:

```
>>> omc.sendExpression("getClassNames() ")
('BouncingBall', 'ModelicaServices', 'Complex', 'Modelica')
>>> omc.sendExpression("isPartial(BouncingBall) ")
False
>>> omc.sendExpression("isPackage(BouncingBall) ")
False
>>> omc.sendExpression("isModel(BouncingBall) ")
True
>>> omc.sendExpression("checkModel(BouncingBall) ")
Check of BouncingBall completed successfully.
Class BouncingBall has 6 equation(s) and 6 variable(s).
1 of these are trivial equation(s).
>>> omc.sendExpression("getClassRestriction(BouncingBall) ")
model
```

(continues on next page)

(continued from previous page)

```

>>> omc.sendExpression("getClassInformation(BouncingBall) ")
('model', '', False, False, False, '/var/lib/jenkins2/ws/OpenModelica_maintenance_
↪v1.16/build/share/doc/omc/testmodels/BouncingBall.mo', False, 1, 1, 23, 17, (),
↪False, False, '', '', False, '')
>>> omc.sendExpression("getConnectionCount(BouncingBall) ")
0
>>> omc.sendExpression("getInheritanceCount(BouncingBall) ")
0
>>> omc.sendExpression("getComponentModifierValue(BouncingBall,e) ")
0.7
>>> omc.sendExpression("checkSettings()")
{'OPENMODELICAHOME': '«DOCHOME»', 'OPENMODELICALIBRARY':
↪'«OPENMODELICAHOME»/lib/omlibrary', 'OMC_PATH': '«OPENMODELICAHOME»/bin/omc',
↪'SYSTEM_PATH': '/var/lib/jenkins2/ws/OpenModelica_maintenance_v1.16/doc/
↪UsersGuide/../../../../build//bin:/usr/local/sbin:/usr/local/bin:/usr/sbin:/usr/bin:/
↪sbin:/bin', 'OMDEV_PATH': '', 'OMC_FOUND': True, 'MODELICAUSERCFLAGS': '',
↪'WORKING_DIRECTORY': '«DOCHOME»', 'CREATE_FILE_WORKS': True, 'REMOVE_FILE_WORKS
↪': True, 'OS': 'linux', 'SYSTEM_INFO': 'Linux 303951c0b69c 4.15.0-72-generic #81-
↪Ubuntu SMP Tue Nov 26 12:20:02 UTC 2019 x86_64 x86_64 x86_64 GNU/Linux\n',
↪'RTLIBS': ' -Wl,--no-as-needed -Wl,--disable-new-dtags -lOpenModelicaRuntimeC -
↪llapack -lblas -lm -lomcgc -lpthread -rdynamic', 'C_COMPILER': 'clang', 'C_
↪COMPILER_VERSION': 'clang version 6.0.0-1ubuntu2 (tags/RELEASE_600/final)\
↪nTarget: x86_64-pc-linux-gnu\nThread model: posix\nInstalledDir: /usr/bin\n', 'C_
↪COMPILER_RESPONDING': True, 'HAVE_CORBA': True, 'CONFIGURE_CMDLINE': "Configured
↪2020-10-14 06:54:29 using arguments: '--disable-option-checking' '--prefix=/var/
↪lib/jenkins1/ws/OpenModelica_maintenance_v1.16/build' 'CC=clang' 'CXX=clang++'
↪'FC=gfortran' 'CFLAGS=-Os' '--with-cppruntime' '--without-omc' '--without-
↪omlibrary' '--with-omniORB' '--enable-modelica3d' '--without-hwloc' '--with-
↪ombuilddir=/var/lib/jenkins1/ws/OpenModelica_maintenance_v1.16/build' '--cache-
↪file=/dev/null' '--srcdir=."}

```

The common combination of a simulation followed by getting a value and doing a plot:

```

>>> omc.sendExpression("simulate(BouncingBall, stopTime=3.0) ")
{'resultFile': '«DOCHOME»/BouncingBall_res.mat', 'simulationOptions': "startTime =
↪0.0, stopTime = 3.0, numberOfIntervals = 500, tolerance = 1e-06, method = 'dassl
↪', fileNamePrefix = 'BouncingBall', options = '', outputFormat = 'mat',
↪variableFilter = '.*', cflags = '', simflags = '', 'messages': 'LOG_SUCCESS
↪ | info | The initialization finished successfully without homotopy method.\
↪nLOG_SUCCESS | info | The simulation finished successfully.\n',
↪'timeFrontend': 0.337033471, 'timeBackend': 0.003614184, 'timeSimCode': 0.
↪001113289, 'timeTemplates': 0.003487026, 'timeCompile': 0.442770756,
↪'timeSimulation': 0.021122198, 'timeTotal': 0.8092820970000001}
>>> omc.sendExpression("val(h , 2.0) ")
0.04239430772884106

```

Import As Library

To use the module from within another python program, simply import OMCSessionZMQ from within the using program.

For example:

```

# test.py
from OMPython import OMCSessionZMQ
omc = OMCSessionZMQ()
cmds = [
    'loadFile(getInstallationDirectoryPath() + "/share/doc/omc/testmodels/
↪BouncingBall.mo")',
    "simulate(BouncingBall)",

```

(continues on next page)

(continued from previous page)

```

"plot(h) "
]
for cmd in cmds:
    answer = omc.sendExpression(cmd)
    print("\n{}:\n{}".format(cmd, answer))

```

20.1.3 Implementation

Client Implementation

The OpenModelica Python API Interface – OMPython, attempts to mimic the OMSHELL's style of operations.

OMPython is designed to,

- Initialize the CORBA/ZeroMQ communication.
- Send commands to the OMC server via the CORBA/ZeroMQ interface.
- Receive the string results.
- Use the Parser module to format the results.
- Return or display the results.

20.2 Enhanced OMPython Features

Some more improvements are added to OMPython functionality for querying more information about the models and simulate them. A list of new user friendly API functionality allows user to extract information about models using python objects. A list of API functionality is described below.

To get started, create a ModelicaSystem object:

```

>>> from OMPython import OMCSessionZMQ
>>> omc = OMCSessionZMQ()
>>> model_path=omc.sendExpression("getInstallationDirectoryPath()") + "/share/doc/
↳omc/testmodels/"
>>> from OMPython import ModelicaSystem
>>> mod=ModelicaSystem(model_path + "BouncingBall.mo", "BouncingBall")

```

The object constructor requires a minimum of 2 input arguments which are strings, and may need a third string input argument.

- The first input argument must be a string with the file name of the Modelica code, with Modelica file extension ".mo". If the Modelica file is not in the current directory of Python, then the file path must also be included.
- The second input argument must be a string with the name of the Modelica model including the namespace if the model is wrapped within a Modelica package.
- The third input argument (optional) is used to specify the list of dependent libraries or dependent Modelica files e.g.,

```

>>> mod=ModelicaSystem(model_path + "BouncingBall.mo", "BouncingBall", ["Modelica"])

```

- The fourth input argument (optional), is a keyword argument which is used to set the command line options e.g.,

```

>>> mod=ModelicaSystem(model_path + "BouncingBall.mo", "BouncingBall",
↳commandLineOptions="-d=newInst")

```

- By default ModelicaSystem uses OMCSessionZMQ but if you want to use OMCSession then pass the argument *useCorba=True* to the constructor.

20.2.1 BuildModel

The buildModel API can be used after ModelicaSystem(), in case the model needs to be updated or additional simulationflags needs to be set using sendExpression()

```
>>> mod.buildModel()
```

20.2.2 Standard get methods

- getQuantities()
- getContinuous()
- getInputs()
- getOutputs()
- getParameters()
- getSimulationOptions()
- getSolutions()

Three calling possibilities are accepted using getXXX() where "XXX" can be any of the above functions (eg:) getParameters().

- getXXX() without input argument, returns a dictionary with names as keys and values as values.
- getXXX(S), where S is a string of names.
- getXXX(["S1","S2"]) where S1 and S1 are list of string elements

20.2.3 Usage of getMethods

```
>>> mod.getQuantities() // method-1, list of all variables from xml file
[{'aliasvariable': None, 'Name': 'height', 'Variability': 'continuous', 'Value':
↳ '1.0', 'alias': 'noAlias', 'Changeable': 'true', 'Description': None}, {
↳ 'aliasvariable': None, 'Name': 'c', 'Variability': 'parameter', 'Value': '0.9',
↳ 'alias': 'noAlias', 'Changeable': 'true', 'Description': None}]
```

```
>>> mod.getQuantities("height") // method-2, to query information about single_
↳ quantity
[{'aliasvariable': None, 'Name': 'height', 'Variability': 'continuous', 'Value':
↳ '1.0', 'alias': 'noAlias', 'Changeable': 'true', 'Description': None}]
```

```
>>> mod.getQuantities(["c","radius"]) // method-3, to query information about list_
↳ of quantity
[{'aliasvariable': None, 'Name': 'c', 'Variability': 'parameter', 'Value': '0.9',
↳ 'alias': 'noAlias', 'Changeable': 'true', 'Description': None}, {'aliasvariable
↳ ': None, 'Name': 'radius', 'Variability': 'parameter', 'Value': '0.1', 'alias':
↳ 'noAlias', 'Changeable': 'true', 'Description': None}]
```

```
>>> mod.getContinuous() // method-1, list of continuous variable
{'velocity': -1.825929609047952, 'der(velocity)': -9.810000000000005, 'der(height)
↳ ': -1.825929609047952, 'height': 0.65907039052943617}
```

```
>>> mod.getContinuous(["velocity","height"]) // method-2, get specific variable_
↳ value information
(-1.825929609047952, 0.65907039052943617)
```

```
>>> mod.getInputs()
{}
```

```
>>> mod.getOutputs()
{}
```

```
>>> mod.getParameters() // method-1
{'c': 0.9, 'radius': 0.1}
```

```
>>> mod.getParameters(["c","radius"]) // method-2
[0.9, 0.1]
```

```
>>> mod.getSimulationOptions() // method-1
{'stepSize': 0.002, 'stopTime': 1.0, 'tolerance': 1e-06, 'startTime': 0.0, 'solver
↳': 'dassl'}
```

```
>>> mod.getSimulationOptions(["stepSize","tolerance"]) // method-2
[0.002, 1e-06]
```

The `getSolution` method can be used in two different ways.

1. using default result filename
2. use the result filenames provided by user

This provides a way to compare simulation results and perform regression testing

```
>>> mod.getSolutions() // method-1 returns list of simulation variables for which
↳ results are available
['time', 'height', 'velocity', 'der(height)', 'der(velocity)', 'c', 'radius']
```

```
>>> mod.getSolutions(["time","height"]) // return list of numpy arrays
```

```
>>> mod.getSolutions(resultfile="c:/tmpbouncingBall.mat") // method-2 returns list
↳ of simulation variables for which results are available , the resultfile location
↳ is provided by user
```

```
>>> mod.getSolutions(["time","height"],resultfile="c:/tmpbouncingBall.mat") //
↳ return list of array
```

20.2.4 Standard set methods

- `setInputs()`
- `setParameters()`
- `setSimulationOptions()`

Two setting possibilities are accepted using `setXXXs()`, where "XXX" can be any of above functions.

- `setXXX("Name=value")` string of keyword assignments
- `setXXX(["Name1=value1","Name2=value2","Name3=value3"])` list of string of keyword assignments

20.2.5 Usage of setMethods

```
>>> mod.setInput(["cAi=1", "Ti=2"]) // method-2
```

```
>>> mod.setParameters("radius=14") // method-1 setting parameter value
```

```
>>> mod.setParameters(["radius=14", "c=0.5"]) // method-2 setting parameter value,
↳ using second option
```

```
>>> mod.setSimulationOptions(["stopTime=2.0", "tolerance=1e-08"]) // method-2
```

20.2.6 Simulation

An example of how to get parameter names and change the value of parameters using set methods and finally simulate the "BouncingBall.mo" model is given below.

```
>>> mod.getParameters()
{'c': 0.9, 'radius': 0.1}
```

```
>>> mod.setParameters(["radius=14", "c=0.5"]) // setting parameter value
```

To check whether new values are updated to model, we can again query the getParameters().

```
>>> mod.getParameters()
{'c': 0.5, 'radius': 14}
```

The model can be simulated using the *simulate* API in the following ways,

1. without any arguments
2. resultfile (keyword argument) - (only filename is allowed and not the location)
3. simflags (keyword argument) - runtime simulationflags supported by OpenModelica

```
>>> mod.simulate() // method-1 default result file name will be used
>>> mod.simulate(resultfile="tmpbouncingBall.mat") // method-2 resultfile name,
↳ provided by users
>>> mod.simulate(simflags="-noEventEmit -noRestart -override=e=0.3,g=9.71") //
↳ method-3 simulationflags provided by users
```

20.2.7 Linearization

The following methods are proposed for linearization.

- linearize()
- getLinearizationOptions()
- setLinearizationOptions()
- getLinearInputs()
- getLinearOutputs()
- getLinearStates()

20.2.8 Usage of Linearization methods

```
>>> mod.getLinearizationOptions() // method-1
{'simflags': ' ', 'stepSize': 0.002, 'stopTime': 1.0, 'startTime': 0.0,
↪'numberOfIntervals': 500.0, 'tolerance': 1e-08}
```

```
>>> mod.getLinearizationOptions("startTime","stopTime") // method-2
[0.0, 1.0]
```

```
>>> mod.setLinearizationOptions(["stopTime=2.0","tolerance=1e-06"])
```

```
>>> mod.linearize() //returns a tuple of 2D numpy arrays (matrices) A, B, C and D.
```

```
>>> mod.getLinearInputs() //returns a list of strings of names of inputs used_
↪when forming matrices.
```

```
>>> mod.getLinearOutputs() //returns a list of strings of names of outputs used_
↪when forming matrices
```

```
>>> mod.getLinearStates() // returns a list of strings of names of states used_
↪when forming matrices.
```

20.3 PySimulator

PySimulator provides a graphical user interface for performing analyses and simulating different model types (currently Functional Mockup Units and Modelica Models are supported), plotting result variables and applying simulation result analysis tools like Fast Fourier Transform.

Read more about the PySimulator at <https://github.com/PySimulator/PySimulator>.

OMMATLAB – OPENMODELICA MATLAB INTERFACE

OMMatlab – the OpenModelica Matlab API is a free, open source, highly portable Matlab-based interactive session handler for Modelica scripting. It provides the modeler with components for creating a complete Modelica modeling, compilation and simulation environment based on the latest OpenModelica library standard available. OMMatlab is architected to combine both the solving strategy and model building. So domain experts (people writing the models) and computational engineers (people writing the solver code) can work on one unified tool that is industrially viable for optimization of Modelica models, while offering a flexible platform for algorithm development and research. OMMatlab is not a standalone package, it depends upon the OpenModelica installation.

OMMatlab is implemented in Matlab and depends on ZeroMQ - high performance asynchronous messaging library and it supports the Modelica Standard Library version 3.2 that is included in starting with OpenModelica 1.9.2.

To install OMMatlab follow the instructions at <https://github.com/OpenModelica/OMMatlab>

21.1 Features of OMMatlab

The OMMatlab package contains the following features:

- Import the OMMatlab package in Matlab
- Connect with the OpenModelica compiler through zmq sockets
- Able to interact with the OpenModelica compiler through the *available API*
- All the API calls are communicated with the help of the sendExpression method implemented in a Matlab package
- The results are returned as strings

21.2 Test Commands

To get started, create a OMMatlab session object:

```
>>> import OMMatlab.*
>>> omc= OMMatlab()
>>> omc.sendExpression("getVersion() ")
'v1.13.0-dev-531-gde26b558a (64-bit) '
>>> omc.sendExpression("loadModel(Modelica) ")
'true'
>>> omc.sendExpression("model a Real s; equation s=sin(10*time); end a;")
'{a}'
>>> omc.sendExpression("simulate(a) ")
>>> omc.sendExpression("plot(s) ")
'true'
```



21.2.1 Advanced OMMatlab Features

OMMatlab package has advanced functionality for querying more information about the models and simulate them. A list of new user friendly API functionality allows user to extract information about models using matlab objects. A list of API functionality is described below.

To get started, create a ModelicaSystem object:

```
>>> import OMMatlab.*
>>> omc= OMMatlab()
>>> omc.ModelicaSystem("BouncingBall.mo", "BouncingBall")
```

The object constructor requires a minimum of 2 input arguments which are strings, and third input argument which is optional .

- The first input argument must be a string with the file name of the Modelica code, with Modelica file extension ".mo". If the Modelica file is not in the current directory, then the file path must also be included.
- The second input argument must be a string with the name of the Modelica model including the namespace if the model is wrapped within a Modelica package.
- The third input argument (optional) is used to specify the list of dependent libraries or dependent Modelica files The argument can be passed as a string or array of strings e.g.,

```
>>> omc.ModelicaSystem("BouncingBall.mo", "BouncingBall", ["Modelica",
↪ "SystemDynamics", "dcmotor.mo"])
```

- The fourth input argument (optional), which is used to set the command line options e.g.,

```
>>> ModelicaSystem(mod, "BouncingBall.mo", "BouncingBall", ["Modelica",
↪ "SystemDynamics", "dcmotor.mo"], "-d=newInst")
```

Matlab does not support keyword arguments, and hence inorder to skip an argument, empty list should be used "[]" e.g.,

```
>>> ModelicaSystem(mod, "BouncingBall.mo", "BouncingBall", [], "-d=newInst")
```

(continued from previous page)

```
| 'der(h)' | 'false' | 'der(height of ball)' | 'continuous' | 'internal' |
↪'noAlias' | '' | '' |
+-----+-----+-----+-----+-----+-----+-----+-----+-----+-----+-----+
↪-----+-----+-----+-----+-----+-----+-----+-----+-----+-----+-----+
| 'der(v)' | 'false' | 'der(velocity of ball)' | 'continuous' | 'internal' |
↪'noAlias' | '' | '' |
+-----+-----+-----+-----+-----+-----+-----+-----+-----+-----+-----+
↪-----+-----+-----+-----+-----+-----+-----+-----+-----+-----+-----+
```

```
>>> omc.getQuantities("h") // method-2, to query information about single quantity
+-----+-----+-----+-----+-----+-----+-----+-----+-----+-----+-----+
↪-----+-----+-----+-----+-----+-----+-----+-----+-----+-----+-----+
| name      | changeable | description          | variability | causality |
↪alias     | aliasVariable | value |
+-----+-----+-----+-----+-----+-----+-----+-----+-----+-----+-----+
↪-----+-----+-----+-----+-----+-----+-----+-----+-----+-----+-----+
| 'h'       | 'true'     | 'height of ball'    | 'continuous' | 'internal' |
↪'noAlias' | ''         | '1.0' |
+-----+-----+-----+-----+-----+-----+-----+-----+-----+-----+-----+
↪-----+-----+-----+-----+-----+-----+-----+-----+-----+-----+-----+
```

```
>>> omc.getQuantities(["h","v"]) // method-3, to query information about list of
↪quantity
+-----+-----+-----+-----+-----+-----+-----+-----+-----+-----+-----+
↪-----+-----+-----+-----+-----+-----+-----+-----+-----+-----+-----+
| name      | changeable | description          | variability | causality |
↪alias     | aliasVariable | value |
+-----+-----+-----+-----+-----+-----+-----+-----+-----+-----+-----+
↪-----+-----+-----+-----+-----+-----+-----+-----+-----+-----+-----+
| 'h'       | 'true'     | 'height of ball'    | 'continuous' | 'internal' |
↪'noAlias' | ''         | '1.0' |
+-----+-----+-----+-----+-----+-----+-----+-----+-----+-----+-----+
↪-----+-----+-----+-----+-----+-----+-----+-----+-----+-----+-----+
| 'v'       | 'true'     | 'velocity of ball'  | 'continuous' | 'internal' |
↪'noAlias' | ''         | '' |
+-----+-----+-----+-----+-----+-----+-----+-----+-----+-----+-----+
↪-----+-----+-----+-----+-----+-----+-----+-----+-----+-----+-----+
```

```
>>> omc.getContinuous() // method-1, returns struct of continuous variable
struct with fields:
  h      : '1.0'
  v      : ''
  der_h_ : ''
  der_v_ : ''
```

```
>>> omc.getContinuous(["h","v"]) // method-2, returns string array
"1.0" ""
```

```
>>> omc.getInputs()
struct with no fields
```

```
>>> omc.getOutputs()
struct with no fields
```

```
>>> omc.getParameters() // method-1
struct with fields:
  e: '0.7'
  g: '9.810000000000001'
```



```
>>> omc.getParameters(["c","radius"]) // method-2
"0.7" "9.810000000000001"
```

```
>>> omc.getSimulationOptions() // method-1
struct with fields:
  startTime: '0'
  stopTime: '1'
  stepSize: '0.002'
  tolerance: '1e-006'
  solver: 'dassl'
```

```
>>> omc.getSimulationOptions(["stepSize","tolerance"]) // method-2
"0.002", "1e-006"
```

The `getSolution` method can be used in two different ways.

1. using default result filename
2. use the result filenames provided by user

This provides a way to compare simulation results and perform regression testing

```
>>> omc.getSolutions() // method-1 returns string arrays of simulation variables_
↳for which results are available, the default result filename is taken
"time", "height", "velocity", "der(height)", "der(velocity)", "c", "radius"
```

```
>>> omc.getSolutions(["time","h"]) // return list of cell arrays
1x2 cell array
{1x506 double} {1x506 double}
```

```
>>> omc.getSolutions([], "c:/tmpbouncingBall.mat") // method-2 returns string_
↳arrays of simulation variables for which results are available , the resultfile_
↳location is provided by user
"time", "height", "velocity", "der(height)", "der(velocity)", "c", "radius"
```

```
>>> omc.getSolutions(["time","h"], "c:/tmpbouncingBall.mat") // return list of cell_
↳arrays
1x2 cell array
{1x506 double} {1x506 double}
```

21.7 Standard set methods

- `setInputs()`
- `setParameters()`
- `setSimulationOptions()`

Two setting possibilities are accepted using `setXXXs()`, where "XXX" can be any of above functions.

- `setXXX("Name=value")` string of keyword assignments
- `setXXX(["Name1=value1","Name2=value2","Name3=value3"])` array of string of keyword assignments

21.8 Usage of setMethods

```
>>> omc.setInput("cAi=1") // method-1
```

```
>>> omc.setInput(["cAi=1","Ti=2"]) // method-2
```

```
>>> omc.setParameter("e=14") // method-1
```

```
>>> omc.setParameter(["e=14","g=10.8"]) // method-2 setting parameter value using
↳array of string
```

```
>>> omc.setSimulationOptions(["stopTime=2.0","tolerance=1e-08"])
```

21.9 Advanced Simulation

An example of how to do advanced simulation to set parameter values using set methods and finally simulate the "BouncingBall.mo" model is given below .

```
>>> omc.getParameter()
struct with fields:
  e: '0.7'
  g: '9.810000000000001'
```

```
>>> omc.setParameter(["e=0.9","g=9.83"])
```

To check whether new values are updated to model , we can again query the getParameters().

```
>>> omc.getParameter()
struct with fields:
  e: "0.9"
  g: "9.83"
```

Similarly we can also use setInput() to set a value for the inputs during various time interval can also be done using the following.

```
>>> omc.setInput("cAi=1")
```

The model can be simulated using the *simulate* API in the following ways,

1. without any arguments
2. resultfile names provided by user (only filename is allowed and not the location)
3. simflags - runtime simulationflags supported by OpenModelica

```
>>> omc.simulate() // method-1 default result file name will be used
>>> omc.simulate("tmpbouncingBall.mat") // method-2 resultfile name provided by
↳users
>>> omc.simulate([], "-noEventEmit -noRestart -override=e=0.3,g=9.71") // method-3
↳simulationflags provided by users, since matlab does not support keyword
↳argument we skip argument1 result file with empty list
```

21.10 Linearization

The following methods are available for linearization of a modelica model

- linearize()
- getLinearizationOptions()
- setLinearizationOptions()
- getLinearInputs()
- getLinearOutputs()
- getLinearStates()

21.11 Usage of Linearization methods

```
>>> omc.getLinearizationOptions() // method-1
```

```
>>> omc.getLinearizationOptions(["startTime", "stopTime"]) // method-2  
"0.0", "1.0"
```

```
>>> omc.setLinearizationOptions(["stopTime=2.0", "tolerance=1e-08"])
```

```
>>> omc.linearize() //returns a list 2D arrays (matrices) A, B, C and D.
```

```
>>> omc.getLinearInputs() //returns a list of strings of names of inputs used_  
↳when forming matrices.
```

```
>>> omc.getLinearOutputs() //returns a list of strings of names of outputs used_  
↳when forming matrices.
```

```
>>> omc.getLinearStates() // returns a list of strings of names of states used_  
↳when forming matrices.
```

OMJULIA – OPENMODELICA JULIA SCRIPTING

OMJulia – the OpenModelica Julia API is a free, open source, highly portable Julia based interactive session handler for Julia scripting of OpenModelica API functionality. It provides the modeler with components for creating a complete Julia-Modelica modeling, compilation and simulation environment based on the latest OpenModelica implementation and Modelica library standard available. OMJulia is architected to combine both the solving strategy and model building. Thus, domain experts (people writing the models) and computational engineers (people writing the solver code) can work on one unified tool that is industrially viable for optimization of Modelica models, while offering a flexible platform for algorithm development and research. OMJulia is not a standalone package, it depends upon the OpenModelica installation.

OMJulia is implemented in Julia and depends on ZeroMQ - high performance asynchronous messaging library and it supports the Modelica Standard Library version 3.2 that is included in starting with OpenModelica 1.9.2.

To install OMJulia follow the instructions at <https://github.com/OpenModelica/OMJulia.jl>

22.1 Features of OMJulia

The OMJulia package contains the following features:

- Interactive session handling, parsing, interpretation of commands and Modelica expressions for evaluation, simulation, plotting, etc.
- Connect with the OpenModelica compiler through zmq sockets
- Able to interact with the OpenModelica compiler through the *available API*
- Easy access to the Modelica Standard library.
- All the API calls are communicated with the help of the `sendExpression` method implemented in a Julia module
- The results are returned as strings

22.2 Test Commands

To get started, create an OMJulia session object:

```
>>> using OMJulia
>>> omc= OMJulia.OMCSession()
>>> sendExpression(omc, "loadModel(Modelica)")
true
>>> sendExpression(omc, "model a Real s; equation s=sin(10*time); end a;")
1-element Array{Symbol,1}:
 :a
>>> sendExpression(omc, "simulate(a)")
>>> sendExpression(omc, "plot(s)")
true
```



22.2.1 Advanced OMJulia Features

OMJulia package has advanced functionality for querying more information about the models and simulate them. A list of new user friendly API functionality allows user to extract information about models using julia objects. A list of API functionality is described below.

To get started, create a ModelicaSystem object:

```
>>> using OMJulia
>>> mod = OMJulia.OMCSession()
>>> ModelicaSystem(mod, "BouncingBall.mo", "BouncingBall")
```

The object constructor requires a minimum of 2 input arguments which are strings, and third input argument which is optional .

- The first input argument must be a string with the file name of the Modelica code, with Modelica file extension ".mo". If the Modelica file is not in the current directory, then the file path must also be included.
- The second input argument must be a string with the name of the Modelica model including the namespace if the model is wrapped within a Modelica package.
- The third input argument (optional) is used to specify the list of dependent libraries or dependent Modelica files The argument can be passed as a string or array of strings e.g.,

```
>>> ModelicaSystem(mod, "BouncingBall.mo", "BouncingBall", ["Modelica",
↪ "SystemDynamics", "dcmotor.mo"])
```

- The fourth input argument (optional), is a keyword argument which is used to set the command line options e.g.,

```
>>> ModelicaSystem(mod, "BouncingBall.mo", "BouncingBall", ["Modelica",
↪ "SystemDynamics", "dcmotor.mo"], commandLineOptions="-d=newInst")
```

22.3 WorkDirectory

For each OMJulia session a temporary work directory is created and the results are published in that working directory, Inorder to get the workdirectory the users can use the following API

```
>>> getWorkDirectory(mod)
"C:/Users/arupa54/AppData/Local/Temp/jl_5pbew1"
```

22.4 BuildModel

The buildModel API can be used after ModelicaSystem(), in case the model needs to be updated or additional simulationflags needs to be set using sendExpression()

```
>>> buildModel(mod)
```

22.5 Standard get methods

- getQuantities()
- showQuantities()
- getContinuous()
- getInputs()
- getOutputs()
- getParameters()
- getSimulationOptions()
- getSolutions()

Three calling possibilities are accepted using getXXX() where "XXX" can be any of the above functions (eg: getParameters()).

- getXXX() without input argument, returns a dictionary with names as keys and values as values.
- getXXX(S), where S is a string of names.
- getXXX(["S1","S2"]) where S1 and S1 are array of string elements

22.6 Usage of getMethods

```
>>> getQuantities(mod) // method-1, list of all variables from xml file
[{"aliasvariable": None, "Name": "height", "Variability": "continuous", "Value":
↪ "1.0", "alias": "noAlias", "Changeable": "true", "Description": None}, {
↪ "aliasvariable": None, "Name": "c", "Variability": "parameter", "Value": "0.9",
↪ "alias": "noAlias", "Changeable": "true", "Description": None}]
```

```
>>> getQuantities(mod,"height") // method-2, to query information about single_
↪ quantity
[{"aliasvariable": None, "Name": "height", "Variability": "continuous", "Value":
↪ "1.0", "alias": "noAlias", "Changeable": "true", "Description": None}]
```

```
>>> getQuantities(mod,["c","radius"]) // method-3, to query information about list_
↪ of quantity
[{"aliasvariable": None, "Name": "c", "Variability": "parameter", "Value": "0.9",
↪ "alias": "noAlias", "Changeable": "true", "Description": None}, {"aliasvariable
↪ ": None, "Name": "radius", "Variability": "parameter", "Value": "0.1", "alias": "noAlias",
↪ "Changeable": "true", "Description": None}]
```

(continued from previous page)

```
>>> getContinuous(mod) // method-1, list of continuous variable
{"velocity": "-1.825929609047952", "der(velocity)": "-9.8100000000000005",
↪"der(height)": "-1.825929609047952", "height": "0.65907039052943617"}
```

```
>>> getContinuous(mod, ["velocity", "height"]) // method-2, get specific variable_
↪value information
["-1.825929609047952", "0.65907039052943617"]
```

```
>>> getInputs(mod)
{}
```

```
>>> getOutputs(mod)
{}
```

```
>>> getParameters(mod) // method-1
{"c": "0.9", "radius": "0.1"}
```

```
>>> getParameters(mod, ["c", "radius"]) // method-2
["0.9", "0.1"]
```

```
>>> getSimulationOptions(mod) // method-1
{"stepSize": "0.002", "stopTime": "1.0", "tolerance": "1e-06", "startTime": "0.0",
↪"solver": "dassl"}
```

```
>>> getSimulationOptions(mod, ["stepSize", "tolerance"]) // method-2
["0.002", "1e-06"]
```

The `getSolution` method can be used in two different ways.

1. using default result filename
2. use the result filenames provided by user

This provides a way to compare simulation results and perform regression testing

```
>>> getSolutions(mod) // method-1 returns list of simulation variables for which_
↪results are available
["time", "height", "velocity", "der(height)", "der(velocity)", "c", "radius"]
```

```
>>> getSolutions(mod, ["time", "height"]) // return list of array
```

```
>>> getSolutions(mod, resultfile="c:/tmpbouncingBall.mat") // method-2 returns list_
↪of simulation variables for which results are available , the resulfile location_
↪is provided by user
["time", "height", "velocity", "der(height)", "der(velocity)", "c", "radius"]
```

```
>>> getSolutions(mod, ["time", "h"], resultfile="c:/tmpbouncingBall.mat") // return_
↪list of array
```

```
>>> showQuantities(mod) // same as getQuantities() but returns the results in the_
↪form table
```

22.7 Standard set methods

- setInputs()
- setParameters()
- setSimulationOptions()

Two setting possibilities are accepted using setXXXs(), where "XXX" can be any of above functions.

- setXXX("Name=value") string of keyword assignments
- setXXX(["Name1=value1", "Name2=value2", "Name3=value3"]) array of string of keyword assignments

22.8 Usage of setMethods

```
>>> setInputs(mod, "cAi=1") // method-1
```

```
>>> setInputs(mod, ["cAi=1", "Ti=2"]) // method-2
```

```
>>> setParameters(mod, "radius=14") // method-1
```

```
>>> setParameters(mod, ["radius=14", "c=0.5"]) // method-2 setting parameter value_
↳ using array of string
```

```
>>> setSimulationOptions(mod, ["stopTime=2.0", "tolerance=1e-08"])
```

22.9 Advanced Simulation

An example of how to do advanced simulation to set parameter values using set methods and finally simulate the "BouncingBall.mo" model is given below .

```
>>> getParameters(mod)
{"c": "0.9", "radius": "0.1"}
```

```
>>> setParameters(mod, ["radius=14", "c=0.5"])
```

To check whether new values are updated to model , we can again query the getParameters().

```
>>> getParameters(mod)
{"c": "0.5", "radius": "14"}
```

Similarly we can also use setInputs() to set a value for the inputs during various time interval can also be done using the following.

```
>>> setInputs(mod, "cAi=1")
```

The model can be simulated using the *simulate* API in the following ways,

1. without any arguments
2. resultfile (keyword argument) - (only filename is allowed and not the location)
3. simflags (keyword argument) - runtime simulationflags supported by OpenModelica

```
>>> simulate(mod) // method-1 default result file name will be used
>>> simulate(mod, resultfile="tmpbouncingBall.mat") // method-2 resultfile name_
↳ provided by users
>>> simulate(mod, simflags="-noEventEmit -noRestart -override=e=0.3,g=9.71") // _
↳ method-3 simulationflags provided by users
```

(continues on next page)

22.10 Linearization

The following methods are available for linearization of a modelica model

- linearize()
- getLinearizationOptions()
- setLinearizationOptions()
- getLinearInputs()
- getLinearOutputs()
- getLinearStates()

22.11 Usage of Linearization methods

```
>>> getLinearizationOptions(mod) // method-1
{"stepSize": "0.002", "stopTime": "1.0", "startTime": "0.0", "numberOfIntervals":
↳"500.0", "tolerance": "1e-08"}
```

```
>>> getLinearizationOptions(mod, ["startTime", "stopTime"]) // method-2
["0.0", "1.0"]
```

```
>>> setLinearizationOptions(mod, ["stopTime=2.0", "tolerance=1e-06"])
```

```
>>> linearize(mod) //returns a list 2D arrays (matrices) A, B, C and D.
```

```
>>> getLinearInputs(mod) //returns a list of strings of names of inputs used when
↳forming matrices.
```

```
>>> getLinearOutputs(mod) //returns a list of strings of names of outputs used
↳when forming matrices.
```

```
>>> getLinearStates(mod) // returns a list of strings of names of states used when
↳forming matrices.
```

22.12 Sensitivity Analysis

A Method for computing numeric sensitivity of modelica model is available .

- (res1,res2) = sensitivity(arg1,arg2,arg3)

The constructor requires a minimum of 3 input arguments .

- arg1: Array of strings of Modelica Parameter names
- arg2: Array of strings of Modelica Variable names
- arg3: Array of float Excitations of parameters; defaults to scalar 1e-2

The results contains the following .

- res1: Vector of Sensitivity names.
- res2: Array of sensitivities: vector of elements per parameter, each element containing time series per variable.

22.13 Usage

```
>>> (Sn, Sa) = sensitivity(mod, ["UA", "EdR"], ["T", "cA"], [1e-2, 1e-4])
```

With the above list of API calls implemented, the users can have more control over the result types, returned as Julia data structures.

JUPYTER-OPENMODELICA

An OpenModelica Kernel for Jupyter Notebook. All commands are interpreted by OMPython which communicates with OpenModelica Compiler and the results are presented to user.

The project is available at <https://github.com/OpenModelica/jupyter-openmodelica>.

Follow the Readme file to install and start running modelica models directly in Jupyter Notebook

SCRIPTING API

The following are short summaries of OpenModelica scripting commands. These commands are useful for loading and saving classes, reading and storing data, plotting of results, and various other tasks.

The arguments passed to a scripting function should follow syntactic and typing rules for Modelica and for the scripting function in question. In the following tables we briefly indicate the types or character of the formal parameters to the functions by the following notation:

- String typed argument, e.g. "hello", "myfile.mo".
- **TypeName** – class, package or function name, e.g. **MyClass**, **Modelica.Math**.
- VariableName – variable name, e.g. `v1`, `v2`, `vars1[2]` .x, etc.
- Integer or Real typed argument, e.g. 35, 3.14, `xintvariable`.
- options – optional parameters with named formal parameter passing.

24.1 OpenModelica Scripting Commands

The following are brief descriptions of the scripting commands available in the OpenModelica environment. All commands are shown in alphabetical order:

24.1.1 interactiveDumpAbsynToJL

```
function interactiveDumpAbsynToJL
  output String res;
end interactiveDumpAbsynToJL;
```

24.1.2 relocateFunctions

```
function relocateFunctions
  input String fileName;
  input String names[:, 2];
  output Boolean success;
end relocateFunctions;
```

24.1.3 toJulia

```
function toJulia
  output String res;
end toJulia;
```

24.1.4 GC_expand_hp

```
function GC_expand_hp
  input Integer size;
  output Boolean success;
end GC_expand_hp;
```

24.1.5 GC_gcollect_and_unmap

24.1.6 GC_get_prof_stats

```
function GC_get_prof_stats
  output GC_PROFSTATS gcStats;
end GC_get_prof_stats;
```

24.1.7 GC_set_max_heap_size

```
function GC_set_max_heap_size
  input Integer size;
  output Boolean success;
end GC_set_max_heap_size;
```

24.1.8 addClassAnnotation

```
function addClassAnnotation
  input TypeName class_;
  input ExpressionOrModification annotate;
  output Boolean bool;
end addClassAnnotation;
```

24.1.9 addInitialState

```
function addInitialState
  input TypeName cl;
  input String state;
  input ExpressionOrModification annotate;
  output Boolean bool;
end addInitialState;
```

24.1.10 addTransition

```
function addTransition
  input TypeName cl;
  input String from;
  input String to;
  input String condition;
  input Boolean immediate = true;
  input Boolean reset = true;
  input Boolean synchronize = false;
  input Integer priority = 1;
  input ExpressionOrModification annotate;
  output Boolean bool;
end addTransition;
```

24.1.11 alarm

```
impure function alarm
  input Integer seconds;
  output Integer previousSeconds;
end alarm;
```

24.1.12 appendEnvironmentVar

Appends a variable to the environment variables list.

```
function appendEnvironmentVar
  input String var;
  input String value;
  output String result "returns \"error\" if the variable could not be appended";
end appendEnvironmentVar;
```

24.1.13 basename

```
function basename
  input String path;
  output String basename;
end basename;
```

24.1.14 buildEncryptedPackage

```
function buildEncryptedPackage
  input TypeName className "the class that should encrypted";
  input Boolean encrypt = true;
  output Boolean success;
end buildEncryptedPackage;
```

24.1.15 buildLabel

builds Label.

```
function buildLabel
  input TypeName className "the class that should be built";
  input Real startTime = 0.0 "the start time of the simulation. <default> = 0.0";
  input Real stopTime = 1.0 "the stop time of the simulation. <default> = 1.0";
  input Integer numberOfIntervals = 500 "number of intervals in the result file.
↳<default> = 500";
  input Real tolerance = 1e-6 "tolerance used by the integration method. <default>↳
↳= 1e-6";
  input String method = "dassl" "integration method used for simulation. <default>↳
↳= dassl";
  input String fileNamePrefix = "" "fileNamePrefix. <default> = \"\"";
  input String options = "" "options. <default> = \"\"";
  input String outputFormat = "mat" "Format for the result file. <default> = \"mat\
↳\"";
  input String variableFilter = ".*" "Filter for variables that should store in↳
↳result file. <default> = \".*\\"";
  input String cflags = "" "cflags. <default> = \"\"";
  input String simflags = "" "simflags. <default> = \"\"";
  output String[2] buildModelResults;
end buildLabel;
```

24.1.16 buildModel

builds a modelica model by generating c code and build it.

It does not run the code!

The only required argument is the className, while all others have some default↳
↳values.

```
simulate(className, [startTime], [stopTime], [numberOfIntervals], [tolerance],↳
↳[method], [fileNamePrefix], [options], [outputFormat], [variableFilter],↳
↳[cflags], [simflags])
```

Example command:

```
simulate(A);
```

```
function buildModel
  input TypeName className "the class that should be built";
  input Real startTime = "<default>" "the start time of the simulation. <default>↳
↳= 0.0";
  input Real stopTime = 1.0 "the stop time of the simulation. <default> = 1.0";
  input Real numberOfIntervals = 500 "number of intervals in the result file.
↳<default> = 500";
  input Real tolerance = 1e-6 "tolerance used by the integration method. <default>↳
↳= 1e-6";
  input String method = "<default>" "integration method used for simulation.
↳<default> = dassl";
  input String fileNamePrefix = "<default>" "fileNamePrefix. <default> = \"\"";
  input String options = "<default>" "options. <default> = \"\"";
  input String outputFormat = "mat" "Format for the result file. <default> = \"mat\
↳\"";
  input String variableFilter = ".*" "Filter for variables that should store in↳
↳result file. <default> = \".*\\"";
  input String cflags = "<default>" "cflags. <default> = \"\"";
  input String simflags = "<default>" "simflags. <default> = \"\"";
  output String[2] buildModelResults;
end buildModel;
```

24.1.17 buildModelFMU

translates a modelica **model** into a Functional Mockup Unit. The only required argument is the **className**, **while** all others have some default values.

Example command:

```
buildModelFMU(className, version="2.0");
```

```
function buildModelFMU
  input TypeName className "the class that should translated";
  input String version = "2.0" "FMU version, 1.0 or 2.0.";
  input String fmuType = "me" "FMU type, me (model exchange), cs (co-simulation),
  ↪me_cs (both model exchange and co-simulation)";
  input String fileNamePrefix = "<default>" "fileNamePrefix. <default> = \
  ↪\"className\"";
  input String platforms[:] = {"static"} "The list of platforms to generate code
  ↪for. \"dynamic\"=current platform, dynamically link the runtime. \"static\"
  ↪=current platform, statically link everything. Else, use a host triple, e.g. \
  ↪\"x86_64-linux-gnu\" or \"x86_64-w64-mingw32\"";
  input Boolean includeResources = false "include Modelica based resources via
  ↪loadResource or not";
  output String generatedFileName "Returns the full path of the generated FMU.";
end buildModelFMU;
```

24.1.18 buildOpenTURNInterface

generates wrapper code **for** OpenURNS

```
function buildOpenTURNInterface
  input TypeName className;
  input String pythonTemplateFile;
  input Boolean showFlatModelica = false;
  output String outPythonScript;
end buildOpenTURNInterface;
```

24.1.19 cd

change directory to the given path (which may be either relative **or** absolute)
returns the new working directory on success **or** a message on failure
if the given path is the empty string, the **function simply** returns the current working directory.

```
function cd
  input String newWorkingDirectory = "";
  output String workingDirectory;
end cd;
```

24.1.20 checkAllModelsRecursive

Checks all models recursively **and** returns number of variables **and** equations.

```
function checkAllModelsRecursive
  input TypeName className;
  input Boolean checkProtected = false "Checks also protected classes if true";
  output String result;
end checkAllModelsRecursive;
```

24.1.21 checkCodeGraph

Checks **if** the given taskgraph has the same structure as the graph described **in** the `codefile`.

```
function checkCodeGraph
  input String graphfile;
  input String codefile;
  output String[:] result;
end checkCodeGraph;
```

24.1.22 checkInterfaceOfPackages

```
function checkInterfaceOfPackages
  input TypeName cl;
  input String dependencyMatrix[:, :];
  output Boolean success;
end checkInterfaceOfPackages;
```

24.1.23 checkModel

Checks a **model** **and** returns number of variables **and** equations.

```
function checkModel
  input TypeName className;
  output String result;
end checkModel;
```

24.1.24 checkSettings

Display some diagnostics.

```
function checkSettings
  output CheckSettingsResult result;
end checkSettings;
```

24.1.25 checkTaskGraph

Checks **if** the given taskgraph has the same structure as the reference taskgraph_ ↪**and if** all attributes are set correctly.

```
function checkTaskGraph
  input String filename;
  input String reffilename;
  output String[:] result;
end checkTaskGraph;
```

24.1.26 classAnnotationExists

Check **if annotation** exists

```
function classAnnotationExists
  input TypeName className;
  input TypeName annotationName;
  output Boolean exists;
end classAnnotationExists;
```

24.1.27 clear

Clears everything: symboltable **and** variables.

```
function clear
  output Boolean success;
end clear;
```

24.1.28 clearCommandLineOptions

Resets all command-line flags to their default values.

```
function clearCommandLineOptions
  output Boolean success;
end clearCommandLineOptions;
```

24.1.29 clearDebugFlags

Resets all debug flags to their default values.

```
function clearDebugFlags
  output Boolean success;
end clearDebugFlags;
```

24.1.30 clearMessages

Clears the error buffer.

```
function clearMessages
  output Boolean success;
end clearMessages;
```

24.1.31 clearProgram

Clears loaded .

```
function clearProgram
  output Boolean success;
end clearProgram;
```

24.1.32 clearVariables

Clear all user defined variables.

```
function clearVariables
  output Boolean success;
end clearVariables;
```

24.1.33 closeSimulationResultFile

Closes the current simulation result file.
Only needed by Windows. Windows cannot handle reading **and** writing to the same file,
↳from different processes.
To allow OMEdit to make successful simulation again on the same file we must close,
↳the file after reading the Simulation Result Variables.
Even OMEdit only use this API **for** Windows.

```
function closeSimulationResultFile
  output Boolean success;
end closeSimulationResultFile;
```

24.1.34 codeToString

```
function codeToString
  input $Code className;
  output String string;
end codeToString;
```

24.1.35 compareFiles

```
impure function compareFiles
  input String file1;
  input String file2;
  output Boolean isEqual;
end compareFiles;
```

24.1.36 compareFilesAndMove

```
impure function compareFilesAndMove
  input String newFile;
  input String oldFile;
  output Boolean success;
end compareFilesAndMove;
```

24.1.37 compareSimulationResults

compares simulation results.

```
function compareSimulationResults
  input String filename;
  input String reffilename;
  input String logfile;
  input Real relTol = 0.01;
  input Real absTol = 0.0001;
  input String[:] vars = fill("", 0);
  output String[:] result;
end compareSimulationResults;
```

24.1.38 convertUnits

```
function convertUnits
  input String s1;
  input String s2;
  output Boolean unitsCompatible;
  output Real scaleFactor;
  output Real offset;
end convertUnits;
```

24.1.39 copy

copies the source file to the destination file. Returns **true** if the file has been copied.

```
function copy
  input String source;
  input String destination;
  output Boolean success;
end copy;
```

24.1.40 copyClass

Copies a **class** **within** the same level

```
function copyClass
  input TypeName className "the class that should be copied";
  input String newClassName "the name for new class";
  input TypeName withIn = $Code(TopLevel) "the with in path for new class";
  output Boolean result;
end copyClass;
```

24.1.41 countMessages

```
function countMessages
  output Integer numMessages;
  output Integer numErrors;
  output Integer numWarnings;
end countMessages;
```

24.1.42 deleteFile

Deletes a file with the given name.

```
function deleteFile
  input String fileName;
  output Boolean success;
end deleteFile;
```

24.1.43 deleteInitialState

```
function deleteInitialState
  input TypeName cl;
  input String state;
  output Boolean bool;
end deleteInitialState;
```

24.1.44 deleteTransition

```
function deleteTransition
  input TypeName cl;
  input String from;
  input String to;
  input String condition;
  input Boolean immediate;
  input Boolean reset;
  input Boolean synchronize;
  input Integer priority;
  output Boolean bool;
end deleteTransition;
```

24.1.45 deltaSimulationResults

calculates the sum of absolute errors.

```
function deltaSimulationResults
  input String filename;
  input String reffilename;
  input String method "method to compute then error. choose lnorm, 2norm, maxerr";
  input String[:] vars = fill("", 0);
  output Real result;
end deltaSimulationResults;
```

24.1.46 diffModelicaFileListings

Creates diffs of two strings corresponding to Modelica files

```
function diffModelicaFileListings
  input String before, after;
  input DiffFormat diffFormat = DiffFormat.color;
  output String result;
end diffModelicaFileListings;
```

24.1.47 diffSimulationResults

compares simulation results.

```
function diffSimulationResults
  input String actualFile;
  input String expectedFile;
  input String diffPrefix;
  input Real relTol = 1e-3 "y tolerance";
  input Real relTolDiffMinMax = 1e-4 "y tolerance based on the difference between_
↳the maximum and minimum of the signal";
  input Real rangeDelta = 0.002 "x tolerance";
  input String[:] vars = fill("", 0);
  input Boolean keepEqualResults = false;
  output Boolean success;
  output String[:] failVars;
end diffSimulationResults;
```

24.1.48 diffSimulationResultsHtml

```
function diffSimulationResultsHtml
  input String var;
  input String actualFile;
  input String expectedFile;
  input Real relTol = 1e-3 "y tolerance";
  input Real relTolDiffMinMax = 1e-4 "y tolerance based on the difference between_
↳the maximum and minimum of the signal";
  input Real rangeDelta = 0.002 "x tolerance";
  output String html;
end diffSimulationResultsHtml;
```

24.1.49 directoryExists

```
function directoryExists
  input String dirName;
  output Boolean exists;
end directoryExists;
```

24.1.50 dirname

```
function dirname
  input String path;
  output String dirname;
end dirname;
```

24.1.51 disableNewInstantiation

```
function disableNewInstantiation
  output Boolean success;
end disableNewInstantiation;
```

24.1.52 dumpXMLDAE

Outputs the DAE system corresponding to a specific `model`.

```
function dumpXMLDAE
  input TypeName className;
  input String translationLevel = "flat" "flat, optimiser, backEnd, or stateSpace";
  input Boolean addOriginalAdjacencyMatrix = false;
  input Boolean addSolvingInfo = false;
  input Boolean addMathMLCode = false;
  input Boolean dumpResiduals = false;
  input String fileNamePrefix = "<default>" "this is the className in string form,
↳by default";
  input String rewriteRulesFile = "" "the file from where the rewriteRules are read,
↳ default is empty which means no rewrite rules";
  output Boolean success "if the function succeeded true/false";
  output String xmlfileName "the Xml file";
end dumpXMLDAE;
```

24.1.53 echo

echo(`false`) disables Interactive `output`, echo(`true`) enables it again.

```
function echo
  input Boolean setEcho;
  output Boolean newEcho;
end echo;
```

24.1.54 enableNewInstantiation

```
function enableNewInstantiation
  output Boolean success;
end enableNewInstantiation;
```

24.1.55 escapeXML

```
function escapeXML
  input String inStr;
  output String outStr;
end escapeXML;
```

24.1.56 exit

```
function exit
  input Integer status;
end exit;
```

24.1.57 exportToFigaro

```
function exportToFigaro
  input TypeName path;
  input String directory = cd();
  input String database;
  input String mode;
  input String options;
  input String processor;
  output Boolean success;
end exportToFigaro;
```

24.1.58 extendsFrom

returns **true** if the given **class extends** from the given base **class**

```
function extendsFrom
  input TypeName className;
  input TypeName baseClassName;
  output Boolean res;
end extendsFrom;
```

24.1.59 filterSimulationResults

```
function filterSimulationResults
  input String inFile;
  input String outFile;
  input String[:] vars;
  input Integer numberOfIntervals = 0 "0=Do not resample";
  input Boolean removeDescription = false;
  output Boolean success;
end filterSimulationResults;
```

24.1.60 generateCode

The **input** is a **function name for** which C-code is generated **and** compiled into a dll/
↪so

```
function generateCode
  input TypeName className;
  output Boolean success;
end generateCode;
```

24.1.61 generateEntryPoint

```
function generateEntryPoint
  input String fileName;
  input TypeName entryPoint;
  input String url = "https://trac.openmodelica.org/OpenModelica/newticket";
end generateEntryPoint;
```

24.1.62 generateHeader

```
function generateHeader
  input String fileName;
  output Boolean success;
end generateHeader;
```

24.1.63 generateJuliaHeader

```
function generateJuliaHeader
  input String fileName;
  output Boolean success;
end generateJuliaHeader;
```

24.1.64 generateScriptingAPI

```
function generateScriptingAPI
  input TypeName cl;
  input String name;
  output Boolean success;
  output String moFile;
  output String qtFile;
  output String qtHeader;
end generateScriptingAPI;
```

24.1.65 generateSeparateCode

```
function generateSeparateCode
  input TypeName className;
  input Boolean cleanCache = false "If true, the cache is reset between each_
↳generated package. This conserves memory at the cost of speed.";
  output Boolean success;
end generateSeparateCode;
```

24.1.66 generateSeparateCodeDependencies

```
function generateSeparateCodeDependencies
  input String stampSuffix = ".c" "Suffix to add to dependencies (often .c.stamp)";
  output String[:] dependencies;
end generateSeparateCodeDependencies;
```

24.1.67 generateSeparateCodeDependenciesMakefile

```
function generateSeparateCodeDependenciesMakefile
  input String filename "The file to write the makefile to";
  input String directory = "" "The relative path of the generated files";
  input String suffix = ".c" "Often .stamp since we do not update all the files";
  output Boolean success;
end generateSeparateCodeDependenciesMakefile;
```

24.1.68 generateVerificationScenarios

```
function generateVerificationScenarios
  input TypeName path;
  output Boolean success;
end generateVerificationScenarios;
```

24.1.69 getAlgorithmCount

Counts the number of Algorithm sections **in** a **class**.

```
function getAlgorithmCount
  input TypeName class_;
  output Integer count;
end getAlgorithmCount;
```

24.1.70 getAlgorithmItemsCount

Counts the number of Algorithm items **in** a **class**.

```
function getAlgorithmItemsCount
  input TypeName class_;
  output Integer count;
end getAlgorithmItemsCount;
```

24.1.71 getAllSubtypeOf

Returns the list of all classes that extend from className given a parentClass_
 ↳where the lookup **for** className should start

```
function getAllSubtypeOf
  input TypeName className;
  input TypeName parentClass = $Code(AllLoadedClasses);
  input Boolean qualified = false;
  input Boolean includePartial = false;
  input Boolean sort = false;
  output TypeName classNames[:];
end getAllSubtypeOf;
```

24.1.72 getAnnotationCount

Counts the number of Annotation sections **in** a **class**.

```
function getAnnotationCount
  input TypeName class_;
  output Integer count;
end getAnnotationCount;
```

24.1.73 getAnnotationModifierValue

```
function getAnnotationModifierValue
  input TypeName name;
  input String vendorannotation;
  input String modifiername;
  output String modifiernamevalue;
end getAnnotationModifierValue;
```

24.1.74 getAnnotationNamedModifiers

```
function getAnnotationNamedModifiers
  input TypeName name;
  input String vendorannotation;
  output String[:] modifiernamelist;
end getAnnotationNamedModifiers;
```

24.1.75 getAnnotationVersion

Returns the current **annotation** version.

```
function getAnnotationVersion
  output String annotationVersion;
end getAnnotationVersion;
```

24.1.76 getAstAsCorbaString

Print the whole AST on the CORBA format **for** records, e.g.

```
record Absyn.PROGRAM
classes = ...,
within_ = ...,
globalBuildTimes = ...
end Absyn.PROGRAM;
```

```
function getAstAsCorbaString
  input String fileName = "<interactive>";
  output String result "returns the string if fileName is interactive; else it_
↳returns ok or error depending on if writing the file succeeded";
end getAstAsCorbaString;
```

24.1.77 getAvailableIndexReductionMethods

```
function getAvailableIndexReductionMethods
  output String[:] allChoices;
  output String[:] allComments;
end getAvailableIndexReductionMethods;
```

24.1.78 getAvailableLibraries

```
function getAvailableLibraries
  output String[:] libraries;
end getAvailableLibraries;
```

24.1.79 getAvailableMatchingAlgorithms

```
function getAvailableMatchingAlgorithms
  output String[:] allChoices;
  output String[:] allComments;
end getAvailableMatchingAlgorithms;
```

24.1.80 getAvailableTearingMethods

```
function getAvailableTearingMethods
  output String[:] allChoices;
  output String[:] allComments;
end getAvailableTearingMethods;
```

24.1.81 getBooleanClassAnnotation

Check **if** **annotation** exists **and** returns its value

```
function getBooleanClassAnnotation
  input TypeName className;
  input TypeName annotationName;
  output Boolean value;
end getBooleanClassAnnotation;
```

24.1.82 getBuiltinType

```
function getBuiltinType
  input TypeName cl;
  output String name;
end getBuiltinType;
```

24.1.83 getCFlags

```
CFLAGS
```

```
function getCFlags
  output String outString;
end getCFlags;
```

24.1.84 getCXXCompiler

```
CXX
```

```
function getCXXCompiler
  output String compiler;
end getCXXCompiler;
```

24.1.85 getClassComment

```
Returns the class comment.
```

```
function getClassComment
  input TypeName cl;
  output String comment;
end getClassComment;
```

24.1.86 getClassInformation

```
function getClassInformation
  input TypeName cl;
  output String restriction, comment;
  output Boolean partialPrefix, finalPrefix, encapsulatedPrefix;
  output String fileName;
  output Boolean fileReadOnly;
  output Integer lineNumberStart, columnNumberStart, lineNumberEnd, ↵
↵columnNumberEnd;
  output String dimensions[:];
  output Boolean isProtectedClass;
  output Boolean isDocumentationClass;
  output String version;
  output String preferredView;
  output Boolean state;
  output String access;
end getClassInformation;
```

24.1.87 getClassNames

Returns the list of **class names** defined **in** the **class**.

```
function getClassNames
  input TypeName class_ = $Code(AllLoadedClasses);
  input Boolean recursive = false;
  input Boolean qualified = false;
  input Boolean sort = false;
  input Boolean builtin = false "List also builtin classes if true";
  input Boolean showProtected = false "List also protected classes if true";
  input Boolean includeConstants = false "List also constants in the class if true
↪";
  output TypeName classNames[:];
end getClassNames;
```

24.1.88 getClassRestriction

```
function getClassRestriction
  input TypeName cl;
  output String restriction;
end getClassRestriction;
```

24.1.89 getClassesInModelicaPath

MathCore-specific or not? Who knows!

```
function getClassesInModelicaPath
  output String classesInModelicaPath;
end getClassesInModelicaPath;
```

24.1.90 getCommandLineOptions

Returns all command line options who have non-default values as a list of strings. The format of the strings is '--flag=value --flag2=value2'.

```
function getCommandLineOptions
  output String[:] flags;
end getCommandLineOptions;
```

24.1.91 getCompileCommand

```
function getCompileCommand
  output String compileCommand;
end getCompileCommand;
```

24.1.92 getCompiler

```
CC
```

```
function getCompiler
  output String compiler;
end getCompiler;
```

24.1.93 GetComponentModifierNames

```
function GetComponentModifierNames
  input TypeName class_;
  input String componentName;
  output String[:] modifiers;
end GetComponentModifierNames;
```

24.1.94 GetComponentModifierValue

```
function GetComponentModifierValue
  input TypeName class_;
  input TypeName modifier;
  output String value;
end GetComponentModifierValue;
```

24.1.95 GetComponentModifierValues

```
function GetComponentModifierValues
  input TypeName class_;
  input TypeName modifier;
  output String value;
end GetComponentModifierValues;
```

24.1.96 getComponentsTest

```
function getComponentsTest
  input TypeName name;
  output Component[:] components;
  record Component
    String className;
    // when building record the constructor. Records are allowed to contain only
    ↪ components of basic types, arrays of basic types or other records.
    String name;
    String comment;
    Boolean isProtected;
    Boolean isFinal;
    Boolean isFlow;
    Boolean isStream;
    Boolean isReplaceable;
    String variability "'constant', 'parameter', 'discrete', ''";
    String innerOuter "'inner', 'outer', ''";
    String inputOutput "'input', 'output', ''";
    String dimensions[:];
  end Component;
end getComponentsTest;
```

24.1.97 getConfigFlagValidOptions

Returns the list of valid options **for** a string config flag, **and** the description, **↪** strings **for** these options **if** available

```
function getConfigFlagValidOptions
  input String flag;
  output String validOptions[:];
  output String mainDescription;
  output String descriptions[:];
end getConfigFlagValidOptions;
```

24.1.98 getConnectionCount

Counts the number of **connect** equation in a **class**.

```
function getConnectionCount
  input TypeName className;
  output Integer count;
end getConnectionCount;
```

24.1.99 getConversionsFromVersions

```
function getConversionsFromVersions
  input TypeName pack;
  output String[:] withoutConversion;
  output String[:] withConversion;
end getConversionsFromVersions;
```

24.1.100 getDefaultOpenCLDevice

Returns the id **for** the default OpenCL device to be used.

```
function getDefaultOpenCLDevice
  output Integer defdevid;
end getDefaultOpenCLDevice;
```

24.1.101 getDerivedClassModifierNames

Returns the derived **class** **modifier** names.

Example command:

```
type Resistance = Real(final quantity="Resistance", final unit="Ohm");
getDerivedClassModifierNames(Resistance) => {"quantity", "unit"}
```

```
function getDerivedClassModifierNames
  input TypeName className;
  output String[:] modifierNames;
end getDerivedClassModifierNames;
```

24.1.102 getDerivedClassModifierValue

Returns the derived **class modifier** value.

Example command:

```
type Resistance = Real(final quantity="Resistance", final unit="Ohm");
getDerivedClassModifierValue(Resistance, unit); => " = "Ohm"
getDerivedClassModifierValue(Resistance, quantity); => " = "Resistance"
```

```
function getDerivedClassModifierValue
  input TypeName className;
  input TypeName modifierName;
  output String modifierValue;
end getDerivedClassModifierValue;
```

24.1.103 getDerivedUnits

```
function getDerivedUnits
  input String baseUnit;
  output String[:] derivedUnits;
end getDerivedUnits;
```

24.1.104 getDocumentationAnnotation

Returns the documentaiton **annotation** defined **in** the **class**.

```
function getDocumentationAnnotation
  input TypeName cl;
  output String out[3] "{info,revision,infoHeader} TODO: Should be changed to have_
↳2 outputs instead of an array of 2 Strings...";
end getDocumentationAnnotation;
```

24.1.105 getElementModifierNames

```
function getElementModifierNames
  input TypeName className;
  input String elementName;
  output String[:] modifiers;
end getElementModifierNames;
```

24.1.106 getElementModifierValue

```
function getElementModifierValue
  input TypeName className;
  input TypeName modifier;
  output String value;
end getElementModifierValue;
```

24.1.107 getElementModifierValues

```
function getElementModifierValues
  input TypeName className;
  input TypeName modifier;
  output String value;
end getElementModifierValues;
```

24.1.108 getEnvironmentVar

Returns the value of the environment variable.

```
function getEnvironmentVar
  input String var;
  output String value "returns empty string on failure";
end getEnvironmentVar;
```

24.1.109 getEquationCount

Counts the number of Equation sections **in** a **class**.

```
function getEquationCount
  input TypeName class_;
  output Integer count;
end getEquationCount;
```

24.1.110 getEquationItemsCount

Counts the number of Equation items **in** a **class**.

```
function getEquationItemsCount
  input TypeName class_;
  output Integer count;
end getEquationItemsCount;
```

24.1.111 getErrorString

Returns the current error message. [file.mo:n:n-n:n:b] Error: message

```
impure function getErrorString
  input Boolean warningsAsErrors = false;
  output String errorString;
end getErrorString;
```

24.1.112 getImportCount

Counts the number of Import sections **in** a **class**.

```
function getImportCount
  input TypeName class_;
  output Integer count;
end getImportCount;
```

24.1.113 getIndexReductionMethod

```
function getIndexReductionMethod
  output String selected;
end getIndexReductionMethod;
```

24.1.114 getInheritedClasses

```
function getInheritedClasses
  input TypeName name;
  output TypeName inheritedClasses[:];
end getInheritedClasses;
```

24.1.115 getInitialAlgorithmCount

Counts the number of Initial Algorithm sections **in** a **class**.

```
function getInitialAlgorithmCount
  input TypeName class_;
  output Integer count;
end getInitialAlgorithmCount;
```

24.1.116 getInitialAlgorithmItemsCount

Counts the number of Initial Algorithm items **in** a **class**.

```
function getInitialAlgorithmItemsCount
  input TypeName class_;
  output Integer count;
end getInitialAlgorithmItemsCount;
```

24.1.117 getInitialEquationCount

Counts the number of Initial Equation sections **in** a **class**.

```
function getInitialEquationCount
  input TypeName class_;
  output Integer count;
end getInitialEquationCount;
```

24.1.118 getInitialEquationItemsCount

Counts the number of Initial Equation items **in** a **class**.

```
function getInitialEquationItemsCount
  input TypeName class_;
  output Integer count;
end getInitialEquationItemsCount;
```

24.1.119 getInitialStates

```
function getInitialStates
  input TypeName cl;
  output String[:, :] initialStates;
end getInitialStates;
```

24.1.120 getInstallationDirectoryPath

This returns OPENMODELICAHOME **if** it is set; on some platforms the default path is `~`
→ returned **if** it is **not** set.

```
function getInstallationDirectoryPath
  output String installationDirectoryPath;
end getInstallationDirectoryPath;
```

24.1.121 getInstantiatedParametersAndValues

```
function getInstantiatedParametersAndValues
  input TypeName cls;
  output String[:] values;
end getInstantiatedParametersAndValues;
```

24.1.122 getLanguageStandard

Returns the current Modelica Language Standard **in** use.

```
function getLanguageStandard
  output String outVersion;
end getLanguageStandard;
```

24.1.123 getLinker

```
function getLinker
  output String linker;
end getLinker;
```

24.1.124 getLinkerFlags

```
function getLinkerFlags
  output String linkerFlags;
end getLinkerFlags;
```

24.1.125 getLoadedLibraries

```
function getLoadedLibraries
  output String[:, 2] libraries;
end getLoadedLibraries;
```

24.1.126 getMatchingAlgorithm

```
function getMatchingAlgorithm
  output String selected;
end getMatchingAlgorithm;
```

24.1.127 getMemorySize

```
function getMemorySize
  output Real memory(unit = "MiB");
end getMemorySize;
```

24.1.128 getMessagesString

```
see getErrorString()
```

```
function getMessagesString
  output String messagesString;
end getMessagesString;
```

24.1.129 getModelicaPath

```
Get the Modelica Library Path.
```

```
function getModelicaPath
  output String modelicaPath;
end getModelicaPath;
```

24.1.130 getNoSimplify

Returns `true` if noSimplify flag is set.

```

function getNoSimplify
  output Boolean noSimplify;
end getNoSimplify;

```

24.1.131 getNthAlgorithm

Returns the Nth Algorithm section.

```

function getNthAlgorithm
  input TypeName class_;
  input Integer index;
  output String result;
end getNthAlgorithm;

```

24.1.132 getNthAlgorithmItem

Returns the Nth Algorithm Item.

```

function getNthAlgorithmItem
  input TypeName class_;
  input Integer index;
  output String result;
end getNthAlgorithmItem;

```

24.1.133 getNthAnnotationString

Returns the Nth Annotation section as string.

```

function getNthAnnotationString
  input TypeName class_;
  input Integer index;
  output String result;
end getNthAnnotationString;

```

24.1.134 getNthConnection

Returns the Nth connection.

Example command:

```
getNthConnection(A) => {"from", "to", "comment"}
```

```

function getNthConnection
  input TypeName className;
  input Integer index;
  output String[:] result;
end getNthConnection;

```

24.1.135 getNthEquation

Returns the Nth Equation section.

```
function getNthEquation
  input TypeName class_;
  input Integer index;
  output String result;
end getNthEquation;
```

24.1.136 getNthEquationItem

Returns the Nth Equation Item.

```
function getNthEquationItem
  input TypeName class_;
  input Integer index;
  output String result;
end getNthEquationItem;
```

24.1.137 getNthImport

Returns the Nth Import as string.

```
function getNthImport
  input TypeName class_;
  input Integer index;
  output String out[3] {"Path\","Id\","Kind\"};
end getNthImport;
```

24.1.138 getNthInitialAlgorithm

Returns the Nth Initial Algorithm section.

```
function getNthInitialAlgorithm
  input TypeName class_;
  input Integer index;
  output String result;
end getNthInitialAlgorithm;
```

24.1.139 getNthInitialAlgorithmItem

Returns the Nth Initial Algorithm Item.

```
function getNthInitialAlgorithmItem
  input TypeName class_;
  input Integer index;
  output String result;
end getNthInitialAlgorithmItem;
```

24.1.140 getNthInitialEquation

Returns the Nth Initial Equation section.

```

function getNthInitialEquation
  input TypeName class_;
  input Integer index;
  output String result;
end getNthInitialEquation;

```

24.1.141 getNthInitialEquationItem

Returns the Nth Initial Equation Item.

```

function getNthInitialEquationItem
  input TypeName class_;
  input Integer index;
  output String result;
end getNthInitialEquationItem;

```

24.1.142 getOrderConnections

Returns `true if` orderConnections flag is set.

```

function getOrderConnections
  output Boolean orderConnections;
end getOrderConnections;

```

24.1.143 getPackages

Returns the list of packages defined `in` the `class`.

```

function getPackages
  input TypeName class_ = $Code(AllLoadedClasses);
  output TypeName classNames[:];
end getPackages;

```

24.1.144 getParameterNames

```

function getParameterNames
  input TypeName class_;
  output String[:] parameters;
end getParameterNames;

```

24.1.145 getParameterValue

```
function getParameterValue
  input TypeName class_;
  input String parameterName;
  output String parameterValue;
end getParameterValue;
```

24.1.146 getSettings

```
function getSettings
  output String settings;
end getSettings;
```

24.1.147 getShowAnnotations

```
function getShowAnnotations
  output Boolean show;
end getShowAnnotations;
```

24.1.148 getSimulationOptions

```
function getSimulationOptions
  input TypeName name;
  input Real defaultStartTime = 0.0;
  input Real defaultStopTime = 1.0;
  input Real defaultTolerance = 1e-6;
  input Integer defaultNumberOfIntervals = 500 "May be overridden by defining_
↳defaultInterval instead";
  input Real defaultInterval = 0.0 "If = 0.0, then numberOfIntervals is used to_
↳calculate the step size";
  output Real startTime;
  output Real stopTime;
  output Real tolerance;
  output Integer numberOfIntervals;
  output Real interval;
end getSimulationOptions;
```

24.1.149 getSourceFile

Returns the filename of the **class**.

```
function getSourceFile
  input TypeName class_;
  output String filename "empty on failure";
end getSourceFile;
```

24.1.150 getTearingMethod

```
function getTearingMethod
  output String selected;
end getTearingMethod;
```

24.1.151 getTempDirectoryPath

Returns the current user temporary directory location.

```
function getTempDirectoryPath
  output String tempDirectoryPath;
end getTempDirectoryPath;
```

24.1.152 getTimeStamp

```
function getTimeStamp
  input TypeName cl;
  output Real timeStamp;
  output String timeStampAsString;
end getTimeStamp;
```

24.1.153 getTransitions

```
function getTransitions
  input TypeName cl;
  output String[:, :] transitions;
end getTransitions;
```

24.1.154 getUsedClassNames

Returns the list of **class names** used **in** the total program defined by the **class**.

```
function getUsedClassNames
  input TypeName className;
  output TypeName classNames[:];
end getUsedClassNames;
```

24.1.155 getUses

```
function getUses
  input TypeName pack;
  output String[:, :] uses;
end getUses;
```

24.1.156 getVectorizationLimit

```
function getVectorizationLimit
  output Integer vectorizationLimit;
end getVectorizationLimit;
```

24.1.157 getVersion

Returns the version of the Modelica compiler.

```
function getVersion
  input TypeName cl = $Code(OpenModelica);
  output String version;
end getVersion;
```

24.1.158 help

display the OpenModelica help text.

```
function help
  input String topic = "topics";
  output String helpText;
end help;
```

24.1.159 iconv

The iconv() **function converts** one multibyte characters from one character set to another.
See man (3) iconv **for** more information.

```
function iconv
  input String string;
  input String from;
  input String to = "UTF-8";
  output String result;
end iconv;
```

24.1.160 importFMU

Imports the Functional Mockup Unit
Example command:
importFMU("A.fmu");

```
function importFMU
  input String filename "the fmu file name";
  input String workdir = "<default>" "The output directory for imported FMU files.
↳<default> will put the files to current working directory.";
  input Integer loglevel = 3 "loglevel_nothing=0;loglevel_fatal=1;loglevel_error=2;
↳loglevel_warning=3;loglevel_info=4;loglevel_verbose=5;loglevel_debug=6";
  input Boolean fullPath = false "When true the full output path is returned,
↳otherwise only the file name.";
  input Boolean debugLogging = false "When true the FMU's debug output is printed.
↳";
```

(continues on next page)

(continued from previous page)

```

input Boolean generateInputConnectors = true "When true creates the input_
↪connector pins.";
input Boolean generateOutputConnectors = true "When true creates the output_
↪connector pins.";
output String generatedFileName "Returns the full path of the generated file.";
end importFMU;

```

24.1.161 importFMUModelDescription

Imports modelDescription.xml
 Example command:
 importFMUModelDescription("A.xml");

```

function importFMUModelDescription
  input String filename "the fmu file name";
  input String workdir = "<default>" "The output directory for imported FMU files.
↪<default> will put the files to current working directory.";
  input Integer loglevel = 3 "loglevel_nothing=0;loglevel_fatal=1;loglevel_error=2;
↪loglevel_warning=3;loglevel_info=4;loglevel_verbose=5;loglevel_debug=6";
  input Boolean fullPath = false "When true the full output path is returned_
↪otherwise only the file name.";
  input Boolean debugLogging = false "When true the FMU's debug output is printed.
↪";
  input Boolean generateInputConnectors = true "When true creates the input_
↪connector pins.";
  input Boolean generateOutputConnectors = true "When true creates the output_
↪connector pins.";
  output String generatedFileName "Returns the full path of the generated file.";
end importFMUModelDescription;

```

24.1.162 inferBindings

```

function inferBindings
  input TypeName path;
  output Boolean success;
end inferBindings;

```

24.1.163 installPackage

```
function installPackage
  input TypeName pkg;
  input String version = "";
  input Boolean exactMatch = false;
  output Boolean result;
end installPackage;
```

24.1.164 instantiateModel

Instantiates the `class` and returns the flat Modelica code.

```
function instantiateModel
  input TypeName className;
  output String result;
end instantiateModel;
```

24.1.165 isBlock

```
function isBlock
  input TypeName cl;
  output Boolean b;
end isBlock;
```

24.1.166 isClass

```
function isClass
  input TypeName cl;
  output Boolean b;
end isClass;
```

24.1.167 isConnector

```
function isConnector
  input TypeName cl;
  output Boolean b;
end isConnector;
```

24.1.168 isEnumeration

```
function isEnumeration
  input TypeName cl;
  output Boolean b;
end isEnumeration;
```

24.1.169 isExperiment

```
function isExperiment
  input TypeName name;
  output Boolean res;
end isExperiment;
```

24.1.170 isFunction

```
function isFunction
  input TypeName cl;
  output Boolean b;
end isFunction;
```

24.1.171 isModel

```
function isModel
  input TypeName cl;
  output Boolean b;
end isModel;
```

24.1.172 isOperator

```
function isOperator
  input TypeName cl;
  output Boolean b;
end isOperator;
```

24.1.173 isOperatorFunction

```
function isOperatorFunction
  input TypeName cl;
  output Boolean b;
end isOperatorFunction;
```

24.1.174 isOperatorRecord

```
function isOperatorRecord
  input TypeName cl;
  output Boolean b;
end isOperatorRecord;
```

24.1.175 isOptimization

```
function isOptimization
  input TypeName c1;
  output Boolean b;
end isOptimization;
```

24.1.176 isPackage

```
function isPackage
  input TypeName c1;
  output Boolean b;
end isPackage;
```

24.1.177 isPartial

```
function isPartial
  input TypeName c1;
  output Boolean b;
end isPartial;
```

24.1.178 isProtectedClass

```
function isProtectedClass
  input TypeName c1;
  input String c2;
  output Boolean b;
end isProtectedClass;
```

24.1.179 isRecord

```
function isRecord
  input TypeName c1;
  output Boolean b;
end isRecord;
```

24.1.180 isShortDefinition

```
returns true if the definition is a short class definition
```

```
function isShortDefinition
  input TypeName class_;
  output Boolean isShortCls;
end isShortDefinition;
```

24.1.181 isType

```
function isType
  input TypeName cl;
  output Boolean b;
end isType;
```

24.1.182 linearize

creates a **model with** symbolic linearization matrixes

```
function linearize
  input TypeName className "the class that should simulated";
  input Real startTime = "<default>" "the start time of the simulation. <default> ↵
↵= 0.0";
  input Real stopTime = 1.0 "the stop time of the simulation. <default> = 1.0";
  input Real numberOfIntervals = 500 "number of intervals in the result file.
↵<default> = 500";
  input Real stepSize = 0.002 "step size that is used for the result file.
↵<default> = 0.002";
  input Real tolerance = 1e-6 "tolerance used by the integration method. <default> ↵
↵= 1e-6";
  input String method = "<default>" "integration method used for simulation.
↵<default> = dassl";
  input String fileNamePrefix = "<default>" "fileNamePrefix. <default> = \"\"";
  input Boolean storeInTemp = false "storeInTemp. <default> = false";
  input Boolean noClean = false "noClean. <default> = false";
  input String options = "<default>" "options. <default> = \"\"";
  input String outputFormat = "mat" "Format for the result file. <default> = \"mat\
↵";
  input String variableFilter = ".*" "Filter for variables that should store in ↵
↵result file. <default> = \".*\\"";
  input String cflags = "<default>" "cflags. <default> = \"\"";
  input String simflags = "<default>" "simflags. <default> = \"\"";
  output String linearizationResult;
end linearize;
```

24.1.183 list

Lists the contents of the given **class**, or all loaded classes.

```
function list
  input TypeName class_ = $Code(AllLoadedClasses);
  input Boolean interfaceOnly = false;
  input Boolean shortOnly = false "only short class definitions";
  input ExportKind exportKind = ExportKind.Absyn;
  output String contents;
end list;
```

24.1.184 listFile

Lists the contents of the file given by the **class**.

```
function listFile
  input TypeName class_;
  input Boolean nestedClasses = true;
  output String contents;
end listFile;
```

24.1.185 listVariables

Lists the names of the active variables **in** the scripting environment.

```
function listVariables
  output TypeName variables[:];
end listVariables;
```

24.1.186 loadEncryptedPackage

```
function loadEncryptedPackage
  input String fileName;
  input String workdir = "<default>" "The output directory for imported encrypted_
↳files. <default> will put the files to current working directory.";
  input Boolean skipUnzip = false "Skips the unzip of .mol if true. In that case_
↳we expect the files are already extracted e.g., because of_
↳parseEncryptedPackage() call.";
  input Boolean uses = true;
  input Boolean notify = true "Give a notification of the libraries and versions_
↳that were loaded";
  input Boolean requireExactVersion = false "If the version is required to be_
↳exact, if there is a uses Modelica(version=\"3.2\"), Modelica 3.2.1 will not_
↳match it.";
  output Boolean success;
end loadEncryptedPackage;
```

24.1.187 loadFile

load file (*.mo) **and** merge it with the loaded AST.

```
function loadFile
  input String fileName;
  input String encoding = "UTF-8";
  input Boolean uses = true;
  input Boolean notify = true "Give a notification of the libraries and versions_
↳that were loaded";
  input Boolean requireExactVersion = false "If the version is required to be_
↳exact, if there is a uses Modelica(version=\"3.2\"), Modelica 3.2.1 will not_
↳match it.";
  output Boolean success;
end loadFile;
```

24.1.188 loadFileInteractive

```
function loadFileInteractive
  input String filename;
  input String encoding = "UTF-8";
  input Boolean uses = true;
  input Boolean notify = true "Give a notification of the libraries and versions_
↳that were loaded";
  input Boolean requireExactVersion = false "If the version is required to be_
↳exact, if there is a uses Modelica(version=\"3.2\"), Modelica 3.2.1 will not_
↳match it.";
  output TypeName names[:];
end loadFileInteractive;
```

24.1.189 loadFileInteractiveQualified

```
function loadFileInteractiveQualified
  input String filename;
  input String encoding = "UTF-8";
  output TypeName names[:];
end loadFileInteractiveQualified;
```

24.1.190 loadFiles

load files (*.mo) **and** merges them with the loaded AST.

```
function loadFiles
  input String[:] fileNames;
  input String encoding = "UTF-8";
  input Integer numThreads = OpenModelica.Scripting.numProcessors();
  input Boolean uses = true;
  input Boolean notify = true "Give a notification of the libraries and versions_
↳that were loaded";
  input Boolean requireExactVersion = false "If the version is required to be_
↳exact, if there is a uses Modelica(version=\"3.2\"), Modelica 3.2.1 will not_
↳match it.";
  output Boolean success;
end loadFiles;
```

24.1.191 loadModel

Loads the Modelica Standard Library.

```
function loadModel
  input TypeName className;
  input String[:] priorityVersion = {"default"};
  input Boolean notify = false "Give a notification of the libraries and versions_
↳that were loaded";
  input String languageStandard = "" "Override the set language standard. Parse_
↳with the given setting, but do not change it permanently.";
  input Boolean requireExactVersion = false "If the version is required to be_
↳exact, if there is a uses Modelica(version=\"3.2\"), Modelica 3.2.1 will not_
↳match it.";
  output Boolean success;
end loadModel;
```

24.1.192 loadModelica3D

```
function loadModelica3D
  input String version = "3.2.1";
  output Boolean status;
end loadModelica3D;
```

24.1.193 loadOMSimulator

loads the OMSimulator DLL from default path

```
function loadOMSimulator
  output Integer status;
end loadOMSimulator;
```

24.1.194 loadString

Parses the data **and** merges the resulting AST with the loaded AST.

If a filename is given, it is used to provide error-messages as **if** the string was read **in** binary format from a file with the same name.

The file is converted to UTF-8 from the given character set.

When merge is **true** the classes **cNew** **in** the file will be merged with the already

↳loaded classes **cOld** **in** the following way:

1. get all the **inner class definitions** from **cOld** that were loaded from a different, ↳file than itself
2. append all elements from step 1 to **class cNew public** list

NOTE: Encoding is deprecated as *ALL* strings are now UTF-8 encoded.

```
function loadString
  input String data;
  input String filename = "<interactive>";
  input String encoding = "UTF-8";
  input Boolean merge = false "if merge is true the parsed AST is merged with the, ↳existing AST, default to false which means that is replaced, not merged";
  output Boolean success;
end loadString;
```

24.1.195 mkdir

create directory of given path (which may be either relative **or** absolute)
returns **true** **if** directory was created **or** already exists.

```
function mkdir
  input String newDirectory;
  output Boolean success;
end mkdir;
```

24.1.196 moveClass

Moves a **class up or** down depending on the given offset, where a positive offset moves the **class down and** a negative offset up. The offset is truncated **if** the resulting index is outside the **class list**. It retains the visibility of the **class by** adding **public/protected** sections **when** needed, **and** merges sections of the same **type if** the **class is** moved from a section it was alone **in**. Returns **true if** the move was successful, otherwise **false**.

```
function moveClass
  input TypeName className "the class that should be moved";
  input Integer offset "Offset in the class list.";
  output Boolean result;
end moveClass;
```

24.1.197 moveClassToBottom

Moves a **class to** the bottom of its enclosing **class**. Returns **true if** the move was successful, otherwise **false**.

```
function moveClassToBottom
  input TypeName className;
  output Boolean result;
end moveClassToBottom;
```

24.1.198 moveClassToTop

Moves a **class to** the top of its enclosing **class**. Returns **true if** the move was successful, otherwise **false**.

```
function moveClassToTop
  input TypeName className;
  output Boolean result;
end moveClassToTop;
```

24.1.199 ngspicetoModelica

Converts ngspice netlist to Modelica code. Modelica file is created **in** the same_ ↵ directory as netlist file.

```
function ngspicetoModelica
  input String netlistfileName;
  output Boolean success = false;
end ngspicetoModelica;
```

24.1.200 numProcessors

```
function numProcessors
  output Integer result;
end numProcessors;
```

24.1.201 oms_RunFile

```
function oms_RunFile
  input String filename;
  output Integer status;
end oms_RunFile;
```

24.1.202 oms_addBus

```
function oms_addBus
  input String cref;
  output Integer status;
end oms_addBus;
```

24.1.203 oms_addConnection

```
function oms_addConnection
  input String crefA;
  input String crefB;
  output Integer status;
end oms_addConnection;
```

24.1.204 oms_addConnector

```
function oms_addConnector
  input String cref;
  input oms_causality causality;
  input oms_signal_type type_;
  output Integer status;
end oms_addConnector;
```

24.1.205 oms_addConnectorToBus

```
function oms_addConnectorToBus
  input String busCref;
  input String connectorCref;
  output Integer status;
end oms_addConnectorToBus;
```

24.1.206 oms_addConnectorToTLMBus

```
function oms_addConnectorToTLMBus
  input String busCref;
  input String connectorCref;
  input String type_;
  output Integer status;
end oms_addConnectorToTLMBus;
```

24.1.207 oms_addDynamicValueIndicator

```
function oms_addDynamicValueIndicator
  input String signal;
  input String lower;
  input String upper;
  input Real stepSize;
  output Integer status;
end oms_addDynamicValueIndicator;
```

24.1.208 oms_addEventIndicator

```
function oms_addEventIndicator
  input String signal;
  output Integer status;
end oms_addEventIndicator;
```

24.1.209 oms_addExternalModel

```
function oms_addExternalModel
  input String cref;
  input String path;
  input String startscript;
  output Integer status;
end oms_addExternalModel;
```

24.1.210 oms_addSignalsToResults

```
function oms_addSignalsToResults
  input String cref;
  input String regex;
  output Integer status;
end oms_addSignalsToResults;
```

24.1.211 oms_addStaticValueIndicator

```
function oms_addStaticValueIndicator
  input String signal;
  input Real lower;
  input Real upper;
  input Real stepSize;
  output Integer status;
end oms_addStaticValueIndicator;
```

24.1.212 oms_addSubModel

```
function oms_addSubModel
  input String cref;
  input String fmuPath;
  output Integer status;
end oms_addSubModel;
```

24.1.213 oms_addSystem

```
function oms_addSystem
  input String cref;
  input oms_system type_;
  output Integer status;
end oms_addSystem;
```

24.1.214 oms_addTLMBus

```
function oms_addTLMBus
  input String cref;
  input oms_tlm_domain domain;
  input Integer dimensions;
  input oms_tlm_interpolation interpolation;
  output Integer status;
end oms_addTLMBus;
```

24.1.215 oms_addTLMConnection

```
function oms_addTLMConnection
  input String crefA;
  input String crefB;
  input Real delay;
  input Real alpha;
  input Real linearimpedance;
  input Real angularimpedance;
  output Integer status;
end oms_addTLMConnection;
```

24.1.216 oms_addTimeIndicator

```
function oms_addTimeIndicator
  input String signal;
  output Integer status;
end oms_addTimeIndicator;
```

24.1.217 oms_cancelSimulation_asynchronous

```
function oms_cancelSimulation_asynchronous
  input String cref;
  output Integer status;
end oms_cancelSimulation_asynchronous;
```

24.1.218 oms_compareSimulationResults

```
function oms_compareSimulationResults
  input String filenameA;
  input String filenameB;
  input String var;
  input Real relTol;
  input Real absTol;
  output Integer status;
end oms_compareSimulationResults;
```

24.1.219 oms_copySystem

```
function oms_copySystem
  input String source;
  input String target;
  output Integer status;
end oms_copySystem;
```

24.1.220 oms_delete

```
function oms_delete
  input String cref;
  output Integer status;
end oms_delete;
```

24.1.221 oms_deleteConnection

```
function oms_deleteConnection
  input String crefA;
  input String crefB;
  output Integer status;
end oms_deleteConnection;
```

24.1.222 oms_deleteConnectorFromBus

```
function oms_deleteConnectorFromBus
  input String busCref;
  input String connectorCref;
  output Integer status;
end oms_deleteConnectorFromBus;
```

24.1.223 oms_deleteConnectorFromTLMBus

```
function oms_deleteConnectorFromTLMBus
  input String busCref;
  input String connectorCref;
  output Integer status;
end oms_deleteConnectorFromTLMBus;
```

24.1.224 oms_export

```
function oms_export
  input String cref;
  input String filename;
  output Integer status;
end oms_export;
```

24.1.225 oms_exportDependencyGraphs

```
function oms_exportDependencyGraphs
  input String cref;
  input String initialization;
  input String simulation;
  output Integer status;
end oms_exportDependencyGraphs;
```

24.1.226 oms_extractFMKind

```
function oms_extractFMKind
  input String filename;
  output Integer kind;
  output Integer status;
end oms_extractFMKind;
```

24.1.227 oms_faultInjection

```
function oms_faultInjection
  input String signal;
  input oms_fault_type faultType;
  input Real faultValue;
  output Integer status;
end oms_faultInjection;
```

24.1.228 oms_getBoolean

```
function oms_getBoolean
  input String cref;
  output Boolean value;
  output Integer status;
end oms_getBoolean;
```

24.1.229 oms_getFixedStepSize

```
function oms_getFixedStepSize
  input String cref;
  output Real stepSize;
  output Integer status;
end oms_getFixedStepSize;
```

24.1.230 oms_getInteger

```
function oms_getInteger
  input String cref;
  input Integer value;
  output Integer status;
end oms_getInteger;
```

24.1.231 oms_getModelState

```
function oms_getModelState
  input String cref;
  output Integer modelState;
  output Integer status;
end oms_getModelState;
```

24.1.232 oms_getReal

```
function oms_getReal
  input String cref;
  output Real value;
  output Integer status;
end oms_getReal;
```

24.1.233 oms_getSolver

```
function oms_getSolver
  input String cref;
  output Integer solver;
  output Integer status;
end oms_getSolver;
```

24.1.234 oms_getStartTime

```
function oms_getStartTime
  input String cref;
  output Real startTime;
  output Integer status;
end oms_getStartTime;
```

24.1.235 oms_getStopTime

```
function oms_getStopTime
  input String cref;
  output Real stopTime;
  output Integer status;
end oms_getStopTime;
```

24.1.236 oms_getSubModelPath

```
function oms_getSubModelPath
  input String cref;
  output String path;
  output Integer status;
end oms_getSubModelPath;
```

24.1.237 oms_getSystemType

```
function oms_getSystemType
  input String cref;
  output Integer type_;
  output Integer status;
end oms_getSystemType;
```

24.1.238 oms_getTolerance

```
function oms_getTolerance
  input String cref;
  output Real absoluteTolerance;
  output Real relativeTolerance;
  output Integer status;
end oms_getTolerance;
```

24.1.239 oms_getVariableStepSize

```
function oms_getVariableStepSize
  input String cref;
  output Real initialStepSize;
  output Real minimumStepSize;
  output Real maximumStepSize;
  output Integer status;
end oms_getVariableStepSize;
```

24.1.240 oms_getVersion

Returns the version of the OMSimulator.

```
function oms_getVersion
  output String version;
end oms_getVersion;
```

24.1.241 oms_importFile

```
function oms_importFile
  input String filename;
  output String cref;
  output Integer status;
end oms_importFile;
```

24.1.242 oms_initialize

```
function oms_initialize
  input String cref;
  output Integer status;
end oms_initialize;
```

24.1.243 oms_instantiate

```
function oms_instantiate
  input String cref;
  output Integer status;
end oms_instantiate;
```

24.1.244 oms_list

```
function oms_list
  input String cref;
  output String contents;
  output Integer status;
end oms_list;
```

24.1.245 oms_listUnconnectedConnectors

```
function oms_listUnconnectedConnectors
  input String cref;
  output String contents;
  output Integer status;
end oms_listUnconnectedConnectors;
```

24.1.246 oms_loadSnapshot

```
function oms_loadSnapshot
  input String cref;
  input String snapshot;
  output Integer status;
end oms_loadSnapshot;
```

24.1.247 oms_newModel

```
function oms_newModel
  input String cref;
  output Integer status;
end oms_newModel;
```

24.1.248 oms_parseModelName

```
function oms_parseModelName
  input String contents;
  output String cref;
  output Integer status;
end oms_parseModelName;
```

24.1.249 oms_removeSignalsFromResults

```
function oms_removeSignalsFromResults
  input String cref;
  input String regex;
  output Integer status;
end oms_removeSignalsFromResults;
```

24.1.250 oms_rename

```
function oms_rename
  input String cref;
  input String newCref;
  output Integer status;
end oms_rename;
```

24.1.251 oms_reset

```
function oms_reset
  input String cref;
  output Integer status;
end oms_reset;
```

24.1.252 oms_setBoolean

```
function oms_setBoolean
  input String cref;
  input Boolean value;
  output Integer status;
end oms_setBoolean;
```

24.1.253 oms_setCommandLineOption

```
function oms_setCommandLineOption
  input String cmd;
  output Integer status;
end oms_setCommandLineOption;
```

24.1.254 oms_setFixedStepSize

```
function oms_setFixedStepSize
  input String cref;
  input Real stepSize;
  output Integer status;
end oms_setFixedStepSize;
```

24.1.255 oms_setInteger

```
function oms_setInteger
  input String cref;
  input Integer value;
  output Integer status;
end oms_setInteger;
```

24.1.256 oms_setLogFile

```
function oms_setLogFile
  input String filename;
  output Integer status;
end oms_setLogFile;
```

24.1.257 oms_setLoggingInterval

```
function oms_setLoggingInterval
  input String cref;
  input Real loggingInterval;
  output Integer status;
end oms_setLoggingInterval;
```

24.1.258 oms_setLoggingLevel

```
function oms_setLoggingLevel
  input Integer logLevel;
  output Integer status;
end oms_setLoggingLevel;
```

24.1.259 oms_setReal

```
function oms_setReal
  input String cref;
  input Real value;
  output Integer status;
end oms_setReal;
```

24.1.260 oms_setRealInputDerivative

```
function oms_setRealInputDerivative
  input String cref;
  input Real value;
  output Integer status;
end oms_setRealInputDerivative;
```

24.1.261 oms_setResultFile

```
function oms_setResultFile
  input String cref;
  input String filename;
  input Integer bufferSize;
  output Integer status;
end oms_setResultFile;
```

24.1.262 oms_setSignalFilter

```
function oms_setSignalFilter
  input String cref;
  input String regex;
  output Integer status;
end oms_setSignalFilter;
```

24.1.263 oms_setSolver

```
function oms_setSolver
  input String cref;
  input oms_solver solver;
  output Integer status;
end oms_setSolver;
```

24.1.264 oms_setStartTime

```
function oms_setStartTime
  input String cref;
  input Real startTime;
  output Integer status;
end oms_setStartTime;
```

24.1.265 oms_setStopTime

```
function oms_setStopTime
  input String cref;
  input Real stopTime;
  output Integer status;
end oms_setStopTime;
```

24.1.266 oms_setTLMPositionAndOrientation

```
function oms_setTLMPositionAndOrientation
  input String cref;
  input Real x1;
  input Real x2;
  input Real x3;
  input Real A11;
  input Real A12;
  input Real A13;
  input Real A21;
  input Real A22;
  input Real A23;
  input Real A31;
  input Real A32;
  input Real A33;
  output Integer status;
end oms_setTLMPositionAndOrientation;
```

24.1.267 oms_setTLMSocketData

```
function oms_setTLMSocketData
  input String cref;
  input String address;
  input Integer managerPort;
  input Integer monitorPort;
  output Integer status;
end oms_setTLMSocketData;
```

24.1.268 oms_setTempDirectory

```
function oms_setTempDirectory
  input String newTempDir;
  output Integer status;
end oms_setTempDirectory;
```

24.1.269 oms_setTolerance

```
function oms_setTolerance
  input String cref;
  input Real absoluteTolerance;
  input Real relativeTolerance;
  output Integer status;
end oms_setTolerance;
```

24.1.270 oms_setVariableStepSize

```
function oms_setVariableStepSize
  input String cref;
  input Real initialStepSize;
  input Real minimumStepSize;
  input Real maximumStepSize;
  output Integer status;
end oms_setVariableStepSize;
```

24.1.271 oms_setWorkingDirectory

```
function oms_setWorkingDirectory
  input String newWorkingDir;
  output Integer status;
end oms_setWorkingDirectory;
```

24.1.272 oms_simulate

```
function oms_simulate
  input String cref;
  output Integer status;
end oms_simulate;
```

24.1.273 oms_stepUntil

```
function oms_stepUntil
  input String cref;
  input Real stopTime;
  output Integer status;
end oms_stepUntil;
```

24.1.274 oms_terminate

```
function oms_terminate
  input String cref;
  output Integer status;
end oms_terminate;
```

24.1.275 optimize

optimize a modelica/optimica **model** by generating c code, build it **and** run the optimization executable.

The only required argument is the className, **while** all others have some default values.

```
simulate(className, [startTime], [stopTime], [numberOfIntervals], [stepSize],
  ↳[tolerance], [fileNamePrefix], [options], [outputFormat], [variableFilter],
  ↳[cflags], [simflags])
```

Example command:

```
simulate(A);
```

```
function optimize
  input TypeName className "the class that should simulated";
  input Real startTime = "<default>" "the start time of the simulation. <default>
  ↳= 0.0";
  input Real stopTime = 1.0 "the stop time of the simulation. <default> = 1.0";
  input Real numberOfIntervals = 500 "number of intervals in the result file.
  ↳<default> = 500";
  input Real stepSize = 0.002 "step size that is used for the result file.
  ↳<default> = 0.002";
  input Real tolerance = 1e-6 "tolerance used by the integration method. <default>
  ↳= 1e-6";
  input String method = DAE.SCONST("optimization") "optimize a modelica/optimica
  ↳model.";
  input String fileNamePrefix = "<default>" "fileNamePrefix. <default> = \"\"";
  input Boolean storeInTemp = false "storeInTemp. <default> = false";
  input Boolean noClean = false "noClean. <default> = false";
  input String options = "<default>" "options. <default> = \"\"";
  input String outputFormat = "mat" "Format for the result file. <default> = \"mat\
  ↳\"";
  input String variableFilter = ".*" "Filter for variables that should store in
  ↳result file. <default> = \".*\\"";
  input String cflags = "<default>" "cflags. <default> = \"\"";
  input String simflags = "<default>" "simflags. <default> = \"\"";
  output String optimizationResults;
end optimize;
```

24.1.276 parseEncryptedPackage

```
function parseEncryptedPackage
  input String fileName;
  input String workdir = "<default>" "The output directory for imported encrypted
  ↳files. <default> will put the files to current working directory.";
  output TypeName names[:];
end parseEncryptedPackage;
```

24.1.277 parseFile

```
function parseFile
  input String filename;
  input String encoding = "UTF-8";
  output TypeName names[:];
end parseFile;
```

24.1.278 parseString

```
function parseString
  input String data;
  input String filename = "<interactive>";
  output TypeName names[:];
end parseString;
```

24.1.279 plot

Launches a plot window using OMPlot.

```
function plot
  input VariableNames vars "The variables you want to plot";
  input Boolean externalWindow = false "Opens the plot in a new plot window";
  input String fileName = "<default>" "The filename containing the variables.
↳<default> will read the last simulation result";
  input String title = "" "This text will be used as the diagram title.";
  input String grid = "detailed" "Sets the grid for the plot i.e simple, detailed,
↳none.";
  input Boolean logX = false "Determines whether or not the horizontal axis is
↳logarithmically scaled.";
  input Boolean logY = false "Determines whether or not the vertical axis is
↳logarithmically scaled.";
  input String xLabel = "time" "This text will be used as the horizontal label in
↳the diagram.";
  input String yLabel = "" "This text will be used as the vertical label in the
↳diagram.";
  input Real xRange[2] = {0.0, 0.0} "Determines the horizontal interval that is
↳visible in the diagram. {0,0} will select a suitable range.";
  input Real yRange[2] = {0.0, 0.0} "Determines the vertical interval that is
↳visible in the diagram. {0,0} will select a suitable range.";
  input Real curveWidth = 1.0 "Sets the width of the curve.";
  input Integer curveStyle = 1 "Sets the style of the curve. SolidLine=1,
↳DashLine=2, DotLine=3, DashDotLine=4, DashDotDotLine=5, Sticks=6, Steps=7.";
  input String legendPosition = "top" "Sets the POSITION of the legend i.e left,
↳right, top, bottom, none.";
  input String footer = "" "This text will be used as the diagram footer.";
  input Boolean autoScale = true "Use auto scale while plotting.";
  input Boolean forceOMPlot = false "if true launches OMPlot and doesn't call
↳callback function even if it is defined.";
  output Boolean success "Returns true on success";
end plot;
```

24.1.280 plotAll

Works **in** the same way as `plot()`, but does **not** accept any variable names as **input**. Instead, all variables are part of the plot window.

Example command sequences:

```
simulate(A);plotAll();
simulate(A);plotAll(externalWindow=true);
simulate(A,fileNamePrefix="B");simulate(C);plotAll(x,fileName="B.mat");
```

```
function plotAll
  input Boolean externalWindow = false "Opens the plot in a new plot window";
  input String fileName = "<default>" "The filename containing the variables.
  ↳<default> will read the last simulation result";
  input String title = "" "This text will be used as the diagram title.";
  input String grid = "detailed" "Sets the grid for the plot i.e simple, detailed,
  ↳none.";
  input Boolean logX = false "Determines whether or not the horizontal axis is
  ↳logarithmically scaled.";
  input Boolean logY = false "Determines whether or not the vertical axis is
  ↳logarithmically scaled.";
  input String xLabel = "time" "This text will be used as the horizontal label in
  ↳the diagram.";
  input String yLabel = "" "This text will be used as the vertical label in the
  ↳diagram.";
  input Real xRange[2] = {0.0, 0.0} "Determines the horizontal interval that is
  ↳visible in the diagram. {0,0} will select a suitable range.";
  input Real yRange[2] = {0.0, 0.0} "Determines the vertical interval that is
  ↳visible in the diagram. {0,0} will select a suitable range.";
  input Real curveWidth = 1.0 "Sets the width of the curve.";
  input Integer curveStyle = 1 "Sets the style of the curve. SolidLine=1,
  ↳DashLine=2, DotLine=3, DashDotLine=4, DashDotDotLine=5, Sticks=6, Steps=7.";
  input String legendPosition = "top" "Sets the POSITION of the legend i.e left,
  ↳right, top, bottom, none.";
  input String footer = "" "This text will be used as the diagram footer.";
  input Boolean autoScale = true "Use auto scale while plotting.";
  input Boolean forceOMPlot = false "if true launches OMPlot and doesn't call
  ↳callback function even if it is defined.";
  output Boolean success "Returns true on success";
end plotAll;
```

24.1.281 plotParametric

Launches a `plotParametric` window using `OMPlot`. Returns **true** on success.

Example command sequences:

```
simulate(A);plotParametric(x,y);
simulate(A);plotParametric(x,y, externalWindow=true);
```

```
function plotParametric
  input VariableName xVariable;
  input VariableName yVariable;
  input Boolean externalWindow = false "Opens the plot in a new plot window";
  input String fileName = "<default>" "The filename containing the variables.
  ↳<default> will read the last simulation result";
  input String title = "" "This text will be used as the diagram title.";
  input String grid = "detailed" "Sets the grid for the plot i.e simple, detailed,
  ↳none.";
  input Boolean logX = false "Determines whether or not the horizontal axis is
  ↳logarithmically scaled.";
  input Boolean logY = false "Determines whether or not the vertical axis is
  ↳logarithmically scaled.";
```

(continues on next page)

(continued from previous page)

```

    input String xlabel = "time" "This text will be used as the horizontal label in
↳the diagram.";
    input String ylabel = "" "This text will be used as the vertical label in the
↳diagram.";
    input Real xrange[2] = {0.0, 0.0} "Determines the horizontal interval that is
↳visible in the diagram. {0,0} will select a suitable range.";
    input Real yrange[2] = {0.0, 0.0} "Determines the vertical interval that is
↳visible in the diagram. {0,0} will select a suitable range.";
    input Real curveWidth = 1.0 "Sets the width of the curve.";
    input Integer curveStyle = 1 "Sets the style of the curve. SolidLine=1,
↳DashLine=2, DotLine=3, DashDotLine=4, DashDotDotLine=5, Sticks=6, Steps=7.";
    input String legendPosition = "top" "Sets the POSITION of the legend i.e left,
↳right, top, bottom, none.";
    input String footer = "" "This text will be used as the diagram footer.";
    input Boolean autoScale = true "Use auto scale while plotting.";
    input Boolean forceOMPlot = false "if true launches OMPlot and doesn't call
↳callback function even if it is defined.";
    output Boolean success "Returns true on success";
end plotParametric;

```

24.1.282 readFile

The contents of the given file are returned.
 Note that **if the function fails**, the error message is returned as a string instead
 ↳of multiple **output or** similar.

```

impure function readFile
  input String fileName;
  output String contents;
end readFile;

```

24.1.283 readFileNoNumeric

Returns the contents of the file, with anything resembling a (real) number
 ↳stripped out, and at the end adding:
 Filter count from number domain: n.
 This should probably be changed to multiple outputs; the filtered string and an
 ↳integer.
 Does anyone use this API call?

```

function readFileNoNumeric
  input String fileName;
  output String contents;
end readFileNoNumeric;

```

24.1.284 readSimulationResult

Reads a result file, returning a `matrix` corresponding to the variables `and size` given.

```
function readSimulationResult
  input String filename;
  input VariableNames variables;
  input Integer size = 0 "0=read any size... If the size is not the same as the
  result-file, this function fails";
  output Real result[:, :];
end readSimulationResult;
```

24.1.285 readSimulationResultSize

The number of intervals that are present `in` the `output` file.

```
function readSimulationResultSize
  input String fileName;
  output Integer sz;
end readSimulationResultSize;
```

24.1.286 readSimulationResultVars

Returns the variables `in` the simulation file; you can use `val()` `and` `plot()` commands using these names.

```
function readSimulationResultVars
  input String fileName;
  input Boolean readParameters = true;
  input Boolean openmodelicaStyle = false;
  output String[:] vars;
end readSimulationResultVars;
```

24.1.287 realpath

Get full path name of file `or` directory name

```
function realpath
  input String name "Absolute or relative file or directory name";
  output String fullName "Full path of 'name'";
end realpath;
```

24.1.288 reduceTerms

reduce terms.

```

function reduceTerms
  input TypeName className "the class that should be built";
  input Real startTime = 0.0 "the start time of the simulation. <default> = 0.0";
  input Real stopTime = 1.0 "the stop time of the simulation. <default> = 1.0";
  input Integer numberOfIntervals = 500 "number of intervals in the result file.
↪<default> = 500";
  input Real tolerance = 1e-6 "tolerance used by the integration method. <default> ↪
↪= 1e-6";
  input String method = "dassl" "integration method used for simulation. <default> ↪
↪= dassl";
  input String fileNamePrefix = "" "fileNamePrefix. <default> = \"\"";
  input String options = "" "options. <default> = \"\"";
  input String outputFormat = "mat" "Format for the result file. <default> = \"mat\
↪\"";
  input String variableFilter = ".*" "Filter for variables that should store in ↪
↪result file. <default> = \".*\\"";
  input String cflags = "" "cflags. <default> = \"\"";
  input String simflags = "" "simflags. <default> = \"\"";
  input String labelstoCancel = "";
  output String[2] buildModelResults;
end reduceTerms;

```

24.1.289 regex

Sets the error buffer **and** returns -1 **if** the regex does **not** compile.

The returned result is the same as POSIX regex():

The first value is the complete matched string

The rest are the substrings that you wanted.

For example:

```
regex(lorem, " \([A-Za-z]*\) \([A-Za-z]*\) ",maxMatches=3)
```

```
=> {" ipsum dolor ", "ipsum", "dolor" }
```

This means **if** you have n groups, you want maxMatches=n+1

```

function regex
  input String str;
  input String re;
  input Integer maxMatches = 1 "The maximum number of matches that will be returned
↪";
  input Boolean extended = true "Use POSIX extended or regular syntax";
  input Boolean caseInsensitive = false;
  output Integer numMatches "-1 is an error, 0 means no match, else returns a ↪
↪number 1..maxMatches";
  output String matchedSubstrings[maxMatches] "unmatched strings are returned as ↪
↪empty";
end regex;

```

24.1.290 regexBool

Returns **true** if the string matches the regular expression.

```

function regexBool
  input String str;
  input String re;
  input Boolean extended = true "Use POSIX extended or regular syntax";
  input Boolean caseInsensitive = false;
  output Boolean matches;
end regexBool;

```

24.1.291 regularFileExists

```

function regularFileExists
  input String fileName;
  output Boolean exists;
end regularFileExists;

```

24.1.292 reloadClass

reloads the file associated with the given (loaded **class**)

```

function reloadClass
  input TypeName name;
  input String encoding = "UTF-8";
  output Boolean success;
end reloadClass;

```

24.1.293 remove

removes a file **or** directory of given path (which may be either relative **or** ↪absolute).

```

function remove
  input String path;
  output Boolean success "Returns true on success.";
end remove;

```

24.1.294 removeComponentModifiers

```

function removeComponentModifiers
  input TypeName class_;
  input String componentName;
  input Boolean keepRedeclares = false;
  output Boolean success;
end removeComponentModifiers;

```

24.1.295 removeElementModifiers

```
function removeElementModifiers
  input TypeName className;
  input String componentName;
  input Boolean keepRedeclares = false;
  output Boolean success;
end removeElementModifiers;
```

24.1.296 removeExtendsModifiers

```
function removeExtendsModifiers
  input TypeName className;
  input TypeName baseClassName;
  input Boolean keepRedeclares = false;
  output Boolean success;
end removeExtendsModifiers;
```

24.1.297 reopenStandardStream

```
function reopenStandardStream
  input StandardStream _stream;
  input String filename;
  output Boolean success;
end reopenStandardStream;
```

24.1.298 rewriteBlockCall

Function **for** property modeling, transforms **block calls** into instantiations **for** a ↵
↵loaded **model**

```
function rewriteBlockCall
  input TypeName className;
  input TypeName inDefs;
  output Boolean success;
end rewriteBlockCall;
```

24.1.299 runOpenTURNPythonScript

runs OpenTURNS with the given python script returning the log file

```
function runOpenTURNPythonScript
  input String pythonScriptFile;
  output String logOutputFile;
end runOpenTURNPythonScript;
```

24.1.300 runScript

Runs the mos-script specified by the filename.

```
impure function runScript
  input String fileName "*.mos";
  output String result;
end runScript;
```

24.1.301 runScriptParallel

```
function runScriptParallel
  input String scripts[:];
  input Integer numThreads = numProcessors();
  input Boolean useThreads = false;
  output Boolean results[:];
end runScriptParallel;
```

24.1.302 save

```
function save
  input TypeName className;
  output Boolean success;
end save;
```

24.1.303 saveAll

save the entire loaded AST to file.

```
function saveAll
  input String fileName;
  output Boolean success;
end saveAll;
```

24.1.304 saveModel

```
function saveModel
  input String fileName;
  input TypeName className;
  output Boolean success;
end saveModel;
```

24.1.305 saveTotalModel

Save the className **model** in a single file, together with all the other classes that it depends upon, directly **and** indirectly. This file can be later reloaded with the loadFile() API **function**, which loads className **and** all the other needed classes into memory. This is useful to allow third parties to run a certain **model** (e.g. **for** debugging) without worrying about all the library dependencies. Please note that SaveTotal file is **not** a valid Modelica .mo file according to the specification, **and** cannot be loaded in OMEdit - it can only be loaded with `loadFile()`.

```
function saveTotalModel
  input String fileName;
  input TypeName className;
  input Boolean stripAnnotations = false;
  input Boolean stripComments = false;
  output Boolean success;
end saveTotalModel;
```

24.1.306 saveTotalSCode

24.1.307 searchClassNames

Searches **for** the **class name** in the all the loaded classes. Example command:
searchClassNames("ground");
searchClassNames("ground", true);

```
function searchClassNames
  input String searchText;
  input Boolean findInText = false;
  output TypeName classNames[:];
end searchClassNames;
```

24.1.308 setAnnotationVersion

Sets the **annotation** version.

```
function setAnnotationVersion
  input String annotationVersion;
  output Boolean success;
end setAnnotationVersion;
```

24.1.309 setCFlags

CFLAGS

```
function setCFlags
  input String inString;
  output Boolean success;
end setCFlags;
```

24.1.310 setCXXCompiler

CXX

```
function setCXXCompiler
  input String compiler;
  output Boolean success;
end setCXXCompiler;
```

24.1.311 setCheapMatchingAlgorithm

example **input**: 3

```
function setCheapMatchingAlgorithm
  input Integer matchingAlgorithm;
  output Boolean success;
end setCheapMatchingAlgorithm;
```

24.1.312 setClassComment

Sets the **class comment**.

```
function setClassComment
  input TypeName class_;
  input String filename;
  output Boolean success;
end setClassComment;
```

24.1.313 setCommandLineOptions

The **input** is a regular command-line flag given to OMC, e.g. `-d=failtrace` **or** `-↵g=MetaModelica`

```
function setCommandLineOptions
  input String option;
  output Boolean success;
end setCommandLineOptions;
```

24.1.314 setCompileCommand

```
function setCompileCommand
  input String compileCommand;
  output Boolean success;
end setCompileCommand;
```

24.1.315 setCompiler

CC

```
function setCompiler
  input String compiler;
  output Boolean success;
end setCompiler;
```

24.1.316 setCompilerFlags

```
function setCompilerFlags
  input String compilerFlags;
  output Boolean success;
end setCompilerFlags;
```

24.1.317 setCompilerPath

```
function setCompilerPath
  input String compilerPath;
  output Boolean success;
end setCompilerPath;
```

24.1.318 setDebugFlags

example **input**: failtrace, -noevalfunc

```
function setDebugFlags
  input String debugFlags;
  output Boolean success;
end setDebugFlags;
```

24.1.319 setDefaultOpenCLDevice

Sets the default OpenCL device to be used.

```
function setDefaultOpenCLDevice
  input Integer defdevid;
  output Boolean success;
end setDefaultOpenCLDevice;
```

24.1.320 setDocumentationAnnotation

```
function setDocumentationAnnotation
  input TypeName class_;
  input String info = "";
  input String revisions = "";
  output Boolean bool;
end setDocumentationAnnotation;
```

24.1.321 setEnvironmentVar

```
function setEnvironmentVar
  input String var;
  input String value;
  output Boolean success;
end setEnvironmentVar;
```

24.1.322 setIndexReductionMethod

example `input`: `dynamicStateSelection`

```
function setIndexReductionMethod
  input String method;
  output Boolean success;
end setIndexReductionMethod;
```

24.1.323 setInitXmlStartValue

```
function setInitXmlStartValue
  input String fileName;
  input String variableName;
  input String startValue;
  input String outputFile;
  output Boolean success = false;
end setInitXmlStartValue;
```

24.1.324 setInstallationDirectoryPath

Sets the OPENMODELICAHOME environment variable. Use this method instead of `↪setEnvironmentVar`.

```
function setInstallationDirectoryPath
  input String installationDirectoryPath;
  output Boolean success;
end setInstallationDirectoryPath;
```

24.1.325 setLanguageStandard

Sets the Modelica Language Standard.

```
function setLanguageStandard
  input String inVersion;
  output Boolean success;
end setLanguageStandard;
```

24.1.326 setLinker

```
function setLinker
  input String linker;
  output Boolean success;
end setLinker;
```

24.1.327 setLinkerFlags

```
function setLinkerFlags
  input String linkerFlags;
  output Boolean success;
end setLinkerFlags;
```

24.1.328 setMatchingAlgorithm

```
example input: omc
```

```
function setMatchingAlgorithm
  input String matchingAlgorithm;
  output Boolean success;
end setMatchingAlgorithm;
```

24.1.329 setModelicaPath

The Modelica Library Path - MODELICAPATH **in** the language specification; ↵
↔ OPENMODELICALIBRARY **in** OpenModelica.

```
function setModelicaPath
  input String modelicaPath;
  output Boolean success;
end setModelicaPath;
```

24.1.330 setNoSimplify

Sets the noSimplify flag.

```
function setNoSimplify
  input Boolean noSimplify;
  output Boolean success;
end setNoSimplify;
```

24.1.331 setOrderConnections

Sets the orderConnection flag.

```

function setOrderConnections
  input Boolean orderConnections;
  output Boolean success;
end setOrderConnections;

```

24.1.332 setPlotCommand

```

function setPlotCommand
  input String plotCommand;
  output Boolean success;
end setPlotCommand;

```

24.1.333 setPostOptModules

example **input**: lateInline, inlineArrayEqn, removeSimpleEquations.

```

function setPostOptModules
  input String modules;
  output Boolean success;
end setPostOptModules;

```

24.1.334 setPreOptModules

example **input**: removeFinalParameters, removeSimpleEquations, expandDerOperator

```

function setPreOptModules
  input String modules;
  output Boolean success;
end setPreOptModules;

```

24.1.335 setShowAnnotations

```

function setShowAnnotations
  input Boolean show;
  output Boolean success;
end setShowAnnotations;

```

24.1.336 setSourceFile

```

function setSourceFile
  input TypeName class_;
  input String filename;
  output Boolean success;
end setSourceFile;

```

24.1.337 setTearingMethod

```
example input: omcTearing
```

```
function setTearingMethod
  input String tearingMethod;
  output Boolean success;
end setTearingMethod;
```

24.1.338 setTempDirectoryPath

```
function setTempDirectoryPath
  input String tempDirectoryPath;
  output Boolean success;
end setTempDirectoryPath;
```

24.1.339 setVectorizationLimit

```
function setVectorizationLimit
  input Integer vectorizationLimit;
  output Boolean success;
end setVectorizationLimit;
```

24.1.340 simulate

simulates a modelica **model** by generating c code, build it **and** run the simulation, executable.

The only required argument is the className, **while** all others have some default values.

```
simulate(className, [startTime], [stopTime], [numberOfIntervals], [tolerance],
  [method], [fileNamePrefix], [options], [outputFormat], [variableFilter],
  [cflags], [simflags])
```

Example command:

```
simulate(A);
```

```
function simulate
  input TypeName className "the class that should simulated";
  input Real startTime = "<default>" "the start time of the simulation. <default>
  => 0.0";
  input Real stopTime = 1.0 "the stop time of the simulation. <default> = 1.0";
  input Real numberOfIntervals = 500 "number of intervals in the result file.
  <default> = 500";
  input Real tolerance = 1e-6 "tolerance used by the integration method. <default>
  => 1e-6";
  input String method = "<default>" "integration method used for simulation.
  <default> = dassl";
  input String fileNamePrefix = "<default>" "fileNamePrefix. <default> = \"\"";
  input String options = "<default>" "options. <default> = \"\"";
  input String outputFormat = "mat" "Format for the result file. <default> = \"mat\"";
  input String variableFilter = ".*" "Filter for variables that should store in
  result file. <default> = \".*\\"";
  input String cflags = "<default>" "cflags. <default> = \"\"";
  input String simflags = "<default>" "simflags. <default> = \"\"";
  output SimulationResult simulationResults;
```

(continues on next page)

(continued from previous page)

```

record SimulationResult
  String resultFile;
  String simulationOptions;
  String messages;
  Real timeFrontend;
  Real timeBackend;
  Real timeSimCode;
  Real timeTemplates;
  Real timeCompile;
  Real timeSimulation;
  Real timeTotal;
end SimulationResult;
end simulate;

```

24.1.341 solveLinearSystem

Solve $A \cdot X = B$, using dgesv or lp_solve (if any variable in X is integer)
 Returns for solver dgesv: info>0: Singular for element i. info<0: Bad input.
 For solver lp_solve: ???

```

function solveLinearSystem
  input Real[size(B, 1), size(B, 1)] A;
  input Real[:] B;
  input LinearSystemSolver solver = LinearSystemSolver.dgesv;
  input Integer[:] isInt = {-1} "list of indices that are integers";
  output Real[size(B, 1)] X;
  output Integer info;
end solveLinearSystem;

```

24.1.342 sortStrings

```

function sortStrings
  input String arr[:];
  output String sorted[:];
end sortStrings;

```

24.1.343 stat

```
impure function stat
  input String fileName;
  output Boolean success;
  output Real fileSize;
  output Real mtime;
end stat;
```

24.1.344 stringReplace

```
function stringReplace
  input String str;
  input String source;
  input String target;
  output String res;
end stringReplace;
```

24.1.345 stringSplit

Splits the string at the places given by the character

```
function stringSplit
  input String string;
  input String token "single character only";
  output String[:] strings;
end stringSplit;
```

24.1.346 stringTypeName

```
function stringTypeName
  input String str;
  output TypeName cl;
end stringTypeName;
```

24.1.347 stringVariableName

```
function stringVariableName
  input String str;
  output VariableName cl;
end stringVariableName;
```

24.1.348 strtok

Splits the strings at the places given by the token, **for** example:
strtok("abcdbdef", "b") => {"a", "c", "def"}
strtok("abcdbdef", "cd") => {"ab", "ef"}

```
function strtok
  input String string;
  input String token;
```

(continues on next page)

(continued from previous page)

```

output String[:] strings;
end strtok;

```

24.1.349 system

Similar to `system(3)`. Executes the given command `in` the system shell.

```

impure function system
  input String callStr "String to call: sh -c $callStr";
  input String outputFile = "" "The output is redirected to this file (unless
↪already done by callStr)";
  output Integer retval "Return value of the system call; usually 0 on success";
end system;

```

24.1.350 system_parallel

Similar to `system(3)`. Executes the given commands `in` the system shell, `in parallel`,
↪`if` omc was compiled using OpenMP.

```

impure function system_parallel
  input String callStr[:] "String to call: sh -c $callStr";
  input Integer numThreads = numProcessors();
  output Integer retval[:] "Return value of the system call; usually 0 on success";
end system_parallel;

```

24.1.351 testsuiteFriendlyName

```

function testsuiteFriendlyName
  input String path;
  output String fixed;
end testsuiteFriendlyName;

```

24.1.352 threadWorkFailed

24.1.353 translateGraphics

```

function translateGraphics
  input TypeName className;
  output String result;
end translateGraphics;

```

24.1.354 translateModelFMU

translates a modelica **model** into a Functional Mockup Unit. The only required argument is the **className**, while all others have some default values.

Example command:

```
translateModelFMU(className, version="2.0");
```

```
function translateModelFMU
  input TypeName className "the class that should translated";
  input String version = "2.0" "FMU version, 1.0 or 2.0.";
  input String fmuType = "me" "FMU type, me (model exchange), cs (co-simulation),
  ↪me_cs (both model exchange and co-simulation)";
  input String fileNamePrefix = "<default>" "fileNamePrefix. <default> = \
  ↪"className\"";
  input Boolean includeResources = false "include Modelica based resources via
  ↪loadResource or not";
  output String generatedFileName "Returns the full path of the generated FMU.";
end translateModelFMU;
```

24.1.355 typeNameString

```
function typeNameString
  input TypeName cl;
  output String out;
end typeNameString;
```

24.1.356 typeNameStrings

```
function typeNameStrings
  input TypeName cl;
  output String out[:];
end typeNameStrings;
```

24.1.357 typeOf

```
function typeOf
  input VariableName variableName;
  output String result;
end typeOf;
```

24.1.358 unloadOMSimulator

```
free the OMSimulator instances
```

```
function unloadOMSimulator
  output Integer status;
end unloadOMSimulator;
```

24.1.359 updateConnection

```
function updateConnection
  input TypeName className;
  input String from;
  input String to;
  input ExpressionOrModification annotate;
  output Boolean result;
end updateConnection;
```

24.1.360 updateConnectionAnnotation

```
function updateConnectionAnnotation
  input TypeName className;
  input String from;
  input String to;
  input String annotate;
  output Boolean result;
end updateConnectionAnnotation;
```

24.1.361 updateConnectionNames

```
function updateConnectionNames
  input TypeName className;
  input String from;
  input String to;
  input String fromNew;
  input String toNew;
  output Boolean result;
end updateConnectionNames;
```

24.1.362 updateInitialState

```
function updateInitialState
  input TypeName cl;
  input String state;
  input ExpressionOrModification annotate;
  output Boolean bool;
end updateInitialState;
```

24.1.363 updatePackageIndex

```
function updatePackageIndex
  output Boolean result;
end updatePackageIndex;
```

24.1.364 updateTransition

```
function updateTransition
  input TypeName cl;
  input String from;
  input String to;
  input String oldCondition;
  input Boolean oldImmediate;
  input Boolean oldReset;
  input Boolean oldSynchronize;
  input Integer oldPriority;
  input String newCondition;
  input Boolean newImmediate;
  input Boolean newReset;
  input Boolean newSynchronize;
  input Integer newPriority;
  input ExpressionOrModification annotate;
  output Boolean bool;
end updateTransition;
```

24.1.365 upgradeInstalledPackages

```
function upgradeInstalledPackages
  input Boolean installNewestVersions = true;
  output Boolean result;
end upgradeInstalledPackages;
```

24.1.366 uriToFilename

```
function uriToFilename
  input String uri;
  output String filename = "";
end uriToFilename;
```

24.1.367 val

Return the value of a variable at a given time **in** the simulation results

```
function val
  input VariableName var;
  input Real timePoint = 0.0;
  input String fileName = "<default>" "The contents of the currentSimulationResult_
↪variable";
  output Real valAtTime;
end val;
```

24.1.368 verifyCompiler

```
function verifyCompiler
  output Boolean compilerWorks;
end verifyCompiler;
```

24.1.369 writeFile

Write the data to file. Returns `true` on success.

```
impure function writeFile
  input String fileName;
  input String data;
  input Boolean append = false;
  output Boolean success;
end writeFile;
```

24.2 Simulation Parameter Sweep

Following example shows how to update the parameters and re-run the simulation without compiling the model.

```
loadFile("BouncingBall.mo");
getErrorString();
// build the model once
buildModel(BouncingBall);
getErrorString();
for i in 1:3 loop
  // We update the parameter e start value from 0.7 to "0.7 + i".
  value := 0.7 + i;
  // call the generated simulation code to produce a result file BouncingBall%i%_
  ↪res.mat
  system("./BouncingBall -override=e="+String(value)+" -r=BouncingBall" +
  ↪String(i) + "_res.mat");
  getErrorString();
end for;
```

We used the `BouncingBall.mo` in the example above. The above example produces three result files each containing different start value for e i.e., 1.7, 2.7, 3.7.

24.3 Examples

The following is an interactive session with the OpenModelica environment including some of the abovementioned commands and examples. First we start the system, and use the command line interface from OMSHELL, OMNotebook, or command window of some of the other tools.

We type in a very small model:

```
model Test "Testing OpenModelica Scripts"
  Real x, y;
equation
  x = 5.0+time; y = 6.0;
end Test;
```

We give the command to flatten a model:

```
>>> instantiateModel (Test)
class Test "Testing OpenModelica Scripts"
  Real x;
  Real y;
equation
  x = 5.0 + time;
  y = 6.0;
end Test;
```

A range expression is typed in:

```
>>> a:=1:10
{1,2,3,4,5,6,7,8,9,10}
```

It is multiplied by 2:

```
>>> a*2
{2,4,6,8,10,12,14,16,18,20}
```

The variables are cleared:

```
>>> clearVariables()
true
```

We print the loaded class test from its internal representation:

```
>>> list (Test)
model Test "Testing OpenModelica Scripts"
  Real x, y;
equation
  x = 5.0 + time;
  y = 6.0;
end Test;
```

We get the name and other properties of a class:

```
>>> getClassNames ()
{Test,ProfilingTest}
>>> getClassComment (Test)
"Testing OpenModelica Scripts"
>>> isPartial (Test)
false
>>> isPackage (Test)
false
>>> isModel (Test)
true
>>> checkModel (Test)
"Check of Test completed successfully.
Class Test has 2 equation(s) and 2 variable(s).
2 of these are trivial equation(s)."
```

The common combination of a simulation followed by getting a value and doing a plot:

```
>>> simulate (Test, stopTime=3.0)
record SimulationResult
  resultFile = "«DOCHOME»/Test_res.mat",
  simulationOptions = "startTime = 0.0, stopTime = 3.0, numberOfIntervals = 500,
↳tolerance = 1e-06, method = 'dassl', fileNamePrefix = 'Test', options = '',
↳outputFormat = 'mat', variableFilter = '.*', cflags = '', simflags = '',
  messages = "LOG_SUCCESS      | info      | The initialization finished
↳successfully without homotopy method.
LOG_SUCCESS      | info      | The simulation finished successfully."
```

(continues on next page)

(continued from previous page)

```

stdout          | info      | Time measurements are stored in Test_prof.html_
↔(human-readable) and Test_prof.xml (for XSL transforms or more details)
",
  timeFrontend = 0.009480666,
  timeBackend  = 0.001381974,
  timeSimCode  = 0.000425128,
  timeTemplates = 0.00299945,
  timeCompile  = 0.421490131,
  timeSimulation = 0.039303124,
  timeTotal    = 0.475182154
end SimulationResult;
>>> val(x , 2.0)
7.0

```

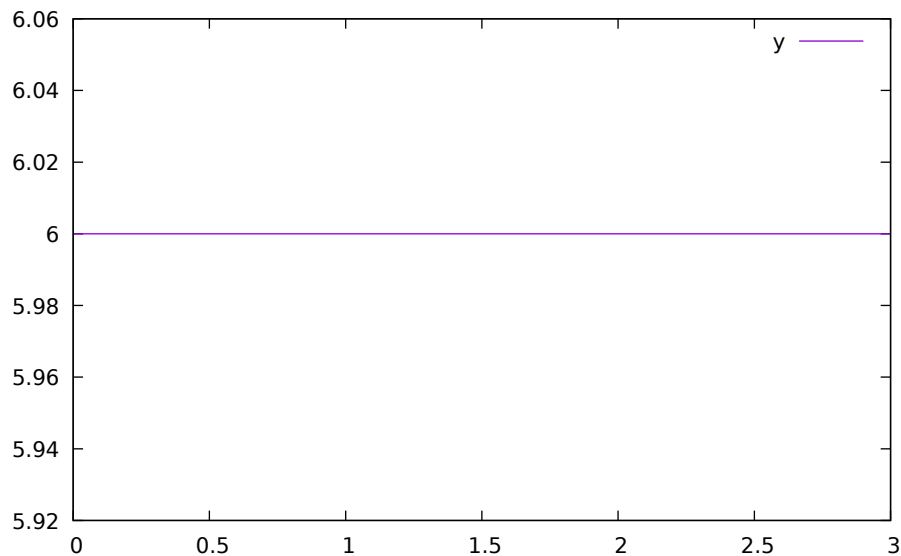

Figure 24.1: Plot generated by OpenModelica+gnuplot

```
>>> plotall()
```

24.3.1 Interactive Function Calls, Reading, and Writing

We enter an assignment of a vector expression, created by the range construction expression 1:12, to be stored in the variable x. The type and the value of the expression is returned.

```

>>> x := 1:12
{1, 2, 3, 4, 5, 6, 7, 8, 9, 10, 11, 12}

```

The function bubblesort is called to sort this vector in descending order. The sorted result is returned together with its type. Note that the result vector is of type Real[:], instantiated as Real[12], since this is the declared type of the function result. The input Integer vector was automatically converted to a Real vector according to the Modelica type coercion rules.

```

>>> loadFile(getInstallationDirectoryPath() + "/share/doc/omc/testmodels/
↔bubblesort.mo")
true
>>> bubblesort(x)
{12.0, 11.0, 10.0, 9.0, 8.0, 7.0, 6.0, 5.0, 4.0, 3.0, 2.0, 1.0}

```

Now we want to try another small application, a simplex algorithm for optimization. First read in a small matrix containing coefficients that define a simplex problem to be solved:

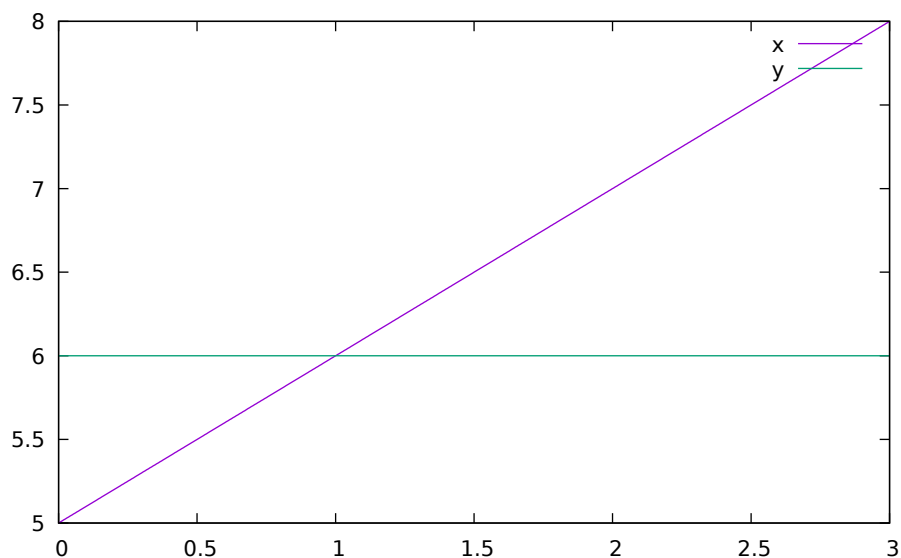

Figure 24.2: Plot generated by OpenModelica+gnuplot

```
>>> a := {
  {-1,-1,-1, 0, 0, 0, 0, 0, 0},
  {-1, 1, 0, 1, 0, 0, 0, 0, 5},
  { 1, 4, 0, 0, 1, 0, 0, 0, 45},
  { 2, 1, 0, 0, 0, 1, 0, 0, 27},
  { 3,-4, 0, 0, 0, 0, 1, 0, 24},
  { 0, 0, 1, 0, 0, 0, 0, 1, 4}
}
{{-1,-1,-1,0,0,0,0,0,0}, {-1,1,0,1,0,0,0,0,5}, {1,4,0,0,1,0,0,0,45}, {2,1,0,0,0,1,0,0,
↪27}, {3,-4,0,0,0,0,1,0,24}, {0,0,1,0,0,0,0,1,4}}
```

```
function pivot1
  input Real b[:, :];
  input Integer p;
  input Integer q;
  output Real a[size(b,1), size(b,2)];
```

```
protected
```

```
  Integer M;
```

```
  Integer N;
```

```
algorithm
```

```
  a := b;
```

```
  N := size(a,1)-1;
```

```
  M := size(a,2)-1;
```

```
  for j in 1:N loop
```

```
    for k in 1:M loop
```

```
      if j<>p and k<>q then
```

```
        a[j,k] := a[j,k]-0.3*j;
```

```
      end if;
```

```
    end for;
```

```
  end for;
```

```
  a[p,q] := 0.05;
```

```
end pivot1;
```

```
function misc_simplex1
```

```
  input Real matr[:, :];
```

```
  output Real x[size(matr,2)-1];
```

```
  output Real z;
```

```
  output Integer q;
```

(continues on next page)

(continued from previous page)

```

output Integer p;
protected
  Real a[size(matr,1),size(matr,2)];
  Integer M;
  Integer N;
algorithm
  N := size(a,1)-1;
  M := size(a,2)-1;
  a := matr;
  p:=0;q:=0;
  a := pivot1(a,p+1,q+1);
  while not (q==(M) or p==(N)) loop
    q := 0;
    while not (q == (M) or a[0+1,q+1]>1) loop
      q:=q+1;
    end while;
    p := 0;
    while not (p == (N) or a[p+1,q+1]>0.1) loop
      p:=p+1;
    end while;
    if (q < M) and (p < N) and(p>0) and (q>0) then
      a := pivot1(a,p,q);
    end if;
    if(p<=0) and (q<=0) then
      a := pivot1(a,p+1,q+1);
    end if;
    if(p<=0) and (q>0) then
      a := pivot1(a,p+1,q);
    end if;
    if(p>0) and (q<=0) then
      a := pivot1(a,p,q+1);
    end if;
  end while;
  z := a[1,M];
  x := {a[1,i] for i in 1:size(x,1)};
  for i in 1:10 loop
    for j in 1:M loop
      x[j] := x[j]+x[j]*0.01;
    end for;
  end for;
end misc_simplex1;

```

Then call the simplex algorithm implemented as the Modelica function `simplex1`. This function returns four results, which are represented as a tuple of four return values:

```

>>> misc_simplex1(a)
({0.05523110627056022,-1.104622125411205,-1.104622125411205,0.0,0.0,0.0,0.0,0.0},0.
↪0,8,1)

```

PACKAGE MANAGER

OpenModelica includes a package manager for installing Modelica packages. This chapter includes some details on how to install packages and how the package index itself works.

25.1 Installing packages

The following commands setup an empty library directory for generating this documentation. You probably want to use the default ModelicaPath.

```
>>> clear()
true
>>> system("rm -rf /tmp/omc-pkgman")
0
>>> setEnvironmentVar("HOME", "/tmp/omc-pkgman")
true
>>> setModelicaPath("/tmp/omc-pkgman/.openmodelica/libraries/")
true
```

If you do not manually update the package index, the index is downloaded when trying to install a package. Update the index when you want to get the latest versions of all Modelica packages.

```
>>> clear()
true
>>> updatePackageIndex()
true
"/tmp/omc-pkgman/.openmodelica/libraries/index.json:0:0-0:0:readonly]
↳Notification: Downloaded package index from URL https://libraries.openmodelica.
↳org/index/v1/index.json.
"
```

You can install a specific version of a package by using *exactMatch=true*. If a dependency does not have an exact match, another version will be installed. In this case, the dependencies are available.

```
>>> clear()
true
>>> installPackage(Buildings, "1.5.0+build.3", exactMatch=true)
true
"/tmp/omc-pkgman/.openmodelica/libraries/ModelicaServices 1.1.0/package.mo:0:0-
↳0:0:readonly] Notification: Package installed successfully (SHA
↳da986cae8f24d6cef27917e0b6f12871f03f84e0).
[/tmp/omc-pkgman/.openmodelica/libraries/Complex 1.1.0/package.mo:0:0-
↳0:0:readonly] Notification: Package installed successfully (SHA
↳da986cae8f24d6cef27917e0b6f12871f03f84e0).
[/tmp/omc-pkgman/.openmodelica/libraries/Modelica 3.2.0+maint.om/package.mo:0:0-
↳0:0:readonly] Notification: Package installed successfully (SHA
↳da986cae8f24d6cef27917e0b6f12871f03f84e0).
[/tmp/omc-pkgman/.openmodelica/libraries/Buildings 1.5.0+build.3/package.mo:0:0-
↳0:0:readonly] Notification: Package installed successfully (SHA
↳5734e67c306f0cfc46e7e1794da265e16bb22dfa).
```

(continues on next page)

(continued from previous page)

"

You can also specify that the most well-supported version of the package and its dependencies is installed. The dependencies installed in this case are the same as if the index did not contain the exact match in the previous example.

```
>>> clear()
true
>>> installPackage(Buildings, "1.5.0+build.3")
true
"/tmp/omc-pkgman/.openmodelica/libraries//Buildings 1.5.0+build.3:0:0-
↳0:0:readonly] Notification: Buildings 1.5.0+build.3 will not be installed since
↳version 1.5.0+build.3 is installed.
[/tmp/omc-pkgman/.openmodelica/libraries/ModelicaServices 3.2.3+maint.om/package.
↳mo:0:0-0:0:readonly] Notification: Package installed successfully (SHA
↳24a7b5e1f649ec4653445c1eb914282d79f48757).
[/tmp/omc-pkgman/.openmodelica/libraries/Complex 3.2.3+maint.om/package.mo:0:0-
↳0:0:readonly] Notification: Package installed successfully (SHA
↳24a7b5e1f649ec4653445c1eb914282d79f48757).
[/tmp/omc-pkgman/.openmodelica/libraries/Modelica 3.2.3+maint.om/package.mo:0:0-
↳0:0:readonly] Notification: Package installed successfully (SHA
↳24a7b5e1f649ec4653445c1eb914282d79f48757).
"
```

Show that the correct version is now loaded.

```
>>> loadModel(Buildings)
true
"/tmp/omc-pkgman/.openmodelica/libraries/Modelica 3.2.0+maint.om/Fluid/
↳Dissipation.mo:8490:35-8490:107:writable] Warning: The file was not encoded in
↳UTF-8:
  \" <html> <p> Calculation of a generic pressure loss in dependence of nom...\".
  Defaulting to 7-bit ASCII with unknown characters replaced by '?'.
  To change encoding when loading a file: loadFile(encoding=\"ISO-XXXX-YY\").
  To change it in a package: add a file package.encoding at the top-level.
  Note: The Modelica Language Specification only allows files encoded in UTF-8.
[/tmp/omc-pkgman/.openmodelica/libraries/Modelica 3.2.0+maint.om/Fluid/Dissipation.
↳mo:8600:35-8600:107:writable] Warning: The file was not encoded in UTF-8:
  \" <html> <p> Calculation of a generic pressure loss in dependence of nomi...\".
  Defaulting to 7-bit ASCII with unknown characters replaced by '?'.
  To change encoding when loading a file: loadFile(encoding=\"ISO-XXXX-YY\").
  To change it in a package: add a file package.encoding at the top-level.
  Note: The Modelica Language Specification only allows files encoded in UTF-8.
[/tmp/omc-pkgman/.openmodelica/libraries/Modelica 3.2.0+maint.om/Fluid/Dissipation.
↳mo:8738:35-8738:107:writable] Warning: The file was not encoded in UTF-8:
  \" <html> <p> Calculation of a generic pressure loss in dependence of a pr...\".
  Defaulting to 7-bit ASCII with unknown characters replaced by '?'.
  To change encoding when loading a file: loadFile(encoding=\"ISO-XXXX-YY\").
  To change it in a package: add a file package.encoding at the top-level.
  Note: The Modelica Language Specification only allows files encoded in UTF-8.
[/tmp/omc-pkgman/.openmodelica/libraries/Modelica 3.2.0+maint.om/Fluid/Dissipation.
↳mo:8793:35-8793:107:writable] Warning: The file was not encoded in UTF-8:
  \" <html> <p> Calculation of a generic pressure loss with linear or quadra...\".
  Defaulting to 7-bit ASCII with unknown characters replaced by '?'.
  To change encoding when loading a file: loadFile(encoding=\"ISO-XXXX-YY\").
  To change it in a package: add a file package.encoding at the top-level.
  Note: The Modelica Language Specification only allows files encoded in UTF-8.
[/tmp/omc-pkgman/.openmodelica/libraries/Modelica 3.2.0+maint.om/Math/Nonlinear.
↳mo:570:14-570:31:writable] Warning: Treating .0158271919734802 as 0.
↳0158271919734802. This is not standard Modelica and only done for compatibility
↳with old code. Support for this feature may be removed in the future.
```

(continues on next page)

(continued from previous page)

```

[/tmp/omc-pkgman/.openmodelica/libraries/Modelica 3.2.0+maint.om/Math/Nonlinear.
↳mo:570:48-570:65:writable] Warning: Treating .0942738402188500 as 0.
↳0942738402188500. This is not standard Modelica and only done for compatibility
↳with old code. Support for this feature may be removed in the future.
[/tmp/omc-pkgman/.openmodelica/libraries/Modelica 3.2.0+maint.om/Math/Nonlinear.
↳mo:571:13-571:29:writable] Warning: Treating .155071987336585 as 0.
↳155071987336585. This is not standard Modelica and only done for compatibility
↳with old code. Support for this feature may be removed in the future.
[/tmp/omc-pkgman/.openmodelica/libraries/Modelica 3.2.0+maint.om/Math/Nonlinear.
↳mo:571:47-571:63:writable] Warning: Treating .188821573960182 as 0.
↳188821573960182. This is not standard Modelica and only done for compatibility
↳with old code. Support for this feature may be removed in the future.
[/tmp/omc-pkgman/.openmodelica/libraries/Modelica 3.2.0+maint.om/Math/Nonlinear.
↳mo:572:9-572:25:writable] Warning: Treating .199773405226859 as 0.
↳199773405226859. This is not standard Modelica and only done for compatibility
↳with old code. Support for this feature may be removed in the future.
[/tmp/omc-pkgman/.openmodelica/libraries/Modelica 3.2.0+maint.om/Math/Nonlinear.
↳mo:572:42-572:58:writable] Warning: Treating .224926465333340 as 0.
↳224926465333340. This is not standard Modelica and only done for compatibility
↳with old code. Support for this feature may be removed in the future.
[/tmp/omc-pkgman/.openmodelica/libraries/Modelica 3.2.0+maint.om/Math/Nonlinear.
↳mo:572:75-572:91:writable] Warning: Treating .242611071901408 as 0.
↳242611071901408. This is not standard Modelica and only done for compatibility
↳with old code. Support for this feature may be removed in the future.
"
>>> getVersion(Buildings)
"1.5"

```

You can also make sure you have the latest versions of all installed packages:

```

>>> clear()
true
>>> upgradeInstalledPackages(installNewestVersions=true)
true
"/tmp/omc-pkgman/.openmodelica/libraries//Buildings 1.5.0+build.3:0:0-
↳0:0:readonly] Notification: Buildings 1.5.0+build.3 will not be installed since
↳version 1.5.0+build.3 is installed.
[/tmp/omc-pkgman/.openmodelica/libraries/Buildings 7.0.0/package.mo:0:0-
↳0:0:readonly] Notification: Package installed successfully (SHA
↳903a06999fb514ebc1d0f58ef41b3f6dda0279ed).
[/tmp/omc-pkgman/.openmodelica/libraries//Complex 1.1.0:0:0-0:0:readonly]
↳Notification: Complex 1.1.0 will not be installed since version 1.1.0 is
↳installed.
[/tmp/omc-pkgman/.openmodelica/libraries//Complex 3.2.3+maint.om:0:0-0:0:readonly]
↳Notification: Complex 3.2.3+maint.om will not be installed since version 3.2.
↳3+maint.om is installed.
[/tmp/omc-pkgman/.openmodelica/libraries//Complex 3.2.3+maint.om:0:0-0:0:readonly]
↳Notification: Complex will not be installed since version 3.2.3+maint.om is
↳installed.
[/tmp/omc-pkgman/.openmodelica/libraries//Modelica 3.2.0+maint.om:0:0-
↳0:0:readonly] Notification: Modelica 3.2.0+maint.om will not be installed since
↳version 3.2.0+maint.om is installed.
[/tmp/omc-pkgman/.openmodelica/libraries//Modelica 3.2.3+maint.om:0:0-
↳0:0:readonly] Notification: Modelica 3.2.3+maint.om will not be installed since
↳version 3.2.3+maint.om is installed.
[/tmp/omc-pkgman/.openmodelica/libraries//Modelica 3.2.3+maint.om:0:0-
↳0:0:readonly] Notification: Modelica will not be installed since version 3.2.
↳3+maint.om is installed.
[/tmp/omc-pkgman/.openmodelica/libraries//ModelicaServices 1.1.0:0:0-0:0:readonly]
↳Notification: ModelicaServices 1.1.0 will not be installed since version 1.1.0
↳is installed.

```

(continues on next page)

(continued from previous page)

```
[/tmp/omc-pkgman/.openmodelica/libraries//ModelicaServices 3.2.3+maint.om:0:0-  
↔0:0:readonly] Notification: ModelicaServices 3.2.3+maint.om will not be_  
↔installed since version 3.2.3+maint.om is installed.  
[/tmp/omc-pkgman/.openmodelica/libraries//ModelicaServices 3.2.3+maint.om:0:0-  
↔0:0:readonly] Notification: ModelicaServices will not be installed since_  
↔version 3.2.3+maint.om is installed.  
"
```

```
>>> setModelicaPath(OpenModelica.Scripting.getInstallationDirectoryPath()+"/lib/  
↔omlibrary")  
true
```

25.2 How the package index works

The package index is generated by [OMPpackageManager](#) on a server. See its documentation to see how to add new packages to the index, change support level, and so on.

The index is generated by scanning git repositories on github. All tags and optionally some specific branches are scanned. The tag name is parsed as if it was a semantic version, with prerelease and metadata of the tag added to the version of Modelica packages in the repository. If the tag name is not a semantic version, it is sorted differently.

Packages are sorted as follows:

- Support level: each package is given a level of support in the index
- Semantic version: according to the semver specification, but build metadata is also considered (sorted the same way as pre-releases)
- Non-semantic versions: alphabetically

Packages that are candidates to install:

- Packages with the same version annotation as the desired version (ignoring pre-release and metadata information)
- Packages listed using a `noneFromVersion` annotation:

```
conversion(noneFromVersion = "3.2.1")
```

- Packages with a conversion script are not considered (because OpenModelica does not yet support them)

OPENMODELICA COMPILER FLAGS

Usage: omc [Options] (Model.mo | Script.mos) [Libraries | .mo-files]

- Libraries: Fully qualified names of libraries to load before processing Model or Script. The libraries should be separated by spaces: Lib1 Lib2 ... LibN.

26.1 Options

-d, --debug

Sets debug flags. Use *--help=debug* to see available flags.

String list (default *empty*).

-h, --help

Displays the help text. Use *--help=topics* for more information.

String (default *empty*).

--v, --version

Print the version and exit.

Boolean (default *false*).

--target

Sets the target compiler to use.

String (default *gcc*). Valid options:

- *gcc*
- *msvc*
- *msvc10*
- *msvc12*
- *msvc13*
- *msvc15*
- *msvc19*
- *vxworks69*
- *debugrt*

-g, --grammar

Sets the grammar and semantics to accept.

String (default *Modelica*). Valid options:

- *Modelica*
- *MetaModelica*
- *ParModelica*

- Optimica
- PDEModelica

--annotationVersion

Sets the annotation version that should be used.

String (default 3.x). Valid options:

- 1.x
- 2.x
- 3.x

--std

Sets the language standard that should be used.

String (default latest). Valid options:

- 1.x
- 2.x
- 3.1
- 3.2
- 3.3
- 3.4
- latest
- 3.5
- experimental

--showErrorMessages

Show error messages immediately when they happen.

Boolean (default `false`).

--showAnnotations

Show annotations in the flattened code.

Boolean (default `false`).

--noSimplify

Do not simplify expressions if set.

Boolean (default `false`).

--preOptModules

Sets the pre optimization modules to use in the back end. See *--help=optmodules* for more info.

String list (default `normalInlineFunction,evaluateParameters,simplifyIfEquations,expandDerOperator,clockPartitioning,findStateOr`

Valid options:

- `introduceOutputAliases` (Introduces aliases for top-level outputs.)
- `clockPartitioning` (Does the clock partitioning.)
- `collapseArrayExpressions` (Simplifies $\{x[1],x[2],x[3]\} \rightarrow x$ for arrays of whole variable references (simplifies code generation).)
- `comSubExp` (Introduces alias assignments for variables which are assigned to simple terms i.e. $a = b/c$; $d = b/c$; $--> a=d$)
- `dumpDAE` (dumps the DAE representation of the current transformation state)
- `dumpDAEXML` (dumps the DAE as xml representation of the current transformation state)
- `encapsulateWhenConditions` (This module replaces each when condition with a boolean variable.)

- `evalFunc` (evaluates functions partially)
- `evaluateParameters` (Evaluates parameters with annotation `Evaluate=true`). Use `'--evaluateFinalParameters=true'` or `'--evaluateProtectedParameters=true'` to specify additional parameters to be evaluated. Use `'--replaceEvaluatedParameters=true'` if the evaluated parameters should be replaced in the DAE. To evaluate all parameters in the Frontend use `-d=evaluateAllParameters`.)
- `expandDerOperator` (Expands `der(expr)` using `Derive.differentiateExpTime`.)
- `findStateOrder` (Sets derivative information to states.)
- `inlineArrayEqn` (This module expands all array equations to scalar equations.)
- `normalInlineFunction` (Perform function inlining for function with annotation `Inline=true`.)
- `inputDerivativesForDynOpt` (Allowed derivatives of inputs in dyn. optimization.)
- `introduceDerAlias` (Adds for every `der`-call an alias equation e.g. $dx = \text{der}(x)$.)
- `removeEqualRHS` (Detects equal expressions of the form $a = \langle \text{exp} \rangle$ and $b = \langle \text{exp} \rangle$ and substitutes them to get speed up.)
- `removeProtectedParameters` (Replace all parameters with `protected=true` in the system.)
- `removeSimpleEquations` (Performs alias elimination and removes constant variables from the DAE, replacing all occurrences of the old variable reference with the new value (constants) or variable reference (alias elimination).)
- `removeUnusedParameter` (Strips all parameter not present in the equations from the system.)
- `removeUnusedVariables` (Strips all variables not present in the equations from the system.)
- `removeVerySimpleEquations` ([Experimental] Like `removeSimpleEquations`, but less thorough. Note that this always uses the experimental new alias elimination, `--removeSimpleEquations=new`, which makes it unstable. In particular, MultiBody systems fail to translate correctly. It can be used for simple (but large) systems of equations.)
- `replaceEdgeChange` (Replace $\text{edge}(b) = b$ and $\text{not pre}(b)$ and $\text{change}(b) = v \Leftrightarrow \text{pre}(v)$.)
- `residualForm` (Transforms simple equations $x=y$ to zero-sum equations $0=y-x$.)
- `resolveLoops` (resolves linear equations in loops)
- `simplifyAllExpressions` (Does simplifications on all expressions.)
- `simplifyIfEquations` (Tries to simplify if equations by use of information from evaluated parameters.)
- `sortEqnsVars` (Heuristic sorting for equations and variables.)
- `unitChecking` (Does advanced unit checking which consists of two parts: 1. calculation of unspecified unit information for variables; 2. consistency check for all equations based on unit information. Please note: This module is still experimental.)
- `wrapFunctionCalls` (This module introduces variables for each function call and substitutes all these calls with the newly introduced variables.)

--cheapmatchingAlgorithm

Sets the cheap matching algorithm to use. A cheap matching algorithm gives a jump start matching by heuristics.

Integer (default 3). Valid options:

- 0 (No cheap matching.)
- 1 (Cheap matching, traverses all equations and match the first free variable.)
- 3 (Random Karp-Sipser: R. M. Karp and M. Sipser. Maximum matching in sparse random graphs.)

--matchingAlgorithm

Sets the matching algorithm to use. See *--help=optmodules* for more info.

String (default PFPlusExt). Valid options:

- BFSB (Breadth First Search based algorithm.)
- DFSB (Depth First Search based algorithm.)

- MC21A (Depth First Search based algorithm with look ahead feature.)
- PF (Depth First Search based algorithm with look ahead feature.)
- PFPlus (Depth First Search based algorithm with look ahead feature and fair row traversal.)
- HK (Combined BFS and DFS algorithm.)
- HKDW (Combined BFS and DFS algorithm.)
- ABMP (Combined BFS and DFS algorithm.)
- PR (Matching algorithm using push relabel mechanism.)
- DFSBExt (Depth First Search based Algorithm external c implementation.)
- BFSBExt (Breadth First Search based Algorithm external c implementation.)
- MC21AExt (Depth First Search based Algorithm with look ahead feature external c implementation.)
- PFExt (Depth First Search based Algorithm with look ahead feature external c implementation.)
- PFPlusExt (Depth First Search based Algorithm with look ahead feature and fair row traversal external c implementation.)
- HKExt (Combined BFS and DFS algorithm external c implementation.)
- HKDWExt (Combined BFS and DFS algorithm external c implementation.)
- ABMPExt (Combined BFS and DFS algorithm external c implementation.)
- PREExt (Matching algorithm using push relabel mechanism external c implementation.)
- BB (BBs try.)

--indexReductionMethod

Sets the index reduction method to use. See *--help=optmodules* for more info.

String (default `dynamicStateSelection`). Valid options:

- none (Skip index reduction)
- uode (Use the underlying ODE without the constraints.)
- dynamicStateSelection (Simple index reduction method, select (dynamic) dummy states based on analysis of the system.)
- dummyDerivatives (Simple index reduction method, select (static) dummy states based on heuristic.)

--postOptModules

Sets the post optimization modules to use in the back end. See *--help=optmodules* for more info.

String list (default `lateInlineFunction,wrapFunctionCalls,inlineArrayEqn,constantLinearSystem,simplifysemiLinear,removeSimpleF`)

Valid options:

- addScaledVars_states (added `var_norm = var/nominal`, where `var` is state)
- addScaledVars_inputs (added `var_norm = var/nominal`, where `var` is input)
- addTimeAsState (Experimental feature: this replaces each occurrence of variable time with a new introduced state `$time` with equation `der($time) = 1.0`)
- calculateStateSetsJacobians (Generates analytical jacobian for dynamic state selection sets.)
- calculateStrongComponentJacobians (Generates analytical jacobian for torn linear and non-linear strong components. By default linear components and non-linear components with user-defined function calls are skipped. See also debug flags: `LSanalyticJacobian`, `NLSanalyticJacobian` and `forceNLSanalyticJacobian`)
- collapseArrayExpressions (Simplifies `{x[1],x[2],x[3]}` → `x` for arrays of whole variable references (simplifies code generation).)
- constantLinearSystem (Evaluates constant linear systems ($a*x+b*y=c$; $d*x+e*y=f$; a,b,c,d,e,f are constants) at compile-time.)
- countOperations (Count the mathematical operations of the system.)

- cseBinary (Common Sub-expression Elimination)
- dumpComponentsGraphStr (Dumps the assignment graph used to determine strong components to format suitable for Mathematica)
- dumpDAE (dumps the DAE representation of the current transformation state)
- dumpDAEXML (dumps the DAE as xml representation of the current transformation state)
- evaluateParameters (Evaluates parameters with annotation(Evaluate=true). Use '--evaluateFinalParameters=true' or '--evaluateProtectedParameters=true' to specify additional parameters to be evaluated. Use '--replaceEvaluatedParameters=true' if the evaluated parameters should be replaced in the DAE. To evaluate all parameters in the Frontend use -d=evaluateAllParameters.)
- extendDynamicOptimization (Move loops to constraints.)
- generateSymbolicLinearization (Generates symbolic linearization matrices A,B,C,D for linear model: $\dot{x} = Ax + Bu$)
- generateSymbolicSensitivities (Generates symbolic Sensivities matrix, where der(x) is differentiated w.r.t. param.)
- inlineArrayEqn (This module expands all array equations to scalar equations.)
- inputDerivativesUsed (Checks if derivatives of inputs are need to calculate the model.)
- lateInlineFunction (Perform function inlining for function with annotation LateInline=true.)
- partIntornsystem (partitions linear torn systems.)
- recursiveTearing (inline and repeat tearing)
- reduceDynamicOptimization (Removes equations which are not needed for the calculations of cost and constraints. This module requires -d=reduceDynOpt.)
- relaxSystem (relaxation from gaussian elimination)
- removeConstants (Remove all constants in the system.)
- removeEqualRHS (Detects equal function calls of the form a=f(b) and c=f(b) and substitutes them to get speed up.)
- removeSimpleEquations (Performs alias elimination and removes constant variables from the DAE, replacing all occurrences of the old variable reference with the new value (constants) or variable reference (alias elimination).)
- removeUnusedParameter (Strips all parameter not present in the equations from the system to get speed up for compilation of target code.)
- removeUnusedVariables (Strips all variables not present in the equations from the system to get speed up for compilation of target code.)
- reshufflePost (Reshuffles algebraic loops.)
- simplifyAllExpressions (Does simplifications on all expressions.)
- simplifyComplexFunction (Some simplifications on complex functions (complex refers to the internal data structure))
- simplifyConstraints (Rewrites nonlinear constraints into box constraints if possible. This module requires +gDynOpt.)
- simplifyLoops (Simplifies algebraic loops. This modules requires +simplifyLoops.)
- simplifyTimeIndepFuncCalls (Simplifies time independent built in function calls like pre(param) -> param, der(param) -> 0.0, change(param) -> false, edge(param) -> false.)
- simplifysemiLinear (Simplifies calls to semiLinear.)
- solveLinearSystem (solve linear system with newton step)
- solveSimpleEquations (Solves simple equations)
- symSolver (Rewrites the ode system for implicit Euler method. This module requires +symSolver.)

- `symbolicJacobian` (Detects the sparse pattern of the ODE system and calculates also the symbolic Jacobian if flag `--generateSymbolicJacobian` is enabled.)
- `tearingSystem` (For method selection use flag `tearingMethod`.)
- `wrapFunctionCalls` (This module introduces variables for each function call and substitutes all these calls with the newly introduced variables.)

--simCodeTarget

Sets the target language for the code generation.

String (default C). Valid options:

- None
- Adevs
- C
- Cpp
- omsicpp
- CSharp
- ExperimentalEmbeddedC
- Java
- JavaScript
- omsic
- sfmi
- XML
- MidC

--orderConnections

Orders connect equations alphabetically if set.

Boolean (default `true`).

-t, --typeinfo

Prints out extra type information if set.

Boolean (default `false`).

-a, --keepArrays

Sets whether to split arrays or not.

Boolean (default `false`).

-m, --modelicaOutput

Enables valid modelica output for flat modelica.

Boolean (default `false`).

-q, --silent

Turns on silent mode.

Boolean (default `false`).

-c, --corbaSessionName

Sets the name of the corba session if `-d=interactiveCorba` or `--interactive=corba` is used.

String (default `empty`).

-n, --numProcs

Sets the number of processors to use (0=default=auto).

Integer (default 0).

-l, --latency

Sets the latency for parallel execution.

Integer (default 0).

-b, --bandwidth

Sets the bandwidth for parallel execution.

Integer (default 0).

-i, --instClass

Instantiate the class given by the fully qualified path.

String (default *empty*).

-v, --vectorizationLimit

Sets the vectorization limit, arrays and matrices larger than this will not be vectorized.

Integer (default 0).

-s, --simulationCg

Turns on simulation code generation.

Boolean (default *false*).

--evalAnnotationParams

Sets whether to evaluate parameters in annotations or not.

Boolean (default *false*).

--generateLabeledSimCode

Turns on labeled SimCode generation for reduction algorithms.

Boolean (default *false*).

--reduceTerms

Turns on reducing terms for reduction algorithms.

Boolean (default *false*).

--reductionMethod

Sets the reduction method to be used.

String (default *deletion*). Valid options:

- *deletion*
- *substitution*
- *linearization*

--demoMode

Disable Warning/Error Messages.

Boolean (default *false*).

--locale

Override the locale from the environment.

String (default *empty*).

-o, --defaultOCLDevice

Sets the default OpenCL device to be used for parallel execution.

Integer (default 0).

--maxTraversals

Maximal traversals to find simple equations in the acausal system.

Integer (default 2).

--dumpTarget

Redirect the dump to file. If the file ends with .html HTML code is generated.

String (default *empty*).

--delayBreakLoop

Enables (very) experimental code to break algebraic loops using the `delay()` operator. Probably messes with initialization.

Boolean (default `true`).

--tearingMethod

Sets the tearing method to use. Select no tearing or choose tearing method.

String (default `cellier`). Valid options:

- `noTearing` (Skip tearing. This breaks models with mixed continuous-integer/boolean unknowns)
- `minimalTearing` (Minimal tearing method to only tear discrete variables.)
- `omcTearing` (Tearing method developed by TU Dresden: Frenkel, Schubert.)
- `cellier` (Tearing based on Celliers method, revised by FH Bielefeld: Täuber, Patrick)

--tearingHeuristic

Sets the tearing heuristic to use for Cellier-tearing.

String (default `MC3`). Valid options:

- `MC1` (Original cellier with consideration of impossible assignments and discrete Vars.)
- `MC2` (Modified cellier, drop first step.)
- `MC11` (Modified MC1, new last step 'count impossible assignments'.)
- `MC21` (Modified MC2, new last step 'count impossible assignments'.)
- `MC12` (Modified MC1, step 'count impossible assignments' before last step.)
- `MC22` (Modified MC2, step 'count impossible assignments' before last step.)
- `MC13` (Modified MC1, build sum of impossible assignment and causalizable equations, choose var with biggest sum.)
- `MC23` (Modified MC2, build sum of impossible assignment and causalizable equations, choose var with biggest sum.)
- `MC231` (Modified MC23, Two rounds, choose better potentials-set.)
- `MC3` (Modified cellier, build sum of impossible assignment and causalizable equations for all vars, choose var with biggest sum.)
- `MC4` (Modified cellier, use all heuristics, choose var that occurs most in potential sets)

--disableLinearTearing

Disables the tearing of linear systems. That might improve the performance of large linear systems ($N > 1000$) in combination with a sparse solver (e.g. `umfpack`) at runtime (usage with: `-ls umfpack`). Deprecated flag: Use `--maxSizeLinearTearing=0` instead.

Boolean (default `false`).

--scalarizeMinMax

Scalarizes the builtin min/max reduction operators if true.

Boolean (default `false`).

--strict

Enables stricter enforcement of Modelica language rules.

Boolean (default `false`).

--scalarizeBindings

Always scalarizes bindings if set.

Boolean (default `false`).

--corbaObjectReferenceFilePath

Sets the path for corba object reference file if `-d=interactiveCorba` is used.

String (default `empty`).

--hpcScheduler

Sets the scheduler for task graph scheduling (`list` | `listr` | `level` | `levelfix` | `ext` | `metis` | `mcp` | `taskdep` | `tds` | `bls` | `rand` | `none`). Default: `level`.

String (default `level`).

--hpcCode

Sets the code-type produced by hpc (openmp | pthreads | pthreads_spin | tbb | mpi). Default: `openmp`.

String (default `openmp`).

--rewriteRulesFile

Activates user given rewrite rules for Absyn expressions. The rules are read from the given file and are of the form `rewrite(fromExp, toExp);`

String (default `empty`).

--replaceHomotopy

Replaces homotopy(actual, simplified) with the actual expression or the simplified expression. Good for debugging models which use homotopy. The default is to not replace homotopy.

String (default `none`). Valid options:

- none (Default, do not replace homotopy.)
- actual (Replace homotopy(actual, simplified) with actual.)
- simplified (Replace homotopy(actual, simplified) with simplified.)

--generateSymbolicJacobian

Generates symbolic Jacobian matrix, where $\text{der}(x)$ is differentiated w.r.t. x . This matrix can be used by `dassl` or `ida` solver with simulation flag `'-jacobian'`.

Boolean (default `false`).

--generateSymbolicLinearization

Generates symbolic linearization matrices A,B,C,D for linear model: $\dot{x} = Ax + Bu$ $y = Cx + Du$

Boolean (default `false`).

--intEnumConversion

Allow Integer to enumeration conversion.

Boolean (default `false`).

--profiling

Sets the profiling level to use. Profiled equations and functions record execution time and count for each time step taken by the integrator.

String (default `none`). Valid options:

- none (Generate code without profiling)
- blocks (Generate code for profiling function calls as well as linear and non-linear systems of equations)
- blocks+html (Like blocks, but also run `xsltproc` and `gnuplot` to generate an html report)
- all (Generate code for profiling of all functions and equations)

- `all_perf` (Generate code for profiling of all functions and equations with additional performance data using the papi-interface (cpp-runtime))
- `all_stat` (Generate code for profiling of all functions and equations with additional statistics (cpp-runtime))

--reshuffle

sets tolerance of reshuffling algorithm: 1: conservative, 2: more tolerant, 3 resolve all

Integer (default 1).

--gDynOpt

Generate dynamic optimization problem based on annotation approach.

Boolean (default `false`).

--maxSizeSolveLinearSystem

Max size for solveLinearSystem.

Integer (default 0).

--cppFlags

Sets extra flags for compilation with the C++ compiler (e.g. `+cppFlags=-O3,-Wall`)

String list (default).

--removeSimpleEquations

Specifies method that removes simple equations.

String (default default). Valid options:

- `none` (Disables module)
- `default` (Performs alias elimination and removes constant variables. Default case uses in `preOpt` phase the `fastAcausal` and in `postOpt` phase the causal implementation.)
- `causal` (Performs alias elimination and removes constant variables. Causal implementation.)
- `fastAcausal` (Performs alias elimination and removes constant variables. `fastImplementation fastAcausal`.)
- `allAcausal` (Performs alias elimination and removes constant variables. Implementation `allAcausal`.)
- `new` (New implementation (experimental))

--dynamicTearing

Activates dynamic tearing (TearingSet can be changed automatically during runtime, strict set vs. casual set.)

String (default false). Valid options:

- `false` (No dynamic tearing.)
- `true` (Dynamic tearing for linear and nonlinear systems.)
- `linear` (Dynamic tearing only for linear systems.)
- `nonlinear` (Dynamic tearing only for nonlinear systems.)

--symSolver

Activates symbolic implicit solver (original system is not changed).

String (default none). Valid options:

- `none`
- `impEuler`
- `expEuler`

--loop2con

Specifies method that transform loops in constraints. hint: using initial guess from file!

String (default none). Valid options:

- `none` (Disables module)

- `lin` (linear loops --> constraints)
- `noLin` (no linear loops --> constraints)
- `all` (loops --> constraints)

--forceTearing

Use tearing set even if it is not smaller than the original component.

Boolean (default `false`).

--simplifyLoops

Simplify algebraic loops.

Integer (default 0). Valid options:

- 0 (do nothing)
- 1 (special modification of residual expressions)
- 2 (special modification of residual expressions with helper variables)

--recursiveTearing

Inline and repeat tearing.

Integer (default 0). Valid options:

- 0 (do nothing)
- 1 (linear tearing set of size 1)
- 2 (linear tearing)

--flowThreshold

Sets the minimum threshold for stream flow rates

Real (default $1e-07$).

--matrixFormat

Sets the matrix format type in cpp runtime which should be used (`dense` | `sparse`). Default: `dense`.

String (default `dense`).

--partIntorn

Sets the limit for partitioning of linear torn systems.

Integer (default 0).

--initOptModules

Sets the initialization optimization modules to use in the back end. See *--help=optmodules* for more info.

String list (default `simplifyComplexFunction,tearingSystem,solveSimpleEquations,calculateStrongComponentJacobians,simplifyA`

Valid options:

- `calculateStrongComponentJacobians` (Generates analytical jacobian for torn linear and non-linear strong components. By default linear components and non-linear components with user-defined function calls are skipped. See also debug flags: `LSanalyticJacobian`, `NLSanalyticJacobian` and `forceNLSanalyticJacobian`)
- `collapseArrayExpressions` (Simplifies `{x[1],x[2],x[3]}` → `x` for arrays of whole variable references (simplifies code generation).)
- `constantLinearSystem` (Evaluates constant linear systems ($a*x+b*y=c$; $d*x+e*y=f$; a,b,c,d,e,f are constants) at compile-time.)
- `extendDynamicOptimization` (Move loops to constraints.)
- `generateHomotopyComponents` (Finds the parts of the DAE that have to be handled by the homotopy solver and creates a strong component out of it.)
- `inlineHomotopy` (Experimental: Inlines the homotopy expression to allow symbolic simplifications.)
- `inputDerivativesUsed` (Checks if derivatives of inputs are needed to calculate the model.)

- recursiveTearing (inline and repeat tearing)
- reduceDynamicOptimization (Removes equations which are not needed for the calculations of cost and constraints. This module requires `-d=reduceDynOpt.`)
- replaceHomotopyWithSimplified (Replaces the homotopy expression `homotopy(actual, simplified)` with the simplified part.)
- simplifyAllExpressions (Does simplifications on all expressions.)
- simplifyComplexFunction (Some simplifications on complex functions (complex refers to the internal data structure))
- simplifyConstraints (Rewrites nonlinear constraints into box constraints if possible. This module requires `+gDynOpt.`)
- simplifyLoops (Simplifies algebraic loops. This modules requires `+simplifyLoops.`)
- solveSimpleEquations (Solves simple equations)
- tearingSystem (For method selection use flag `tearingMethod.`)
- wrapFunctionCalls (This module introduces variables for each function call and substitutes all these calls with the newly introduced variables.)

--maxMixedDeterminedIndex

Sets the maximum mixed-determined index that is handled by the initialization.

Integer (default 10).

--useLocalDirection

Keeps the input/output prefix for all variables in the flat model, not only top-level ones.

Boolean (default `false`).

--defaultOptModulesOrdering

If this is activated, then the specified pre-/post-/init-optimization modules will be rearranged to the recommended ordering.

Boolean (default `true`).

--preOptModules+

Enables additional pre-optimization modules, e.g. `--preOptModules+=module1,module2` would additionally enable module1 and module2. See *--help=optmodules* for more info.

String list (default *empty*).

--preOptModules-

Disables a list of pre-optimization modules, e.g. `--preOptModules-=module1,module2` would disable module1 and module2. See *--help=optmodules* for more info.

String list (default *empty*).

--postOptModules+

Enables additional post-optimization modules, e.g. `--postOptModules+=module1,module2` would additionally enable module1 and module2. See *--help=optmodules* for more info.

String list (default *empty*).

--postOptModules-

Disables a list of post-optimization modules, e.g. `--postOptModules-=module1,module2` would disable module1 and module2. See *--help=optmodules* for more info.

String list (default *empty*).

--initOptModules+

Enables additional init-optimization modules, e.g. `--initOptModules+=module1,module2` would additionally enable module1 and module2. See *--help=optmodules* for more info.

String list (default *empty*).

--initOptModules-

Disables a list of init-optimization modules, e.g. `--initOptModules=module1,module2` would disable module1 and module2. See *--help=optmodules* for more info.

String list (default *empty*).

--instCacheSize

Sets the size of the internal hash table used for instantiation caching.

Integer (default 25343).

--maxSizeLinearTearing

Sets the maximum system size for tearing of linear systems (default 200).

Integer (default 200).

--maxSizeNonlinearTearing

Sets the maximum system size for tearing of nonlinear systems (default 10000).

Integer (default 10000).

--noTearingForComponent

Deactivates tearing for the specified components. Use `'-d=tearingdump'` to find out the relevant indexes.

Unknown default valueFlags.FlagData.INT_LIST_FLAG(data = {NIL})

--daeMode

Generates code to simulate models in DAE mode. The whole system is passed directly to the DAE solver SUN-DIALS/IDA and no algebraic solver is involved in the simulation process.

Boolean (default *false*).

--inlineMethod

Sets the inline method to use. `replace` : This method inlines by replacing in place all expressions. Might lead to very long expression. `append` : This method inlines by adding additional variables to the whole system. Might lead to much bigger system.

String (default `replace`). Valid options:

- `replace`
- `append`

--setTearingVars

Sets the tearing variables by its strong component indexes. Use `'-d=tearingdump'` to find out the relevant indexes. Use following format: `'--setTearingVars=(sci,n,t1,...,tn)*'`, with `sci` = strong component index, `n` = number of tearing variables, `t1,...,tn` = tearing variables. E.g.: `'--setTearingVars=4,2,3,5'` would select variables 3 and 5 in strong component 4.

Unknown default valueFlags.FlagData.INT_LIST_FLAG(data = {NIL})

--setResidualEqns

Sets the residual equations by its strong component indexes. Use `'-d=tearingdump'` to find out the relevant indexes for the collective equations. Use following format: `'--setResidualEqns=(sci,n,r1,...,rn)*'`, with `sci` = strong component index, `n` = number of residual equations, `r1,...,rn` = residual equations. E.g.: `'--setResidualEqns=4,2,3,5'` would select equations 3 and 5 in strong component 4. Only works in combination with `'setTearingVars'`.

Unknown default valueFlags.FlagData.INT_LIST_FLAG(data = {NIL})

--ignoreCommandLineOptionsAnnotation

Ignores the command line options specified as annotation in the class.

Boolean (default *false*).

--calculateSensitivities

Generates sensitivities variables and matrixes.

Boolean (default `false`).

-r, --alarm

Sets the number seconds until omc timeouts and exits. Used by the testing framework to terminate infinite running processes.

Integer (default 0).

--totalTearing

Activates total tearing (determination of all possible tearing sets) for the specified components. Use '`d=tearingdump`' to find out the relevant indexes.

Unknown default value `Flags.FlagData.INT_LIST_FLAG(data = {NIL})`

--ignoreSimulationFlagsAnnotation

Ignores the simulation flags specified as annotation in the class.

Boolean (default `false`).

--dynamicTearingForInitialization

Enable Dynamic Tearing also for the initialization system.

Boolean (default `false`).

--preferTVarsWithStartValue

Prefer tearing variables with start value for initialization.

Boolean (default `true`).

--equationsPerFile

Generate code for at most this many equations per C-file (partially implemented in the compiler).

Integer (default 2000).

--evaluateFinalParameters

Evaluates all the final parameters in addition to parameters with annotation(`Evaluate=true`).

Boolean (default `false`).

--evaluateProtectedParameters

Evaluates all the protected parameters in addition to parameters with annotation(`Evaluate=true`).

Boolean (default `false`).

--replaceEvaluatedParameters

Replaces all the evaluated parameters in the DAE.

Boolean (default `true`).

--condenseArrays

Sets whether array expressions containing function calls are condensed or not.

Boolean (default `true`).

--wfcAdvanced

`wrapFunctionCalls` ignores more then default cases, e.g. `exp`, `sin`, `cos`, `log`, (experimental flag)

Boolean (default `false`).

--tearingStrictness

Sets the strictness of the tearing method regarding the solvability restrictions.

String (default `strict`). Valid options:

- casual (Loose tearing rules using ExpressionSolve to determine the solvability instead of considering the partial derivative. Allows to solve for everything that is analytically possible. This could lead to singularities during simulation.)
- strict (Robust tearing rules by consideration of the partial derivative. Allows to divide by parameters that are not equal to or close to zero.)
- veryStrict (Very strict tearing rules that do not allow to divide by any parameter. Use this if you aim at overriding parameters after compilation with values equal to or close to zero.)

--interactive

Sets the interactive mode for omc.

String (default none). Valid options:

- none (do nothing)
- corba (Starts omc as a server listening on the socket interface.)
- tcp (Starts omc as a server listening on the Corba interface.)
- zmq (Starts omc as a ZeroMQ server listening on the socket interface.)

-z, --zeroMQFileSuffix

Sets the file suffix for zeroMQ port file if `--interactive=zmq` is used.

String (default empty).

--homotopyApproach

Sets the homotopy approach.

String (default equidistantGlobal). Valid options:

- equidistantLocal (Local homotopy approach with equidistant lambda steps. The homotopy parameter only effects the local strongly connected component.)
- adaptiveLocal (Local homotopy approach with adaptive lambda steps. The homotopy parameter only effects the local strongly connected component.)
- equidistantGlobal (Default, global homotopy approach with equidistant lambda steps. The homotopy parameter effects the entire initialization system.)
- adaptiveGlobal (Global homotopy approach with adaptive lambda steps. The homotopy parameter effects the entire initialization system.)

--ignoreReplaceable

Sets whether to ignore replaceability or not when redeclaring.

Boolean (default false).

--postOptModulesDAE

Sets the optimization modules for the DAE mode in the back end. See `--help=optmodules` for more info.

String list (default lateInlineFunction,wrapFunctionCalls,simplifysemiLinear,simplifyComplexFunction,removeConstants,simplifyT

--evalLoopLimit

The loop iteration limit used when evaluating constant function calls.

Integer (default 100000).

--evalRecursionLimit

The recursion limit used when evaluating constant function calls.

Integer (default 256).

--singleInstanceAglSolver

Sets to instantiate only one algebraic loop solver all algebraic loops

Boolean (default false).

--showStructuralAnnotations

Show annotations affecting the solution process in the flattened code.

Boolean (default `false`).

--initialStateSelection

Activates the state selection inside initialization to avoid singularities.

Boolean (default `false`).

--linearizationDumpLanguage

Sets the target language for the produced code of linearization. Only works with '`--generateSymbolicLinearization`' and '`linearize(modelName)`'.

String (default `modelica`). Valid options:

- `modelica`
- `matlab`
- `julia`
- `python`

--noASSC

Disables analytical to structural singularity conversion.

Boolean (default `false`).

--fullASSC

Enables full equation replacement for BLT transformation from the ASSC algorithm.

Boolean (default `false`).

--maxSizeASSC

Sets the maximum system size for the analytical to structural conversion algorithm (default 200).

Integer (default 200).

--useZeroMQInSim

Configures to use zeroMQ in simulation runtime to exchange information via ZeroMQ with other applications

Boolean (default `false`).

--zeroMQPubPort

Configures port number for simulation runtime to send information via ZeroMQ

Integer (default 3203).

--zeroMQSubPort

Configures port number for simulation runtime to receive information via ZeroMQ

Integer (default 3204).

--zeroMQJOBID

Configures the ID with which the `omc api` call is labelled for zeroMQ communication.

String (default empty).

--zeroMQServerID

Configures the ID with which server application is labelled for zeroMQ communication.

String (default empty).

--zeroMQClientID

Configures the ID with which the client application is labelled for zeroMQ communication.

String (default empty).

-f, --flatModelica

Outputs experimental flat Modelica.

Boolean (default `false`).

--fmiFilter

Specifies which model variables get exposed by the `modelDescription.xml`

String (default `internal`). Valid options:

- `none` (All variables will be exposed, even variables that are introduced by the symbolic transformations. Hence, this is intended to be used for debugging.)
- `internal` (All internal variables introduced by the symbolic transformations are filtered out. Only the variables from the actual Modelica model are exposed (with minor exceptions, e.g. for state sets).)
- `protected` (All protected model variables will be filtered out in addition to `--fmiFilter=internal`.)
- `blackBox` (This option is used to hide everything except for inputs and outputs. Additional variables that need to be present in the `modelDescription` file for structural reasons will have concealed names.)

--fmiSources

Defines if FMUs will be exported with sources or not. `--fmiFilter=blackBox` might override this, because black box FMUs do never contain their source code.

Boolean (default `true`).

--fmiFlags

Add simulation flags to FMU. Will create `<fmiPrefix>_flags.json` in resources folder with given flags. Use `--fmiFlags` or `--fmiFlags=none` to disable [default]. Use `--fmiFlags=default` for the default simulation flags. To pass flags use e.g. `--fmiFlags=s:cvode,nls:homotopy` or `--fmiFlags=path/to/yourFlags.json`.

String list (default `empty`).

--newBackend

Activates experimental new backend for better array handling. This also activates the new frontend. [WIP]

Boolean (default `false`).

26.2 Debug flags

The debug flag takes a comma-separated list of flags which are used by the compiler for debugging or experimental purposes. Flags prefixed with "-" or "no" will be disabled. The available flags are (+ are enabled by default, - are disabled):

***Cache* (default: on)** Turns off the instantiation cache.

***LSanalyticJacobian* (default: off)** Enables analytical jacobian for linear strong components. Defaults to false

***NLSanalyticJacobian* (default: on)** Enables analytical jacobian for non-linear strong components without user-defined function calls, for that see `forceNLSanalyticJacobian`

***acceptTooManyFields* (default: off)** Accepts passing records with more fields than expected to a function. This is not allowed, but is used in `Fluid.Dissipation`. See <https://trac.modelica.org/Modelica/ticket/1245> for details.

***addDerAliases* (default: off)** Adds for every der-call an alias equation e.g. `dx = der(x)`. It's a work-a-round flag, which helps in some cases to simulate the models e.g. `Modelica.Fluid.Examples.HeatExchanger.HeatExchangerSimulation`. **Deprecated flag:** Use `--preOptModules+=introduceDerAlias` instead.

***addScaledVars* (default: off)** Adds an alias equation `var_nrom = var/nominal` where `var` is state **Deprecated flag:** Use `--postOptModules+=addScaledVars_states` instead.

***addScaledVarsInput* (default: off)** Adds an alias equation `var_nrom = var/nominal` where `var` is input **Deprecated flag:** Use `--postOptModules+=addScaledVars_inputs` instead.

- aliasConflicts* (default: off) Dumps alias sets with different start or nominal values.
- backendKeepEnv* (default: on) When enabled, the environment is kept when entering the backend, which enables CevalFunction (function interpretation) to work. This module not essential for the backend to function in most cases, but can improve simulation performance by evaluating functions. The drawback to keeping the environment graph in memory is that it is huge (~80% of the total memory in use when returning the frontend DAE).
- backendReduceDAE* (default: off) Prints all Reduce DAE debug information.
- backendaeinfor* (default: off) Enables dumping of back-end information about system (Number of equations before back-end,...).
- bltdump* (default: off) Dumps information from index reduction.
- bltmatrixdump* (default: off) Dumps the blt matrix in html file. IE seems to be very good in displaying large matrices.
- buildExternalLibs* (default: on) Use the autotools project in the Resources folder of the library to build missing external libraries.
- ceval* (default: off) Prints extra information from Ceval.
- cgraph* (default: off) Prints out connection graph information.
- cgraphGraphVizFile* (default: off) Generates a graphviz file of the connection graph.
- cgraphGraphVizShow* (default: off) Displays the connection graph with the GraphViz lefty tool.
- checkASUB* (default: off) Prints out a warning if an ASUB is created from a CREF expression.
- checkBackendDae* (default: off) Do some simple analyses on the datastructure from the frontend to check if it is consistent.
- checkDAECrefType* (default: off) Enables extra type checking for cref expressions.
- checkSimplify* (default: off) Enables checks for expression simplification and prints a notification whenever an undesirable transformation has been performed.
- constjac* (default: off) solves linear systems with constant Jacobian and variable b-Vector symbolically
- countOperations* (default: off) Count operations.
- daedumpgraphv* (default: off) Dumps the DAE in graphviz format.
- dataReconciliation* (default: off) Dumps all the dataReconciliation extraction algorithm procedure
- debugAlgebraicLoops.Jacobian* (default: off) Dumps debug output while creating symbolic jacobians for non-linear systems.
- debugAlias* (default: off) Dumps some information about the process of removeSimpleEquations.
- debugDAEmode* (default: off) Dump debug output for the DAEmode.
- debugDifferentiation* (default: off) Dumps debug output for the differentiation process.
- debugDifferentiationVerbose* (default: off) Dumps verbose debug output for the differentiation process.
- disableColoring* (default: off) Disables coloring algorithm while sparsity detection.
- disableComSubExp* (default: off) Deactivates module 'comSubExp' Deprecated flag: Use --preOptModules=`=comSubExp` instead.
- disableDirectionalDerivatives* (default: on) For FMI 2.0 only dependency analysis will be perform.
- disableFMIDependency* (default: off) Disables the dependency analysis and generation for FMI 2.0.
- disableJacforSCC* (default: off) Disables calculation of jacobians to detect if a SCC is linear or non-linear. By disabling all SCC will handled like non-linear.
- disablePartitioning* (default: off) Deactivates partitioning of entire equation system. Deprecated flag: Use --preOptModules=`=clockPartitioning` instead.
- disableRecordConstructorOutput* (default: off) Disables output of record constructors in the flat code.

- disableSimplifyComplexFunction* (**default: off**) disable simplifyComplexFunction Deprecated flag: Use --postOptModules==simplifyComplexFunction/--initOptModules==simplifyComplexFunction instead.
- disableSingleFlowEq* (**default: off**) Disables the generation of single flow equations.
- disableStartCalc* (**default: off**) Deactivates the pre-calculation of start values during compile-time.
- disableWindowsPathCheckWarning* (**default: off**) Disables warnings on Windows if OPENMODELICA-HOME/MinGW is missing.
- discreteinfo* (**default: off**) Enables dumping of discrete variables. Extends -d=backenddaeinfo.
- dummyselect* (**default: off**) Dumps information from dummy state selection heuristic.
- dump* (**default: off**) Dumps the absyn representation of a program.
- dumpASSC* (**default: off**) Dumps the conversion process of analytical to structural singularities.
- dumpBackendInline* (**default: off**) Dumps debug output while inline function.
- dumpBackendInlineVerbose* (**default: off**) Dumps debug output while inline function.
- dumpCSE* (**default: off**) Additional output for CSE module.
- dumpCSE_verbose* (**default: off**) Additional output for CSE module.
- dumpConstrepl* (**default: off**) Dump the found replacements for constants.
- dumpEArepl* (**default: off**) Dump the found replacements for evaluate annotations (evaluate=true) parameters.
- dumpEncapsulateConditions* (**default: off**) Dumps the results of the preOptModule encapsulateWhenConditions.
- dumpEqInUC* (**default: off**) Dumps all equations handled by the unit checker.
- dumpEqUCStruct* (**default: off**) Dumps all the equations handled by the unit checker as tree-structure.
- dumpExcludedSymJacExps* (**default: off**) This flags dumps all expression that are excluded from differentiation of a symbolic Jacobian.
- dumpFPrepl* (**default: off**) Dump the found replacements for final parameters.
- dumpFunctions* (**default: off**) Add functions to backend dumps.
- dumpHomotopy* (**default: off**) Dumps the results of the postOptModule optimizeHomotopyCalls.
- dumpInlineSolver* (**default: off**) Dumps the inline solver equation system.
- dumpJL* (**default: off**) Dumps the absyn representation of a program as a Julia representation
- dumpLoops* (**default: off**) Dumps loop equation.
- dumpLoopsVerbose* (**default: off**) Dumps loop equation and enhanced adjacency matrix.
- dumpPPrepl* (**default: off**) Dump the found replacements for protected parameters.
- dumpParamrepl* (**default: off**) Dump the found replacements for remove parameters.
- dumpRecursiveTearing* (**default: off**) Dump between steps of recursiveTearing
- dumpSCCGraphML* (**default: off**) Dumps graphml files with the strongly connected components.
- dumpSimCode* (**default: off**) Dumps the simCode model used for code generation.
- dumpSimplifyLoops* (**default: off**) Dump between steps of simplifyLoops
- dumpSortEqnsAndVars* (**default: off**) Dumps debug output for the modules sortEqnsVars.
- dumpSparsePattern* (**default: off**) Dumps sparse pattern with coloring used for simulation.
- dumpSparsePatternVerbose* (**default: off**) Dumps in verbose mode sparse pattern with coloring used for simulation.
- dumpSynchronous* (**default: off**) Dumps information of the clock partitioning.
- dumpTransformedModelica* (**default: off**) Dumps the back-end DAE to a Modelica-like model after all symbolic transformations are applied.
- dumpUnits* (**default: off**) Dumps all the calculated units.

- dumpdaelow* (**default: off**) Dumps the equation system at the beginning of the back end.
- dumpdgesv* (**default: off**) Enables dumping of the information whether DGESV is used to solve linear systems.
- dumppeqinorder* (**default: off**) Enables dumping of the equations in the order they are calculated.
- dumpindxdae* (**default: off**) Dumps the equation system after index reduction and optimization.
- dumpinitialsystem* (**default: off**) Dumps the initial equation system.
- dumprepl* (**default: off**) Dump the found replacements for simple equation removal.
- dynload* (**default: off**) Display debug information about dynamic loading of compiled functions.
- evalConstFuncs* (**default: on**) Evaluates functions complete and partially and checks for constant output. Deprecated flag: Use `--preOptModules+=evalFunc` instead.
- evalFuncDump* (**default: off**) dumps debug information about the function evaluation
- evalOutputOnly* (**default: off**) Generates equations to calculate outputs only.
- evalParameterDump* (**default: off**) Dumps information for evaluating parameters.
- evalfunc* (**default: on**) Turns on/off symbolic function evaluation.
- evaluateAllParameters* (**default: off**) Evaluates all parameters if set.
- events* (**default: on**) Turns on/off events handling.
- execHash* (**default: off**) Measures the time it takes to hash all simcode variables before code generation.
- execstat* (**default: off**) Prints out execution statistics for the compiler.
- execstatGCcollect* (**default: off**) When running `execstat`, also perform an extra full garbage collection.
- experimentalReductions* (**default: off**) Turns on custom reduction functions (OpenModelica extension).
- failtrace* (**default: off**) Sets whether to print a failtrace or not.
- fmuExperimental* (**default: off**) Include an extra function in the FMU `fmi2GetSpecificDerivatives`.
- force-fmi-attributes* (**default: off**) Force to export all fmi attributes to the `modelDescription.xml`, including those which have default values
- forceNLSanalyticJacobian* (**default: off**) Forces calculation analytical jacobian also for non-linear strong components with user-defined functions.
- frontEndUnitCheck* (**default: off**) Checks the consistency of units in equation.
- gcProfiling* (**default: off**) Prints garbage collection stats to standard output.
- gen* (**default: off**) Turns on/off dynamic loading of functions that are compiled during translation. Only enable this if external functions are needed to calculate structural parameters or constants.
- gendebugsymbols* (**default: off**) Generate code with debugging symbols.
- generateCodeCheat* (**default: off**) Used to generate code for the bootstrapped compiler.
- graphInst* (**default: off**) Do graph based instantiation.
- graphInstGenGraph* (**default: off**) Dumps a graph of the program. Use with `-d=graphInst`
- graphInstRunDep* (**default: off**) Run scode dependency analysis. Use with `-d=graphInst`
- graphInstShowGraph* (**default: off**) Display a graph of the program interactively. Use with `-d=graphInst`
- graphml* (**default: off**) Dumps `.graphml` files for the bipartite graph after Index Reduction and a task graph for the SCCs. Can be displayed with `yEd`.
- graphviz* (**default: off**) Dumps the absyn representation of a program in `graphviz` format.
- graphvizDump* (**default: off**) Activates additional `graphviz` dumps (as `.dot` files). It can be used in addition to one of the following flags: `{dumpdaelow|dumpinitialsystems|dumpindxdae}`.
- hardcodedStartValues* (**default: off**) Embed the start values of variables and parameters into the `c++` code and do not read it from `xml` file.
- hpcom* (**default: off**) Enables parallel calculation based on task-graphs.

- hpcomDump* (default: off) Dumps additional information on the parallel execution with hpcom.
- hpcomMemoryOpt* (default: off) Optimize the memory structure regarding the selected scheduler
- ignoreCycles* (default: off) Ignores cycles between constant/parameter components.
- implOde* (default: off) activates implicit codegen
- infoXmlOperations* (default: off) Enables output of the operations in the _info.xml file when translating models.
- initialization* (default: off) Shows additional information from the initialization process.
- inlineFunctions* (default: on) Controls if function inlining should be performed.
- inlineSolver* (default: off) Generates code for inline solver.
- instance* (default: off) Prints extra failtrace from InstanceHierarchy.
- interactive* (default: off) Starts omc as a server listening on the socket interface.
- interactiveCorba* (default: off) Starts omc as a server listening on the Corba interface.
- interactivedump* (default: off) Prints out debug information for the interactive server.
- iterationVars* (default: off) Shows a list of all iteration variables.
- listAppendWrongOrder* (default: on) Print notifications about bad usage of listAppend.
- lookup* (default: off) Print extra failtrace from lookup.
- mergeAlgSections* (default: off) Disables coloring algorithm while sparsity detection.
- metaModelicaRecordAllocWords* (default: off) Instrument the source code to record memory allocations (requires run-time and generated files compiled with -DOMC_RECORD_ALLOC_WORDS).
- multirate* (default: off) The solver can switch partitions in the system.
- newInst* (default: off) Enables experimental new instantiation phase.
- nfAPI* (default: off) Enables experimental new instantiation use in the OMC API.
- nfAPIDynamicSelect* (default: off) Show DynamicSelect(static, dynamic) in annotations. Default to false and will select the first (static) expression
- nfAPINoise* (default: off) Enables error display for the experimental new instantiation use in the OMC API.
- nfDumpFlat* (default: off) Dumps the flat model structure before generating the DAE.
- nfEvalConstArgFuncs* (default: on) Evaluate all functions with constant arguments in the new frontend.
- nfExpandFuncArgs* (default: off) Expand all function arguments in the new frontend.
- nfExpandOperations* (default: on) Expand all unary/binary operations to scalar expressions in the new frontend.
- nfScalarize* (default: on) Run scalarization in NF, default true.
- oldFrontEndUnitCheck* (default: off) Checks the consistency of units in equation (for the old front-end).
- onRelaxation* (default: off) Perform O(n) relaxation. Deprecated flag: Use --postOptModules+=relaxSystem instead.
- optdaedump* (default: off) Dumps information from the optimization modules.
- parallelCodegen* (default: on) Enables code generation in parallel (disable this if compiling a model causes you to run out of RAM).
- paramlowdump* (default: off) Enables dumping of the parameters in the order they are calculated.
- parmodauto* (default: off) Experimental: Enable parallelization of independent systems of equations in the translated model.
- partitionInitialization* (default: on) This flag controls if partitioning is applied to the initialization system.
- patternmAllInfo* (default: off) Adds notifications of all pattern-matching optimizations that are performed.
- patternmDeadCodeElimination* (default: on) Performs dead code elimination in match-expressions.
- patternmMoveLastExp* (default: on) Optimization that moves the last assignment(s) into the result of a match-expression. For example: equation $c = \text{fn}(b)$; then $c; \Rightarrow$ then $\text{fn}(b)$;

patternmSkipFilterUnusedBindings (default: off)

printStructuralParameters (default: off) Prints the structural parameters identified by the front-end

pthreads (default: off) Experimental: Unused parallelization.

reduceDynOpt (default: off) remove eqs which not need for the calculations of cost and constraints Deprecated
flag: Use --postOptModules+=reduceDynamicOptimization instead.

reliDx (default: off) Prints out debug information about relations, that are used as zero crossings.

relocatableFunctions (default: off) Generates relocatable code: all functions become function pointers and can be replaced at run-time.

reportSerializedSize (default: off) Reports serialized sizes of various data structures used in the compiler.

reshufflePost (default: off) Reshuffles the systems of equations.

resolveLoopsDump (default: off) Debug Output for ResolveLoops Module.

rml (default: off) Converts Modelica-style arrays to lists.

runtimeStaticLinking (default: off) Use the static simulation runtime libraries (C++ simulation runtime).

scodeDep (default: on) Does scode dependency analysis prior to instantiation. Defaults to true.

semiLinear (default: off) Enables dumping of the optimization information when optimizing calls to semiLinear.

shortOutput (default: off) Enables short output of the simulate() command. Useful for tools like OMNotebook.

showDaeGeneration (default: off) Show the dae variable declarations as they happen.

showEquationSource (default: off) Display the element source information in the dumped DAE for easier debugging.

showExpandableInfo (default: off) Show information about expandable connector handling.

showInstCacheInfo (default: off) Prints information about instantiation cache hits and additions. Defaults to false.

showStartOrigin (default: off) Enables dumping of the DAE startOrigin attribute of the variables.

showStatement (default: off) Shows the statement that is currently being evaluated when evaluating a script.

skipInputOutputSyntacticSugar (default: off) Used when bootstrapping to preserve the input output parsing of the code output by the list command.

stateselection (default: off) Enables dumping of selected states. Extends -d=backenddaefinfo.

static (default: off) Enables extra debug output from the static elaboration.

stripPrefix (default: on) Strips the environment prefix from path/crefs. Defaults to true.

susanDebug (default: off) Makes Susan generate code using try/else to better debug which function broke the expected match semantics.

symJacConstantSplit (default: off) Generates all symbolic Jacobians with splitted constant parts.

symjacdump (default: off) Dumps information about symbolic Jacobians. Can be used only with postOptModules: generateSymbolicJacobian, generateSymbolicLinearization.

symjacdumppeqn (default: off) Dump for debug purpose of symbolic Jacobians. (deactivated now).

symjacdumpverbose (default: off) Dumps information in verbose mode about symbolic Jacobians. Can be used only with postOptModules: generateSymbolicJacobian, generateSymbolicLinearization.

symjacwarnings (default: off) Prints warnings regarding symoblic jacobians.

tail (default: off) Prints out a notification if tail recursion optimization has been applied.

tearingdump (default: off) Dumps tearing information.

tearingdumpV (default: off) Dumps verbose tearing information.

totaltearingdump (default: off) Dumps total tearing information.

totaltearingdumpV (default: off) Dumps verbose total tearing information.

tplPerfTimes (default: off) Enables output of template performance data for rendering text to file.

transformsbeforedump (default: off) Applies transformations required for code generation before dumping flat code.

types (default: off) Prints extra failtrace from Types.

uncertainties (default: off) Enables dumping of status when calling modelEquationsUC.

updmmod (default: off) Prints information about modification updates.

useMPI (default: off) Add MPI init and finalize to main method (CPPruntime).

vectorize (default: off) Activates vectorization in the backend.

visxml (default: off) Outputs a xml-file that contains information for visualization.

warnMinMax (default: on) Makes a warning assert from min/max variable attributes instead of error.

warnNoNominal (default: off) Prints the iteration variables in the initialization and simulation DAE, which do not have a nominal value.

writeToBuffer (default: off) Enables writing simulation results to buffer.

26.3 Flags for Optimization Modules

Flags that determine which symbolic methods are used to produce the causalized equation system.

The *--preOptModules* flag sets the optimization modules which are used before the matching and index reduction in the back end. These modules are specified as a comma-separated list.

The *--matchingAlgorithm* sets the method that is used for the matching algorithm, after the pre optimization modules.

The *--indexReductionMethod* sets the method that is used for the index reduction, after the pre optimization modules.

The *--initOptModules* then sets the optimization modules which are used after the index reduction to optimize the system for initialization, specified as a comma-separated list.

The *--postOptModules* then sets the optimization modules which are used after the index reduction to optimize the system for simulation, specified as a comma-separated list.

SMALL OVERVIEW OF SIMULATION FLAGS

This chapter contains a *short overview of simulation flags* as well as additional details of the *numerical integration methods*.

27.1 OpenModelica (C-runtime) Simulation Flags

The simulation executable takes the following flags:

-abortSlowSimulation Aborts if the simulation chatters.

-alarm=value or -alarm value Aborts after the given number of seconds (default=0 disables the alarm).

-clock=value or -clock value Selects the type of clock to use. Valid options include:

- RT (monotonic real-time clock)
- CYC (cpu cycles measured with RDTSC)
- CPU (process-based CPU-time)

-cpu Dumps the cpu-time into the result file using the variable named \$cpuTime.

-csvOstep=value or -csvOstep value Value specifies csv-files for debug values for optimizer step.

-cvsdeNonlinearSolverIteration=value or -cvsdeNonlinearSolverIteration value Nonlinear solver iteration for CVODE solver. Default: Depends on flag cvsdeLinearMultistepMethod. Valid values

- **CV_NEWTON - Newton iteration.** Advised to use together with flag -cvsdeLinearMultistepMethod=CV_BDF.
- **CV_FUNCTIONAL - Functional iteration.** Advised to use together with flag -cvsdeLinearMultistepMethod=CV_ADAMS.

-cvsdeLinearMultistepMethod=value or -cvsdeLinearMultistepMethod value Linear multistep method for CVODE solver. Default: CV_BDF. Valid values

- **CV_BDF - BDF linear multistep method for stiff problems.** Use together with flag -cvsdeNonlinearSolverIteration=CV_NEWTON or don't set cvsdeNonlinearSolverIteration.
- **CV_ADAMS - Adams-Moulton linear multistep method for nonstiff problems.** Use together with flag -cvsdeNonlinearSolverIteration=CV_FUNCTIONAL or don't set cvsdeNonlinearSolverIteration.

-daeMode Enables daeMode simulation if the model was compiled with the omc flag --daeMode and ida method is used.

-deltaXLinearize=value or -deltaXLinearize value Value specifies the delta x value for numerical differentiation used by linearization. The default value is $\sqrt{\text{DBL_EPSILON} \cdot 2e1}$.

-deltaXSolver=value or -deltaXSolver value Value specifies the delta x value for numerical differentiation used by integration method. The default values is $\sqrt{\text{DBL_EPSILON}}$.

-embeddedServer=value or -embeddedServer value Enables an embedded server. Valid values:

- none - default, run without embedded server

- `opc-da` - [broken] run with embedded OPC DA server (WIN32 only, uses proprietary OPC SC interface)
- `opc-ua` - [experimental] run with embedded OPC UA server (TCP port 4841 for now; will have its own configuration option later)
- `filename` - path to a shared object implementing the embedded server interface (requires access to internal OMC data-structures if you want to read or write data)

`-embeddedServerPort=value` or `-embeddedServerPort value` Value specifies the port number used by the embedded server. The default value is 4841.

`-mat_sync=value` or `-mat_sync value` Syncs the mat file header after emitting every N time-points.

`-emit_protected` Emits protected variables to the result-file.

`-eps=value` or `-eps value` Value specifies the number of convergence iteration to be performed for DataReconciliation

`-f=value` or `-f value` Value specifies a new setup XML file to the generated simulation code.

`-help=value` or `-help value` Get detailed information that specifies the command-line flag

For example, `-help=f` prints detailed information for command-line flag `f`.

`-homAdaptBend=value` or `-homAdaptBend value` Maximum trajectory bending to accept the homotopy step. Default: 0.5, which means the corrector vector has to be smaller than half of the predictor vector.

`-homBacktraceStrategy=value` or `-homBacktraceStrategy value` Value specifies the backtrace strategy in the homotopy corrector step. Valid values:

- `fix` - default, go back to the path by fixing one coordinate
- `orthogonal` - go back to the path in an orthogonal direction to the tangent vector

`-homHEps=value` or `-homHEps value` Tolerance respecting residuals for the homotopy H-function (default: 1e-5).

In the last step (`lambda=1`) `newtonFTol` is used as tolerance.

`-homMaxLambdaSteps=value` or `-homMaxLambdaSteps value` Maximum lambda steps allowed to run the homotopy path (default: `system size * 100`).

`-homMaxNewtonSteps=value` or `-homMaxNewtonSteps value` Maximum newton steps in the homotopy corrector step (default: 20).

`-homMaxTries=value` or `-homMaxTries value` Maximum number of tries for one homotopy lambda step (default: 10).

`-homNegStartDir` Start to run along the homotopy path in the negative direction.

If one direction fails, the other direction is always used as fallback option.

`-homotopyOnFirstTry` If the model contains the homotopy operator, directly use the homotopy method to solve the initialization problem. Without this flag, the solver first tries to solve the initialization problem without homotopy and only uses homotopy as fallback option.

`-noHomotopyOnFirstTry` Disable the use of the homotopy method to solve the initialization problem. Without this flag, the solver tries to solve the initialization problem with homotopy if the model contains the homotopy-operator.

`-homTauDecFac=value` or `-homTauDecFac value` Decrease homotopy step size `tau` by this factor if `tau` is too big in the homotopy corrector step (default: 10.0).

`-homTauDecFacPredictor=value` or `-homTauDecFacPredictor value` Decrease homotopy step size `tau` by this factor if `tau` is too big in the homotopy predictor step (default: 2.0).

`-homTauIncFac=value` or `-homTauIncFac value` Increase homotopy step size `tau` by this factor if `tau` can be increased after the homotopy corrector step (default: 2.0).

`-homTauIncThreshold=value` or `-homTauIncThreshold value` Increase the homotopy step size `tau` if `homAdaptBend/bend > homTauIncThreshold` (default: 10).

- homTauMax=value or -homTauMax value** Maximum homotopy step size tau for the homotopy process (default: 10).
- homTauMin=value or -homTauMin value** Minimum homotopy step size tau for the homotopy process (default: 1e-4).
- homTauStart=value or -homTauStart value** Homotopy step size tau at the beginning of the homotopy process (default: 0.2).
- idaMaxErrorTestFails=value or -idaMaxErrorTestFails value** Value specifies the maximum number of error test failures in attempting one step. The default value is 7.
- idaMaxNonLinIters=value or -idaMaxNonLinIters value** Value specifies the maximum number of nonlinear solver iterations at one step. The default value is 3.
- idaMaxConvFails=value or -idaMaxConvFails value** Value specifies the maximum number of nonlinear solver convergence failures at one step. The default value is 10.
- idaNonLinConvCoef=value or -idaNonLinConvCoef value** Value specifies the safety factor in the nonlinear convergence test. The default value is 0.33.
- idaLS=value or -idaLS value** Value specifies the linear solver of the ida integration method. Valid values:
- dense (ida internal dense method.)
 - klu (ida use sparse direct solver KLU. (default))
 - spgmr (ida generalized minimal residual method. Iterative method)
 - spbcg (ida Bi-CGStab. Iterative method)
 - sptfqmr (ida TFQMR. Iterative method)
- idaScaling** Enable scaling of the IDA solver.
- idaSensitivity** Enables sensitivity analysis with respect to parameters if the model is compiled with omc flag --calculateSensitivities.
- ignoreHideResult** Emits also variables with HideResult=true annotation.
- iif=value or -iif value** Value specifies an external file for the initialization of the model.
- iim=value or -iim value** Value specifies the initialization method. Following options are available: 'symbolic' (default) and 'none'.
- none (sets all variables to their start values and skips the initialization process)
 - symbolic (solves the initialization problem symbolically - default)
- iit=value or -iit value** Value [Real] specifies a time for the initialization of the model.
- ils=value or -ils value** Value specifies the number of steps for homotopy method (required: -iim=symbolic). The value is an Integer with default value 4.
- impRKOrder=value or -impRKOrder value** Value specifies the integration order of the implicit Runge-Kutta method. Valid values: 1 to 6. Default order is 5.
- impRKLS=value or -impRKLS value** Selects the linear solver of the integration methods impeuler, trapezoid and imprungekuta:
- iterativ - default, sparse iterativ linear solver with fallback case to dense solver
 - dense - dense linear solver, SUNDIALS default method
- initialStepSize=value or -initialStepSize value** Value specifies an initial step size, used by the methods: dassl, ida
- csvInput=value or -csvInput value** Value specifies an csv-file with inputs for the simulation/optimization of the model
- exInputFile=value or -exInputFile value** Value specifies an external file with inputs for the simulation/optimization of the model.
- stateFile=value or -stateFile value** Value specifies an file with states start values for the optimization of the model.

-inputPath=value or -inputPath value Value specifies a path for reading the input files i.e., model_init.xml and model_info.json

-ipopt_hesse=value or -ipopt_hesse value Value specifies the hessematrix for Ipopt(OMC, BFGS, const).

-ipopt_init=value or -ipopt_init value Value specifies the initial guess for optimization (sim, const).

-ipopt_jac=value or -ipopt_jac value Value specifies the Jacobian for Ipopt(SYM, NUM, NUMDENSE).

-ipopt_max_iter=value or -ipopt_max_iter value Value specifies the max number of iteration for ipopt.

-ipopt_warm_start=value or -ipopt_warm_start value Value specifies lvl for a warm start in ipopt: 1,2,3,...

-jacobian=value or -jacobian value Select the calculation method for Jacobian used by the integration method:

- coloredNumerical (Colored numerical Jacobian, which is default for dassl and ida. With option -idaLS=klu a sparse matrix is used.)
- internalNumerical (Dense solver internal numerical Jacobian.)
- coloredSymbolical (Colored symbolical Jacobian. Needs omc compiler flag --generateSymbolicalJacobian. With option -idaLS=klu a sparse matrix is used.)
- numerical (Dense numerical Jacobian.)
- symbolical (Dense symbolical Jacobian. Needs omc compiler flag --generateSymbolicalJacobian.)

-jacobianThreads=value or -jacobianThreads value Value specifies the number of threads for jacobian evaluation in dassl or ida. The value is an Integer with default value 1.

-l=value or -l value Value specifies a time where the linearization of the model should be performed.

-l_datarec Emit data recovery matrices with model linearization.

-logFormat=value or -logFormat value Value specifies the log format of the executable:

- text (default)
- xml
- xmlltcp (required -port flag)

-ls=value or -ls value Value specifies the linear solver method

- lapack (method using LAPACK LU factorization)
- lis (method using iterative solver Lis)
- klu (method using KLU sparse linear solver)
- umfpack (method using UMFPACK sparse linear solver)
- totalpivot (method using a total pivoting LU factorization for underdetermination systems)
- default (default method - LAPACK with total pivoting as fallback)

-ls_ipopt=value or -ls_ipopt value Value specifies the linear solver method for Ipopt, default mumps. Note: Use if you build ipopt with other linear solver like ma27

-lss=value or -lss value Value specifies the linear sparse solver method

- default (the default sparse linear solver (or a dense solver if there is none available))
- lis (method using iterative solver Lis)
- klu (method using klu sparse linear solver)
- umfpack (method using umfpack sparse linear solver)

-lssMaxDensity=value or -lssMaxDensity value Value specifies the maximum density for using a linear sparse solver. The value is a Double with default value 0.2.

-lssMinSize=value or -lssMinSize value Value specifies the minimum system size for using a linear sparse solver. The value is an Integer with default value 4001.

-lv=value or -lv value Value (a comma-separated String list) specifies which logging levels to enable. Multiple options can be enabled at the same time.

- stdout (this stream is always active, can be disabled with -lv=-stdout)
- assert (this stream is always active, can be disabled with -lv=-assert)
- LOG_DASSL (additional information about dassl solver)
- LOG_DASSL_STATES (outputs the states at every dassl call)
- LOG_DEBUG (additional debug information)
- LOG_DSS (outputs information about dynamic state selection)
- LOG_DSS_JAC (outputs jacobian of the dynamic state selection)
- LOG_DT (additional information about dynamic tearing)
- LOG_DT_CONS (additional information about dynamic tearing (local and global constraints))
- LOG_EVENTS (additional information during event iteration)
- LOG_EVENTS_V (verbose logging of event system)
- LOG_INIT (additional information during initialization)
- LOG_INIT_HOMOTOPY (filter for LOG_INIT to log only homotopy initialization)
- LOG_INIT_V (verbose information during initialization)
- LOG_IPOPT (information from Ipopt)
- LOG_IPOPT_FULL (more information from Ipopt)
- LOG_IPOPT_JAC (check jacobian matrix with Ipopt)
- LOG_IPOPT_HESSE (check hessian matrix with Ipopt)
- LOG_IPOPT_ERROR (print max error in the optimization)
- LOG_JAC (outputs the jacobian matrix used by dassl)
- LOG_LS (logging for linear systems)
- LOG_LS_V (verbose logging of linear systems)
- LOG_NLS (logging for nonlinear systems)
- LOG_NLS_V (verbose logging of nonlinear systems)
- LOG_NLS_HOMOTOPY (logging of homotopy solver for nonlinear systems)
- LOG_NLS_JAC (outputs the jacobian of nonlinear systems)
- LOG_NLS_JAC_TEST (tests the analytical jacobian of nonlinear systems)
- LOG_NLS_RES (outputs every evaluation of the residual function)
- LOG_NLS_EXTRAPOLATE (outputs debug information about extrapolate process)
- LOG_RES_INIT (outputs residuals of the initialization)
- LOG_RT (additional information regarding real-time processes)
- LOG_SIMULATION (additional information about simulation process)
- LOG_SOLVER (additional information about solver process)
- LOG_SOLVER_V (verbose information about the integration process)
- LOG_SOLVER_CONTEXT (context information during the solver process)
- LOG_SOTI (final solution of the initialization)
- LOG_STATS (additional statistics about timer/events/solver)
- LOG_STATS_V (additional statistics for LOG_STATS)
- LOG_SUCCESS (this stream is always active, unless deactivated with -lv=-LOG_SUCCESS)
- LOG_UTIL (???)
- LOG_ZEROCROSSINGS (additional information about the zerocrossings)

-lv_time=value or -lv_time value Interval (a comma-separated Double list with two elements) specifies in which time interval logging is active. Doesn't affect LOG_STDOUT, LOG_ASSERT, and LOG_SUCCESS, LOG_STATS, LOG_STATS_V.

-mbi=value or -mbi value Value specifies the maximum number of bisection iterations for state event detection or zero for default behavior

-mei=value or -mei value Value specifies the maximum number of event iterations. The value is an Integer with default value 20.

-maxIntegrationOrder=value or -maxIntegrationOrder value Value specifies maximum integration order, used by the methods: dassl, ida.

-maxStepSize=value or -maxStepSize value Value specifies maximum absolute step size, used by the methods: dassl, ida.

-measureTimePlotFormat=value or -measureTimePlotFormat value Value specifies the output format of the measure time functionality:

- svg
- jpg
- ps
- gif
- ...

-newtonFTol=value or -newtonFTol value Tolerance respecting residuals for updating solution vector in Newton solver. Solution is accepted if the (scaled) 2-norm of the residuals is smaller than the tolerance newtonFTol and the (scaled) newton correction (delta_x) is smaller than the tolerance newtonXTol. The value is a Double with default value 1e-12.

-newtonMaxStepFactor=value or -newtonMaxStepFactor value Maximum newton step factor mxnewtstep = maxStepFactor * norm2(xScaling). Used currently only by KINSOL.

-newtonXTol=value or -newtonXTol value Tolerance respecting newton correction (delta_x) for updating solution vector in Newton solver. Solution is accepted if the (scaled) 2-norm of the residuals is smaller than the tolerance newtonFTol and the (scaled) newton correction (delta_x) is smaller than the tolerance newtonXTol. The value is a Double with default value 1e-12.

-newton=value or -newton value Value specifies the damping strategy for the newton solver.

- damped (Newton with a damping strategy)
- damped2 (Newton with a damping strategy 2)
- damped_ls (Newton with a damping line search)
- damped_bt (Newton with a damping backtracking and a minimum search via golden ratio method)
- pure (Newton without damping strategy)

-nls=value or -nls value Value specifies the nonlinear solver:

- hybrid (Modification of the Powell hybrid method from minpack - former default solver)
- kinsol (SUNDIALS/KINSOL includes an interface to the sparse direct solver, KLU. See simulation option -nlsLS for more information.)
- newton (Newton Raphson - prototype implementation)
- mixed (Mixed strategy. First the homotopy solver is tried and then as fallback the hybrid solver.)
- homotopy (Damped Newton solver if failing case fixed-point and Newton homotopies are tried.)

-nlsInfo Outputs detailed information about solving process of non-linear systems into csv files.

-nlsLS=value or -nlsLS value Value specifies the linear solver used by the non-linear solver:

- default (chooses the nls linear solver based on which nls is being used.)
- totalpivot (internal total pivot implementation. Solve in some case even under-determined systems.)
- lapack (use external LAPACK implementation.)

- `klu` (use KLU direct sparse solver. Only with KINSOL available.)

-nlssMaxDensity=value or -nlssMaxDensity value Value specifies the maximum density for using a non-linear sparse solver. The value is a Double with default value 0.2.

-nlssMinSize=value or -nlssMinSize value Value specifies the minimum system size for using a non-linear sparse solver. The value is an Integer with default value 10001.

-noemit Do not emit any results to the result file.

-noEquidistantTimeGrid Output the internal steps given by `dassl/ida` instead of interpolating results into an equidistant time grid as given by `stepSize` or `numberOfIntervals`.

-noEquidistantOutputFrequency=value or -noEquidistantOutputFrequency value Integer value `n` controls the output frequency in `noEquidistantTimeGrid` mode and outputs every `n`-th time step

-noEquidistantOutputTime=value or -noEquidistantOutputTime value Real value `timeValue` controls the output time point in `noEquidistantOutputTime` mode and outputs every `time >= k*timeValue`, where `k` is an integer

-noEventEmit Do not emit event points to the result file.

-noRestart Disables the restart of the integration method after an event is performed, used by the methods: `dassl`, `ida`

-noRootFinding Disables the internal root finding procedure of methods: `dassl` and `ida`.

-noScaling Disables scaling for the variables and the residuals in the algebraic nonlinear solver KINSOL.

-noSuppressAlg Flag to not suppress algebraic variables in the local error test of the `ida` solver in `daeMode`. In general, the use of this option is discouraged when solving DAE systems of index 1, whereas it is generally encouraged for systems of index 2 or more.

-optDebugJac=value or -optDebugJac value Value specifies the number of iterations from the dynamic optimization, which will be debugged, creating `.csv` and `.py` files.

-optimizerNP=value or -optimizerNP value Value specifies the number of points in a subinterval. Currently supports numbers 1 and 3.

-optimizerTimeGrid=value or -optimizerTimeGrid value Value specifies external file with time points.

-output=value or -output value Output the variables `a`, `b` and `c` at the end of the simulation to the standard output: `time = value, a = value, b = value, c = value`

-outputPath=value or -outputPath value Value specifies a path for writing the output files i.e., `model_res.mat`, `model_prof.intdata`, `model_prof.realdata` etc.

-override=value or -override value Override the variables or the simulation settings in the XML setup file For example: `var1=start1,var2=start2,par3=start3,startTime=val1,stopTime=val2`

-overrideFile=value or -overrideFile value Will override the variables or the simulation settings in the XML setup file with the values from the file. Note that: `-overrideFile` CANNOT be used with `-override`. Use when variables for `-override` are too many. `overrideFileName` contains lines of the form: `var1=start1`

-port=value or -port value Value specifies the port for simulation status (default disabled).

-r=value or -r value Value specifies the name of the output result file. The default file-name is based on the model name and output format. For example: `Model_res.mat`.

-reconcile Run the DataReconciliation algorithm for constrained equation

-rt=value or -rt value Value specifies the scaling factor for real-time synchronization (0 disables). A value `> 1` means the simulation takes a longer time to simulate.

-s=value or -s value Value specifies the integration method. For additional information see the *User's Guide*

- `euler` - Euler - explicit, fixed step size, order 1
- `heun` - Heun's method - explicit, fixed step, order 2
- `rungekutta` - classical Runge-Kutta - explicit, fixed step, order 4
- `impeuler` - Euler - implicit, fixed step size, order 1

- trapezoid - trapezoidal rule - implicit, fixed step size, order 2
- imprungekutta - Runge-Kutta methods based on Radau and Lobatto IIA - implicit, fixed step size, order 1-6(selected manually by flag -impRKOrder)
- irksco - own developed Runge-Kutta solver - implicit, step size control, order 1-2
- dassl - default solver - BDF method - implicit, step size control, order 1-5
- ida - SUNDIALS IDA solver - BDF method with sparse linear solver - implicit, step size control, order 1-5
- cvode - experimental implementation of SUNDIALS CVODE solver - BDF or Adams-Moulton method - step size control, order 1-12
- rungekuttaSsc - Runge-Kutta based on Novikov (2016) - explicit, step size control, order 4-5 [experimental]
- symSolver - symbolic inline Solver [compiler flag +symSolver needed] - fixed step size, order 1
- symSolverSsc - symbolic implicit Euler with step size control [compiler flag +symSolver needed] - step size control, order 1
- qss - A QSS solver [experimental]
- optimization - Special solver for dynamic optimization

-single Output results in single precision (mat-format only).

-steps Dumps the number of integration steps into the result file.

-steadyState Aborts the simulation if steady state is reached.

-steadyStateTol=value or -steadyStateTol value This relative tolerance is used to detect steady state:
 $\max(|\mathbf{d}(\mathbf{x}_i)/\mathbf{d}t|/\text{nominal}(\mathbf{x}_i)) < \text{steadyStateTol}$

-sx=value or -sx value Value specifies an csv-file with inputs as covariance matrix Sx for DataReconciliation

-keepHessian=value or -keepHessian value Value specifies the number of steps, which keep Hessian matrix constant.

-w Shows all warnings even if a related log-stream is inactive.

TECHNICAL DETAILS

This chapter gives an overview of some implementation details that might be interesting when building tools around OpenModelica.

28.1 The MATv4 Result File Format

The default result-file format of OpenModelica is based on MATLAB level 4 MAT-files as described in the [MATLAB documentation](#). This format can be read by tools such as MATLAB, Octave, Scilab, and SciPy. OpenModelica will write the result-files in a particular way that can be read by tools such as DyMat and Dymola (OpenModelica can also read files generated by Dymola since the used format is the same).

The variables stored in the MAT-file are (in the order required by OpenModelica):

Aclass

- `Aclass(1, :)` is always `Atrajectory`
- `Aclass(2, :)` is `1.1` in OpenModelica
- `Aclass(3, :)` is empty
- `Aclass(4, :)` is either `binTrans` or `binNormal`

The most important part of the variable is `Aclass(4, :)` since there are two main ways the result-file is stored: transposed or not. For efficiency, the result-file is written time-step by time-step during simulation. But the best way to read the data for a single variable is if the variables are stored variable by variable. If `Aclass(4, :)` is `binTrans`, all matrices need to be transposed since the file was not transposed for efficient reading of the file. Note that this affects all matrices, even matrices that do not change during simulation (such as name and description).

name Is an $n \times m$ character (int8) matrix, where n is the number of variables stored in the result-file (including time). m is the length of the longest variable. OpenModelica stores the trailing part of the name as NIL bytes (0) whereas other tools use spaces for the trailing part.

description Is an $n \times m$ character (int8) matrix containing the comment-string corresponding to the variable in the name matrix.

dataInfo Is an $n \times 4$ integer matrix containing information for each variable (in the same order as the name and description matrices).

- `dataInfo(i, 1)` is 1 or 2, saying if variable i is stored in the `data_1` or `data_2` matrix. If it is 0, it is the abscissa (time variable).
- `dataInfo(i, 2)` contains the index in the `data_1` or `data_2` matrix. The index is 1-based and may contain several variables pointing to the same row (alias variables). A negative value means that the variable is a negated alias variable.
- `dataInfo(i, 3)` is 0 to signify linear interpolation. In other tools the value is the number of times differentiable this variable is, which may improve plotting.
- `dataInfo(i, 4)` is `-1` in OpenModelica to signify that the value is not defined outside the time range. 0 keeps the first/last value when going outside the time range and 1 performs linear interpolation on the first/last two points.

data_1 If it is an $n \times 1$ matrix it contains the values of parameters. If it is an $n \times 2$ matrix, the first and second column signify start and stop-values.

data_2 Each row contains the values of a variable at the sampled times. The corresponding time stamps are stored in `data_2(1, :)`. `data_2(2, 1)` is the value of some variable at time `data_2(1, 1)`.

DATARECONCILIATION

The objective of data reconciliation is to use physical models to decrease measurement uncertainties on physical quantities. Data reconciliation is possible only when redundant measurements are available for a given physical quantity.

29.1 Defining DataReconciliation Problem in OpenModelica

To define DataReconciliation Problem in OpenModelica, The Modelica model must be defined with the following

- The list of variables of interest, which is defined in the modelica model as a special variable attribute (`uncertain=Uncertainty.refine`)
- The list of approximated equations. which is defined in the modelica model as a special annotation (`__OpenModelica_ApproximatedEquation=true`)

The list of Variable of interest are mandatory and the list of approximated equations are optional. An example of modelica model with dataReconciliation problem is given below,

```
model Splitter1
  Real Q1(uncertain=Uncertainty.refine);
  Real Q2(uncertain=Uncertainty.refine);
  Real Q3(uncertain=Uncertainty.refine);
  parameter Real P01 =3;
  parameter Real P02 =1;
  parameter Real P03 =1;
  Real T1_P1, T1_P2, T2_P1, T2_P2, T3_P1, T3_P2;
  Real V_Q1, V_Q2, V_Q3;
  Real T1_Q1, T1_Q2, T2_Q1, T2_Q2, T3_Q1, T3_Q2;
  Real P, V_P1, V_P2, V_P3;
equation
  T1_P1 = P01;
  T2_P2 = P02;
  T3_P2 = P03;
  T1_P1 - T1_P2 = Q1^2 annotation (__OpenModelica_ApproximatedEquation=true);
  T2_P1 - T2_P2 = Q2^2 annotation (__OpenModelica_ApproximatedEquation=true);
  T3_P1 - T3_P2 = Q3^2 annotation (__OpenModelica_ApproximatedEquation=true);
  V_Q1 = V_Q2 + V_Q3;
  V_Q1 = T1_Q2;
  T1_Q2 = Q1;
  V_Q2 = T2_Q1;
  T2_Q1 = Q2;
  V_Q3 = T3_Q1;
  T3_Q1 = Q3;
  T1_P2 = V_P1;
  V_P1 = P;
  T2_P1 = V_P2;
  V_P2 = P;
  T3_P1 = V_P3;
  V_P3 = P;
```

(continues on next page)

(continued from previous page)

```
T1_Q1 = Q1;
T2_Q2 = Q2;
T3_Q2 = Q3;
end Splitter1;
```

After defining the modelica model, the users must define the dataReconciliation Input File.

29.1.1 DataReconciliationInputFile

The dataReconciliation Input file is a csv file with the the following headers,

- Variable Names - names of the Uncertainty variables, given in the modelica model
- Measured Value-x – Values given by the users
- HalfWidthConfidenceInterval – Values given by the users, which computes Covariance Matrix Sx
- xi – co-relation- coefficients
- xk - co-relation- coefficients
- rx_ik- value associated with co-relation coefficients

The first 3 column, Variable Names, Measured Value-x and HalfWidthConfidenceInterval are mandatory The remaining column xi, xk, rx_ik are correlation-coefficients which are optional. An example csv file is given below

	A	B	C	D	E	F
1	Variable name	Measured value x	Half-width confidence interval	xi	xk	rx_ik
2	Q1	2.1	1.96			
3	Q2	1.05	1.91			
4	Q3	0.97	1.91			
5						

Figure 29.1: An example DataReconciliationInput file(.csv)

The ordering of variables in the csv files should be defined in correct order on how it is declared in the model, for example in the above example we have uncertain variables defined in the following order Q1,Q2 and Q3 and the same order should be followed for the csv file in order to match the jacobian columns generated for dataReconciliation Otherwise the dataReconciliation procedure computes wrong results.

Now we are ready to run the DataReconciliation procedure in OpenModelica.

29.2 DataReconciliation Support with Scripting Interface

The data Reconciliation procedure is possible to run through OpenModelica scripting interface(.mos file). An example mos script (a.mos) is present below.

```
setCommandLineOptions("--preOptModules+=dataReconciliation");
getErrorString();
loadFile("DataReconciliationSimpleTests/package.mo");
getErrorString();
simulate(DataReconciliationTests.Splitter1,simflags="-reconcile -sx=./Splitter1_Sx.
→csv -eps=0.0023 -lv=LOG_JAC");
getErrorString();
```

To start the dataReconciliation procedure via command line interface, the users have to enable the dataReconciliation module which is done via setCommandLineOptions("--preOptModules+=dataReconciliation") which runs the extraction algorithm for dataReconciliation procedure. And finally the users must specify 3 runtime simulation flags given below

1. reconcile – runtime flag which starts the dataReconciliation Procedure
2. sx – csv file Input
3. eps – small value given by users

The Flag -lv=LOG_JAC is optional and can be used for debugging.

And finally run the mos script(a.mos) with omc

```
>> omc a.mos
```

The HTML Reports, the Csv files and the debugging log are generated in the current directory see [DataReconciliation Results](#).

29.3 DataReconciliation Support in OMEdit

The DataReconciliation setup can be launched by,

- Selecting Simulation > Simulation Setup from the menu. (requires a model to be active in ModelWidget)
- Clicking on the Simulation Setup toolbar button. (requires a model to be active in ModelWidget)
- Right clicking the model from the Libraries Browser and choosing Simulation Setup.

29.3.1 TranslationFlag Tab

From the translationFlag tab, do the following,

- check the Enable dataReconciliation checkbox.

29.3.2 SimulationFlag Tab

From the SimulationFlag tab, do the following,

- check the DataReconciliation Algorithm for Constrained Equation checkbox.
- load the input file with dataReconciliation inputs, only csv file is accepted.
- fill in the Epsilon value (e.g) 0.001

And finally press the ok button to start the dataReconciliation procedure

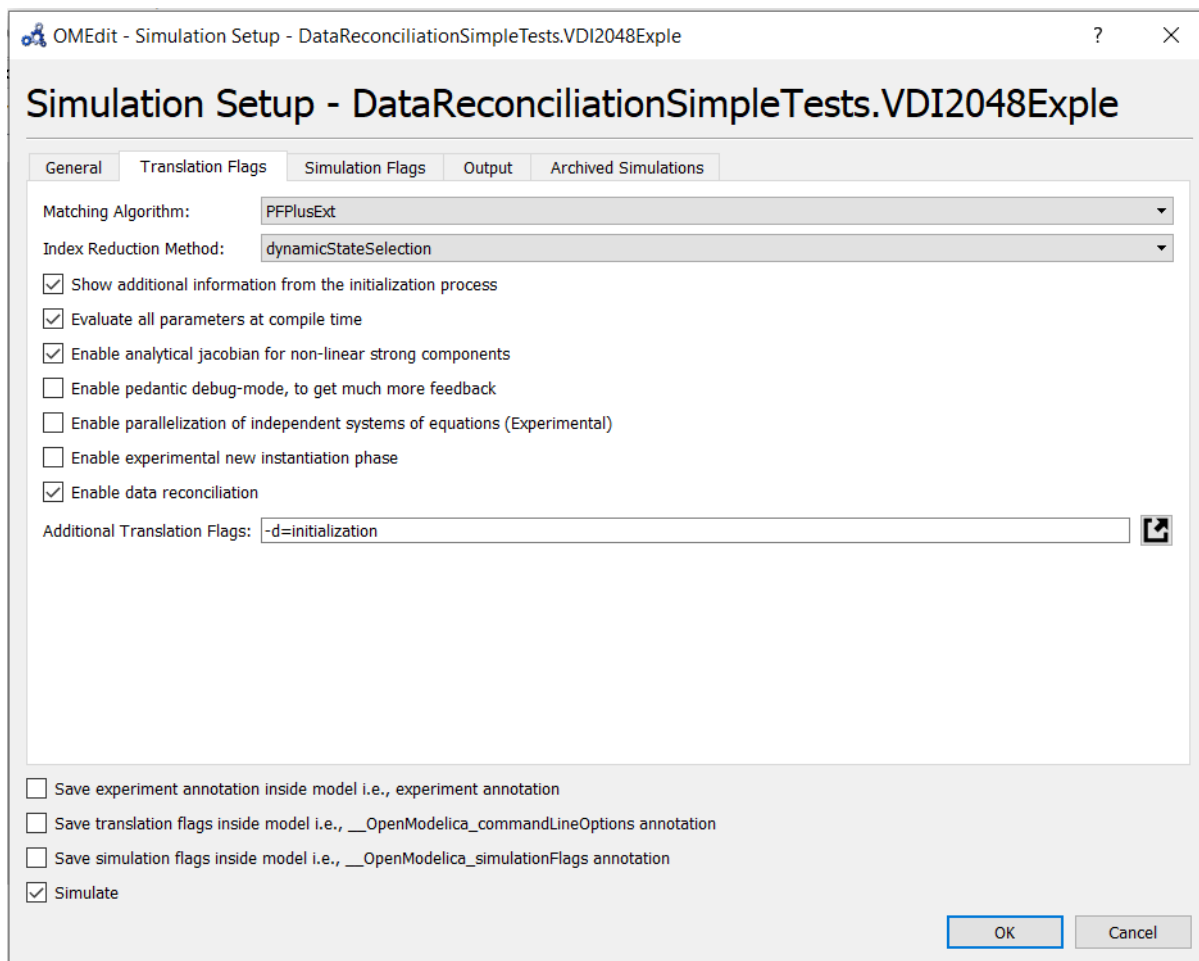

Figure 29.2: Setting DataReconciliation TraslationFlag

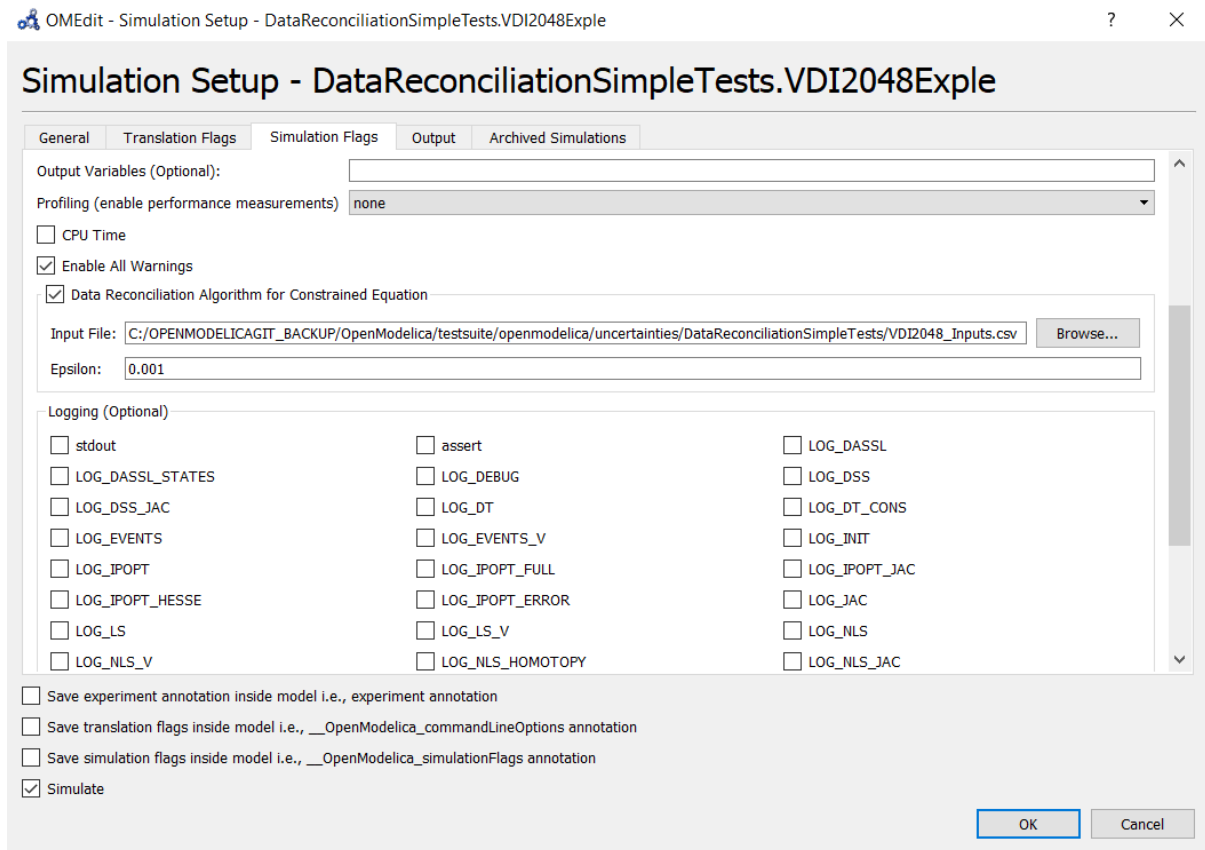

Figure 29.3: Setting DataReconciliation SimulationFlag

29.3.3 Generating the InputFile and Running the DataReconciliation

Generating an empty csv file with variable names makes it easy for the users to fill in the datas, so that ordering of variables and names are not mismatched. This is an important step as variable ordering should match with the jacobian columns generated for dataReconciliation procedure. The input file is named as “modelname_Inputs.csv” which is generated in the current working directory of the model. This step shall be done for the first time and the next time when running the dataReconciliation for the same model, we can directly set the input file and run the DataReconciliation procedure.

This is done in 2 steps.

- Setting the TranslationFlag defined in *TranslationFlag Tab*. and press the Ok button.

And then from the plotting window variable browser, right click on the model and select the “re-simulate Setup” as shown below

Which opens the simulation set-up dialog window and select the simulation Flag tab defined in *SimulationFlag Tab*. and load the csv file and fill in the epsilon value and press the “Ok” button to start the Data Reconciliation Procedure.

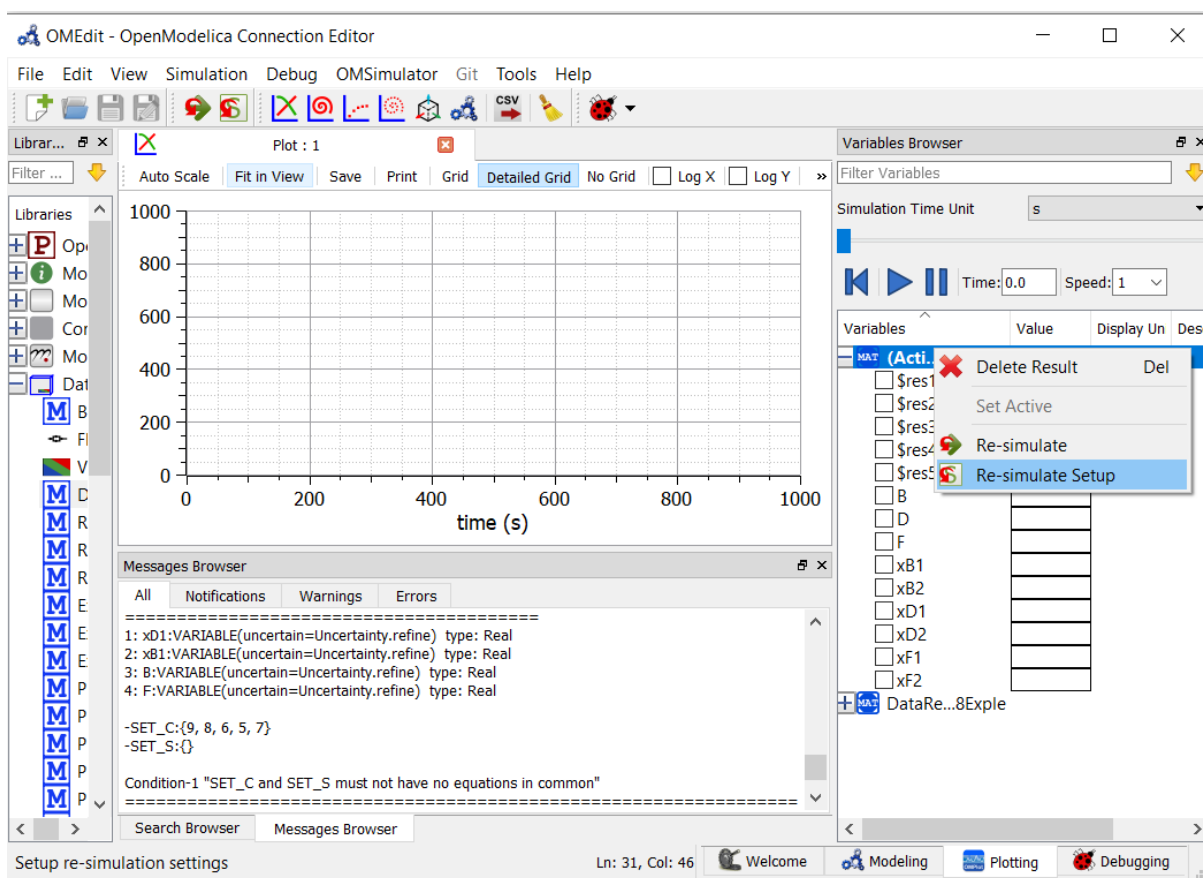

Figure 29.4: Select the re-simulate setup

29.4 DataReconciliation Results

After the Data Reconciliation procedure is completed, the results are generated in the working directory. The default working directory in OMEdit is set to local temp directory of the operating system. The users can change the working directory of OMEdit by, Tools > Options > General > WorkingDirectory

A separate working directory is created in the working directory. The directory is named based on the modelName and the result files are stored in that directory. Two result files are generated namely.

- HTML Report.
- CSV file

An Example of Result directory is given below,

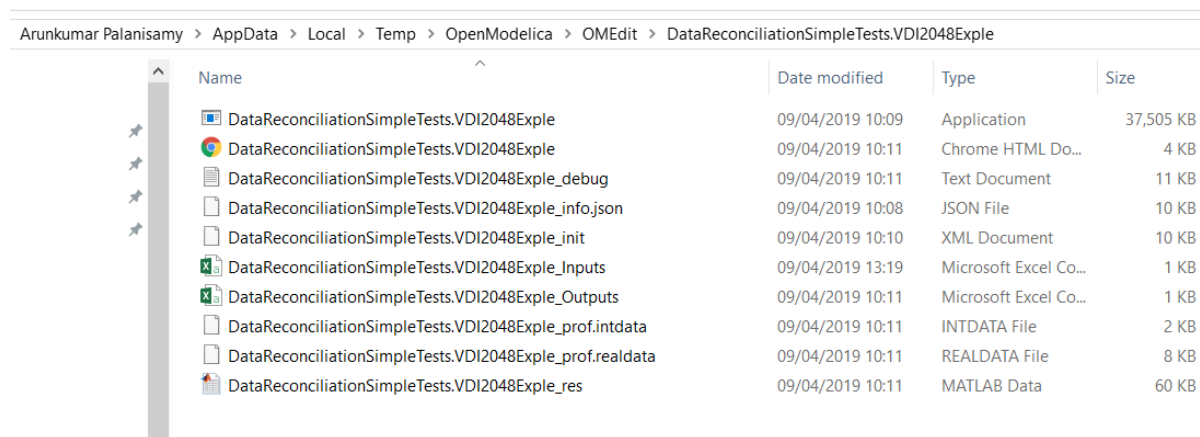

Name	Date modified	Type	Size
DataReconciliationSimpleTests.VDI2048Exple	09/04/2019 10:09	Application	37,505 KB
DataReconciliationSimpleTests.VDI2048Exple	09/04/2019 10:11	Chrome HTML Do...	4 KB
DataReconciliationSimpleTests.VDI2048Exple_debug	09/04/2019 10:11	Text Document	11 KB
DataReconciliationSimpleTests.VDI2048Exple_info.json	09/04/2019 10:08	JSON File	10 KB
DataReconciliationSimpleTests.VDI2048Exple_init	09/04/2019 10:10	XML Document	10 KB
DataReconciliationSimpleTests.VDI2048Exple_Inputs	09/04/2019 13:19	Microsoft Excel Co...	1 KB
DataReconciliationSimpleTests.VDI2048Exple_Outputs	09/04/2019 10:11	Microsoft Excel Co...	1 KB
DataReconciliationSimpleTests.VDI2048Exple_prof.intdata	09/04/2019 10:11	INTDATA File	2 KB
DataReconciliationSimpleTests.VDI2048Exple_prof.realdata	09/04/2019 10:11	REALDATA File	8 KB
DataReconciliationSimpleTests.VDI2048Exple_res	09/04/2019 10:11	MATLAB Data	60 KB

Figure 29.5: Result Directory Structure

29.4.1 HTML Report

The html report is named with modelName.html. The Html report contains 3 section namely 1. Overview 2. Analysis and 3. Results

The Overview section provides the general details of the model such as Modelicafile, ModelName, ModelDirectory, InputFiles and Generated Date and Time of the Report. The Analysis section provides information about the data Reconciliation procedure such as Number of Extracted equations in setC, Number of variable to be Reconciled which are Variable of interest, Number of Iterations to Converge, Final Converged Value ,Epsilon value provided by the users and Results of Global test.

The Results section provides the numerical values computed by the data Reconciliation algorithm. The table contains 8 columns namely,

1. Variables to be Reconciled – names of the Uncertainty variables, given in the modelica model
2. Initial Measured Values – numerical values given by the users
3. Reconciled Values – Calculated values according to Data Reconciliation Procedure.
4. Initial Uncertainty Values – Half Width confidence interval provides by the users, which is later used to compute the Covariance Matrix S_x .
5. Reconciled Uncertainty Values – Calculated Values according to Data Reconciliation Procedure.
6. Results of Local Tests – Calculated values according to Data Reconciliation Procedure
7. Values of Local Tests – Calculated values according to Data Reconciliation Procedure
8. Margin to correctness – Calculated values according to Data Reconciliation Procedure

A sample HTML Report generated for Splitter1.mo model is presented below.

DataReconciliation Report

Overview:

ModelFile: DataReconciliationSimpleTests.Splitter1.mo
ModelName: DataReconciliationSimpleTests.Splitter1
ModelDirectory: C:/OPENMODELICAGIT/OpenModelica/testsuite/openmodelica/uncertainties/DataReconciliationSimpleTests
Measurement Files: C:/OPENMODELICAGIT_BACKUP/OpenModelica/testsuite/openmodelica/uncertainties/DataReconciliationSimpleTests/Splitter1Inputs.csv
Generated: Wed Apr 10 12:08:45 2019 by **OpenModelica-v1.14.0-dev-225-g199705757 (64-bit)**

Analysis:

Number of Extracted equations: 1
Number of Variables to be Reconciled: 3
Number of Iteration to Converge: 2
Final Converged Value(J*/r) : 0
Epsilon : 0.001
Final Value of the objective Function (J*) : 0
Chi-square value : 3.84146
Result of Global Test : TRUE

Results:

Variables to be Reconciled	Initial Measured Values	Reconciled Values	Initial Uncertainty Values	Reconciled Uncertainty Values	Results of Local Tests	Values of Local Tests	Margin to Correctness(distance from 1.96)
Q1	12	10.6667	2	1.1547	TRUE	1.60033	0.359667
Q2	5	5.33333	1	0.912871	TRUE	1.60033	0.359667
Q3	5	5.33333	1	0.912871	TRUE	1.60033	0.359667

Figure 29.6: HTML Report

29.4.2 Csv file

Along with the Html Report, an output csv file is also generated which mainly contains the Results section of the HTML report in a csv format. The csv file is named with modelname_Outputs.csv. An example output csv file is presented below.

	A	B	C	D	E	F	G	H
1	Variables to be Reconciled	Initial Measured Values	Reconciled Values	Initial Uncertainty	Reconciled Uncertainty	Results of Local	Values of Local Tests	Margin to Correctness(distance from 1.96)
2	Q1	12	10.6667	2	1.1547	TRUE	1.60033	0.359667
3	Q2	5	5.33333	1	0.912871	TRUE	1.60033	0.359667
4	Q3	5	5.33333	1	0.912871	TRUE	1.60033	0.359667

Figure 29.7: Output Csv file

29.4.3 Logging and Debugging

All the Computations of data Reconciliation procedure are logged into log file. The log file is named as modelname_debug.log. For Detailed Debugging the flag LOG_JAC checkbox can be checked see [SimulationFlag Tab](#).

FREQUENTLY ASKED QUESTIONS (FAQ)

Below are some frequently asked questions in three areas, with associated answers.

30.1 OpenModelica General

- **Q: OpenModelica does not read the MODELICAPATH environment variable**, even though this is part of the Modelica Language Specification.
- **A: Use the OPENMODELICALIBRARY environment variable instead.** We have temporarily switched to this variable, in order not to interfere with other Modelica tools which might be installed on the same system. In the future, we might switch to a solution with a settings file, that also allows the user to turn on the MODELICAPATH functionality if desired.
- **Q: How do I enter multi-line models into OMShell since it evaluates** when typing the Enter/Return key?
- **A: There are basically three methods: 1) load the model from a file** using the pull-down menu or the loadModel command. 2) Enter the model/function as one (possibly long) line. 3) Type in the model in another editor, where using multiple lines is no problem, and copy/paste the model into OMShell as one operation, then push Enter. Another option is to use OMNotebook instead to enter and evaluate models.

30.2 OMNotebook

- **Q: OMNotebook hangs, what to do?**
- **A: It is probably waiting for the omc.exe (compiler) process.** (Under windows): Kill the processes omc.exe, g++.exe (C-compiler), as.exe (assembler), if present. If OMNotebook then asks whether to restart OMC, answer yes. If not, kill the process OMNotebook.exe and restart manually.
- **Q: After a previous session, when starting OMNotebook again, I get a strange message.**
- **A: You probably quit the previous OpenModelica session in the wrong way**, which left the process omc.exe running. Kill that process, and try starting OMNotebook again.
- **Q: I copy and paste a graphic figure from Word or some other application** into OMNotebook, but the graphic does not appear. What is wrong?
- **A: OMNotebook supports the graphic picture formats supported by Qt 4**, including the .png, .bmp (bitmap) formats, but not for example the gif format. Try to convert your picture into one of the supported formats, (e.g. in Word, first do paste as bitmap format), and then copy the converted version into a text cell in OMNotebook.
- **Q: I select a cell, copy it (e.g. Ctrl-C), and try to paste it at** another place in the notebook. However, this does not work. Instead some other text that I earlier put on the clipboard is pasted into the nearest text cell.
- **A: The problem is wrong choice of cursor mode, which can be text insertion or cell insertion.** If you click inside a cell, the cursor become vertical, and OMNotebook expects you to paste text inside

the cell. To paste a cell, you must be in cell insertion mode, i.e., click between two cells (or after a cell), you will get a vertical line. Place the cursor carefully on that vertical line until you see a small horizontal cursor. Then you should past the cell.

- **Q: I am trying to click in cells to place the vertical character** cursor, but it does not seem to react.
- **A: This seems to be a Qt feature. You have probably made a selection** (e.g. for copying) in the output section of an evaluation cell. This seems to block cursor position. Click again in the output section to disable the selection. After that it will work normally.
- **Q: I have copied a text cell and start writing at the beginning of** the cell. Strangely enough, the font becomes much smaller than it should be.
- **A: This seems to be a Qt feature. Keep some of the old text and start** writing the new stuff inside the text, i.e., at least one character position to the right. Afterwards, delete the old text at the beginning of the cell.

30.3 OMDev - OpenModelica Development Environment

- **Q: I get problems compiling and linking some files when using OMDev** with the MINGW (Gnu) C compiler under Windows.
- **A: You probably have some Logitech software installed. There is a** known bug/incompatibility in Logitech products. For example, if lvprcsrv.exe is running, kill it and/or prevent it to start again at reboot; it does not do anything really useful, not needed for operation of web cameras or mice.

MAJOR OPENMODELICA RELEASES

This Appendix lists the most important OpenModelica releases and a brief description of their contents. Right now versions from 1.3.1 to 1.16.0 are described.

31.1 Release Notes for OpenModelica 1.16.0

31.1.1 OpenModelica Compiler (OMC)

The new frontend has been further improved, with enhanced support of records and arrays. 33 tickets were fixed since the previous 1.14.0 release. The new front-end can now handle 100% of the Modelica Standard Library 3.2.3 models.

Improvements to the back-end: - new minimal tearing option to disable tearing except for discrete variables - improved symbolic Jacobian evaluation option reuses constant part of the Jacobian - improvements to dynamic state selection and common subexpression elimination - new ASCC algorithm replaces and improves resolveLoops algorithm, allowing to detect high-index problems with indirect structural state constraints, e.g. in three-phase AC circuits - homotopy operator now used on first try by default - linearized model export also available in Matlab, Python, and Julia with option

Improvements to code generation and runtime:

- Better support for models with records - CVODE solver from SUNDIALS

added; – 2 methods available: BDF (stiff) and Adams-Moulton (non-stiff)

It is now possible to build a version of OMC with parallel Jacobian evaluation using OpenMP

```
`` - On Windows build OMC with``  
`` \ \ ``.  
`` - On Unix configure with \ \ `` and build OMC.  
`` - Only DASSL and IDA can use parallelized symbolic Jacobians.``  
`` - Simulate with \ \ `` or set environment  
`` variable \ \ `` to use a specific number of  
`` threads. Otherwise all available threads will be used.``
```

31.1.2 Graphic Editor OMEdit

Replaceable classes now have graphical support in OMEdit. This feature was planned to be included in release 1.15.0, but it eventually turned out to be more convenient to merge it in the 1.16.0 release. Support for replaceable elements in OMEdit is currently limited to redeclare statements without parameter modifiers. This is enough to handle Modelica.Media medium models in Modelica.Fluid components. Please note that **this feature is currently optional and needs to be activated** by setting Tools|Options|General|Enable replaceable support in OMEdit.

Over 50 bug fixes were made to OMEdit to increase usability of the GUI.

OMSimulator GUI improved: text editing of SSP models, undo/redo, delete components, etc.

31.1.3 FMI Support

Many FMI export bug fixes and improvements to increase usability of OMC-generated FMUs.

FMI/CS 2.0 now includes CVODE solvers (previously only fixed-step forward Euler) and customization via simulation flags.

31.1.4 Other things

Successful integration of Modelon's license manager for encrypted libraries. A special version of OMC available to Consortium members can now handle encrypted libraries, preventing source code browsing, and license management, via Modelon's license manager, embedded in the encrypted library.

Improved Modelica package management. The annotation is now fully supported, which means for example that OpenModelica will automatically use the Modelica Standard Library 3.2.3 even for libraries that have a uses annotation pointing to earlier MSL versions, e.g. 3.2.2 or 3.2.1, because the annotations in the MSL specify that 3.2.3 can be used instead of 3.2.2 or 3.2.1 without any conversion script, i.e., it is fully backwards compatible. A full-fledged [Modelica package manager](#) is also included in OpenModelica 1.16.0, currently only with a command line interface; integration in the GUI is planned for the next 1.17.0 release, together with conversion scripts.

31.1.5 List of tickets closed in 1.16.0

`-,col=changelog,group=component,format=table)`

31.2 Release Notes for OpenModelica 1.15.0

Release 1.15.0 was initially planned to add graphical support of replaceable classes in OMEdit to 1.14.0. The development took more time than expected. Back-porting it to 1.14.0 turned out to be unnecessarily difficult and time-consuming. Hence, we decided to cancel 1.15.0 and to release the support of replaceable classes in 1.16.0.

31.3 Release Notes for OpenModelica 1.14.0

31.3.1 OpenModelica Compiler (OMC)

The most dramatic enhancement of the OpenModelica Compiler is the New Frontend, which on the average gives a factor of 10-20 speed improvement in the flattening phase of compilation. The new frontend is default in this release, but a feature is implemented that allows the user to switch to the old frontend if problems appear for a specific model. The speed of the OMEdit GUI has only slightly increased in this version, since it is still dependent mostly on the old frontend. Further GUI speed increases are available in the coming OpenModelica.1.15.0. About 200 issues have been fixed, including enhancements, compared to the previous 1.13.2 release. The bug fixes are on trac.

OpenModelica Compiler New Frontend news: • Implementation of expandable connectors completed, a rather large piece of work. • A number of smaller enhancements and fixes • The New Frontend (NF) gives slightly

better simulation coverage on MSL 3.2.3 than the Old Frontend • The New Frontend is on the average about 20 times faster on flattening. • Remaining work is mainly on further bug fixing and testing the new frontend for all other libraries, as well as more work on modifiers of arrays in conjunction with non-expanded arrays. (The array modifiers have now been implemented in 1.16.0 but not yet in 1.14.0 in order to not delay the 1.14.0 release)

31.3.2 Graphic Editor OMEdit

- Drag and drop for the text layer.
- Auto completion of class names, components and annotations.
- GUI for data reconciliation – a method for increasing sensor data precision
- Improved duplication functionality for copying classes.
- Better handling of Compiler flags.
- Partly completed: annotations for dynamic icon update.
- Support for connectorSizing annotation
- Several bug fixes. You can find the list here.
- Docs: <https://openmodelica.org/doc/OpenModelicaUsersGuide/latest/omedit.html>
- Auto-complete annotations.
- Support for Icon/Diagram map annotation
- Copy paste functionality
- Reset OMEdit settings/options.
- Array plots update on re-simulation
- Support for connectorSizing annotation.
- Drag and drop class names to text layer in OMEdit
- OMPlot: Improved plotting e.g., top and bottom margins for better view, snap to curve etc.
- GUI support for replaceable libraries is being tested in a separate branch and will be made available in the coming 1.15.0 release.

31.3.3 OMC backend and run-time system

- A new more efficient and correct implementation of arrays and records.
- The FMI OMSimulator API calls are now also available in the OMC API functions, e.g. for use from OMNotebook, Jupyter notebooks.

Backend new features

- Added possibility to generate analytic Jacobians for linear strong components

```
`` * -Use flag LSanalyticJacobian to enable analytical Jacobian for linear loops. Default false.``
```

- Added output language options for linearization: matlab, python, julia.
- Available with `--linearizationDumpLanguage=modelica/matlab/python/julia`. Default is modelica.

Backend enhancements

- Unified Jacobian evaluation from DASSL and IDA integrators
- Added result check for linear solvers Lis, Klu, Total Pivot and Umfpack if a residual function is available.
- Improved debug dumping

```
`` * -d=bltdump (Index reduction information)``
`` * -d=initialization``
`` * -d=dumpLoops``
```

- Improved warning for iteration variables:

```
`` * Only warn about non-linear iteration variables with default start attribute.``
`` * Other variables have no influence on simulation at all.``
```

- Build instructions for OpenModelica on Windows Subsystem for Linux

Improved Jacobian evaluation with translation flag `-d=symJacConstantSplit` (requires `--generateSymbolicJacobian`) Generate Jacobians with separated constant part to split equations that are independent of the seed vector. These equations only need to be evaluated only once per Jacobian evaluation.

Backend bugfixes

- Homotopy: Use simplified version only during initialization to avoid errors during matching and differentiation.
- Logging for Homotopy path fixed so log can be loaded in OMEdit.
- Support general function call differentiation for equations in residual form.
- Equations in residual form don't fail during index reduction any more.

31.3.4 FMI Support

Bug fixes to FMI export, see below

31.3.5 Other things

`-,col=changelog,group=component,format=table)`

31.4 Release Notes for OpenModelica 1.13.0

- OMSimulator 2.0 – the second release of our efficient FMI Simulation tool including a GUI for FMI Composition, co-simulation and model-exchange simulation, and SSP standard support.
- Model and library encryption/decryption support. (Only for usage by OSMC member organizations)
- Improved OpenModelica DAEMode for efficient solution of large Modelica models.
- Julia scripting API to OpenModelica.
- Basic Matlab scripting API to OpenModelica.
- OMSysIdent - parameter estimation module for linear and non-linear parametric dynamic models.
- Interactive simulation and control of simulations with OPC-UA.
- PDEModelica1 - experimental support for one-dimensional PDEs in Modelica.
- Analytic directional derivatives for FMI export and efficient calculation of multiple Jacobian columns – giving much faster simulation for some models
- Enhanced OMEdit – including fast multi-file search.
- Improved error messages and stability.
- A version of the new fast compiler frontend available for testing, can be enabled by a flag Currently (December 10), simulates about 84% of MSL 3.2.2

Note: the replaceable GUI support has been moved to OpenModelica 1.14.0 and will be available in nightly builds.

`-,col=changelog,group=component,format=table)`

31.5 Release Notes for OpenModelica 1.12.0

- A new (stand-alone) FMI- and TLM-based simulation tool OMSimulator, first version for connected FMUs, TLM objects, Simulink models (via wrappers), Adams models (via wrappers), BEAST models (via wrappers), Modelica models
- Graphic configuration editing of composite models consisting of FMUs
- Basic graphical editing support for state machines and transitions
- Faster lookup processing, making some libraries faster to browse and compile
- Additional advanced visualization features for multibody animation
- Increased library coverage including significantly increased verification coverage
- Increased tool interoperability by addition of the ZeroMQ communications protocol
- Further enhanced OMPython including linearization, now also working with Python 3
- Support for RedHat/Fedora binary builds of OpenModelica

31.5.1 OpenModelica Compiler (OMC)

- Faster lookup processing
- Initializing external objects together with parameters
- Handle exceptions in numeric solvers
- Support for higher-index discrete clock partitions
- Improved unit checking
- Improved initialization of start values
- Decreased compilation time of models with large size arrays
- New approach for homotopy-based initialization (still experimental)
- A bunch of fixes: Bugs, regressions, performance issues
- Improved Dynamic Tearing by adding constraints for the casual set
- Improved module wrapFunctionCalls with one-time evaluation of Constant CSE-variables
- Added initOptModule for inlineHomotopy
- Added configuration flag tearingStrictness to influence solvability
- New methods for inline integration for continuous equations in clocked partitions, now covering: ExplicitEuler, ImplicitEuler, SemiImplicitEuler and ImplicitTrapezoid
- Complete implementation of synchronous features in C++ runtime
- Refactored linear solver of C++ runtime
- Improved Modelica_synchronous_cpp coverage
- New common linear solver module, optionally sparse, for the C++ runtime
- Coverage of most of the OpenHydraulics library
- Improved coverage of ThermoSysPro, IdealizedContact and Chemical libraries
- Support of time events for cpp-simulation and enabled time events in cpp-FMUs
- Global homotopy method for initialization
- Scripting API to compute accumulated errors (1-norm, 2-norm, max. error) of 2 time series

31.5.2 Graphic Editor OMEdit

- Additional advanced visualization features for multibody animation (transparency, textures, change colours by dialog)
- An HTML WYSIWYG Editor, e.g. useful for documentation
- Support for choices(checkBox=true) annotation.
- Support for loadSelector & saveSelector attribute of Dialog annotation.
- Panning of icon/diagram view and plot window.
- AutoComplete feature in text editing for keywords, types, common Modelica constructs
- Follow connector transformation from Diagram View to Icon View.
- Further stability improvements
- Improved performance for rendering some icons using the interactive API
- Improved handling of parameters that cannot be evaluated in Icon annotations
- Basic graphic editing support for state machines and transitions (not yet support for showing state internals on diagram layer)
- Interactive state manipulation for FMU-based animations

31.5.3 FMI Support

- A new (stand-alone) FMI- and TLM-based simulation tool OMSimulator, first version (a main deliverable of the OPENCPS project, significant contributions and code donations from SKF)
- Graphic configuration editing of composite models consisting of FMUs
- Co-simulation/simulation of connected FMUs, TLM objects, Simulink models (via wrappers), Adams models (via wrappers), BEAST models (via wrappers), Modelica models.

31.5.4 Other things

- Increased OpenModelica tool interoperability by adding the ZeroMQ communications protocol in addition to the previously available Corba. This also enables Python 3 usage in OMPython on all platforms.
- Textual support through the OpenModelica API and graphical support in OMEdit for generation of single or multiple requirement verification scenarios
- VVDRlib – a small library for connecting requirements and models together, with notions for mediators, scenarios, design alternatives
- Further enhanced OMPython including linearization, now also working with Python 3.”
- Jupyter notebooks also supported with OMPython and Python 3
- New enhanced library testing script (libraries.openmodelica.org/branches).
- Addition of mutable reference data types in MetaModelica
- Support for RedHat/Fedora binary builds of OpenModelica
- Support for exporting the system of equations in GraphML (yEd) format for debugging

-,col=changelog,group=component,format=table)

31.6 Release Notes for OpenModelica 1.11.0

- Dramatically improved compilation speed and performance, in particular for large models.
- 3D animation visualization of regular MSL MultiBody simulations and for real-time FMUs.
- Better support for synchronous and state machine language elements, now supports 90% of the clocked synchronous library.
- Several OMEdit improvements including folding of large annotations.
- 64-bit OM on Windows further stabilized
- An updated OMDev (OpenModelica Development Environment), involving msys2. This was needed for the shift to 64-bit on Windows.
- Integration of Sundials/IDA DAE solver with potentially large increase of simulation performance for large models with sparse structure.
- Improved library coverage.
- Parameter sensitivity analysis added to OMC.

31.6.1 OpenModelica Compiler (OMC)

- Real-time synchronization support by using `simFlag -rt=1.0` (or some other time scaling factor).
- A prototype implementation of OPC UA using an [open source OPC UA implementation](#). The old OPC implementation was not maintained and relied on a Windows-only proprietary OPC DA+UA package. (At the moment, OPC is experimental and lacks documentation; it only handles reading/writing Real/Boolean input/state variables. It is planned for OMEdit to use OPC UA to re-implement interactive simulations and plotting.)
- Dramatically improved compilation speed and dramatically reduced memory requirements for very large models. In Nov 2015, the largest power generation and transmission system model that OMC could handle had 60000 equations and it took 700 seconds to generate the simulation executable code; it now takes only 45 seconds to do so with OMC 1.11.0, which can also handle a model 10 times bigger (600 000 equations) in less than 15 minutes and with less than 32 GB of RAM. Simulation times are comparable to domain-specific simulation tools. See for example [ScalableTestSuite](#) for some of the improvements.
- Improved library coverage
- Better support for synchronous and state machine language elements, now simulates 90% of the clocked synchronous library.
- Enhanced Cpp runtime to support the PowerSystems library.
- Integration of Sundials/IDA solver as an alternative to DASSL.
- A DAEMode solver mode was added, which allows to use the sparse IDA solver to handle the DAEs directly. This can lead to substantially faster simulation on large systems with sparse structure, compared to the traditional approach.
- The direct sparse solvers KLU and SuperLU have been added, with benefits for models with large algebraic loops.
- Multi-parameter sensitivity analysis added to OMC.
- Progress on more efficient inline function mechanism.
- Stabilized 64-bit Windows support.
- Performance improvement of parameter evaluation.
- Enhanced tearing support, with prefer iteration variables and user-defined tearing.
- Support for external object aliases in connectors and equations (a non-standard Modelica extension).
- Code generation directly to file (saves maximum memory used). #3356
- Code generation in parallel is enabled since #3356 (controlled by omc flag ``-n``). This improves performance since generating code directly to file avoid memory allocation.
- Allowing mixed dense and sparse linear solvers in the generated simulation (chosen depending on simflags ``-ls`` (dense solver), ``-lss`` (sparse solver), ``-lssMaxDensity`` and ``-lssMinSize``).

31.6.2 Graphic Editor OMEdit

- Significantly faster browsing of most libraries.
- Several GUI improvements including folding of multi-line annotations.
- Further improved code formatting preservation during edits.
- Support for all simulation logging flags.
- Select and export variables after simulation.
- Support for [Byte Order Mark](#). Added support enables other tools to correctly read the files written by OMEdit.
- Save files with line endings according to OS (Windows (CRLF), Unix (LF)).

- Added OMEdit support for FMU cross compilation. This makes it possible to launch OMEdit on a remote or virtual Linux machine using a Windows X server and export an FMU with Windows binaries.
- Support of DisplayUnit and unit conversion.
- Fixed automatic save.
- Initial support for DynamicSelect in model diagrams (texts and visible attribute after simulation, no expressions yet).
- An HTML documentation editor (not WYSIWYG; that editor will be available in the subsequent release).
- Improved logging in OMEdit of structured messages and standard output streams for simulations.

31.6.3 FMI Support

- Cross compilation of C++ FMU export. Compared to the C runtime, the C++ cross compilation covers the whole runtime for model exchange.
- Improved Newton solver for C++ FMUs (scaling and step size control).

31.6.4 Other things

- 3D animation visualization of regular MSL MultiBody simulations and for real-time FMUs.
- An updated OMDev (OpenModelica Development Environment), involving msys2. This was needed for the shift to 64-bit on Windows.
- [OMWebbook](#), a web version of OMNotebook online. Also, a script is available to convert an OMNotebook to an OMWebbook.
- A Jupyter notebook Modelica mode, available in OpenModelica.

1.11.0,status=closed,severity!=trivial,resolution=fixe!-,col=changelog,group=component,format=table)

31.7 Release Notes for OpenModelica 1.10.0

The most important enhancements in the OpenModelica 1.10.0 release:

31.7.1 OpenModelica Compiler (OMC)

New features:

- Real-time synchronization support by using `simFlag -rt=1.0` (or some other time scaling factor). - A prototype implementation of OPC UA using an [open source OPC UA implementation](#). The old OPC implementation was not maintained and relied on a Windows-only proprietary OPC DA+UA package. (At the moment, OPC is experimental and lacks documentation; it only handles reading/writing Real/Boolean input/state variables. It is planned for OMEdit to use OPC UA to re-implement interactive simulations and plotting.)

Performance enhancements:

- Code generation directly to file (saves maximum memory used). #3356 -

Code generation in parallel enabled since #3356 allows this without allocating too much memory (controlled by `omc flag -n`). - Various scalability enhancements, allowing the compiler to handle hundreds of thousands of equations. See for example [ScalableTestSuite](#) for some of the improvements. - Better defaults for handling tearing (OMC flags `--maxSizeLinearTearing`` and `--maxSizeNonlinearTearing``). - Allowing mixed dense and sparse linear solvers in the generated simulation (chosen depending on `simflags -ls`` (dense solver), `-lss`` (sparse solver), `-lssMaxDensity`` and `-lssMinSize``).

31.7.2 Graphic Editor OMEdit

31.7.3 OpenModelica Notebook (OMNotebook)

31.7.4 Optimization

31.7.5 FMI Support

31.7.6 OpenModelica Development Environment (OMDev)

31.8 Release Notes for OpenModelica 1.9.4

OpenModelica v1.9.4 was released 2016-03-09. These notes cover the v1.9.4 release and its subsequent bug-fix releases (now up to 1.9.7).

31.8.1 OpenModelica Compiler (OMC)

- Improved simulation speed for many models. simulation speed went up for 80% of the models. The compiler frontend became faster for almost all models, average about 40% faster.
- Initial support for synchronous models with clocked equations as defined in the Modelica 3.3 standard
- Support for homotopy operator

31.8.2 Graphic Editor OMEdit

- Undo/Redo support.
- Preserving text formatting, including indentation and whitespace. This is especially important for diff/merge with several collaborating developers possibly using several different Modelica tools.
- Better support for inherited classes.
- Allow simulating models using visual studio compiler.
- Support for saving Modelica package in a folder structure.
- Allow reordering of classes inside a package.
- Highlight matching parentheses in text view.
- When copying the text retain the text highlighting and formatting.
- Support for global head definition in the documentation by using ``__OpenModelica_infoHeader`` annotation.
- Support for expandable connectors.
- Support for uses annotation.

31.8.3 FMI Support

- Full FMI 2.0 co-simulation support now available
- Upgrade Cpp runtime from C++03 to C++11 standard, minimizing external link dependencies. Exported FMUs don't depend on additional libraries such as boost anymore
- FMI 2.0 is broken for some models in 1.9.4. Upgrading to 1.9.6 is advised.

31.9 Release Notes for OpenModelica 1.9.3

The most important enhancements in the OpenModelica 1.9.3 release:

- Enhanced collaborative development and testing of OpenModelica by moving to the GIT-hub framework for versioning and parallel development.
- More accessible and up-to-date automatically generated documentation provided in both [html](#) and [pdf](#).
- Further improved simulation speed and coverage of several libraries.
- OMEdit graphic connection editor improvements.
- OMNotebook improvements.

31.9.1 OpenModelica Compiler (OMC)

This release mainly includes improvements of the OpenModelica Compiler (OMC), including, but not restricted to the following:

- Further improved simulation speed and coverage for several libraries.
- Faster generated code for functions involving arrays, factor 2 speedup for many power generation models.
- Better initialization.
- An implicit inline Euler solver available.
- Code generation to enable vectorization of for-loops.
- Improved non-linear, linear and mixed system solving.
- Cross-compilation for the ARMhf architecture.
- A prototype state machine implementation.
- Improved performance and stability of the C++ runtime option.
- More accessible and up-to-date automatically generated documentation provided in both [html](#) and [.pdf](#).

31.9.2 Graphic Editor OMEdit

There are several improvements to the OpenModelica graphic connection editor OMEdit:

- Support for uses annotations.
- Support for declaring components as vectors.
- Faster messages browser with clickable error messages.
- Support for managing the stacking order of graphical shapes.
- Several improvements to the plot tool and text editor in OMEdit.

31.9.3 OpenModelica Notebook (OMNotebook)

Several improvements:

- Support for moving cells from one place to another in a notebook.
- A button for evaluation of whole notebooks.
- A new cell type called Latex cells, supporting Latex formatted input that provides mathematical typesetting of formulae when evaluated.

31.9.4 Optimization

Several improvements of the Dynamic Optimization module with collocation, using Ipopt:

- Better performance due to smart treatment of algebraic loops for optimization.
- Improved formulation of optimization problems with an annotation approach which also allows graphical problem formulation.
- Proper handling of constraints at final time.

31.9.5 FMI Support

Further improved FMI 2.0 co-simulation support.

31.9.6 OpenModelica Development Environment (OMDev)

A big change: version handling and parallel development has been improved by moving from SVN to GitHub. This makes it easier for each developer to test his/her fixes and enhancements before committing the code. Automatic mirroring of all code is still performed to the OpenModelica SVN site.

31.10 Release Notes for OpenModelica 1.9.2

The OpenModelica 1.9.2 Beta release is available now, January 31, 2015. Please try it and give feedback! The final release is planned within 1-2 weeks after some more testing. The most important enhancements in the OpenModelica 1.9.2 release:

- The OpenModelica compiler has moved to a new development and release platform: the bootstrapped OpenModelica compiler. This gives advantages in terms of better programmability, maintenance, debugging, modularity and current/future performance increases.
- The OpenModelica graphic connection editor OMEdit has become 3-5 times faster due to faster communication with the OpenModelica compiler linked as a DLL. This was made possible by moving to the bootstrapped compiler.
- Further improved simulation coverage for a number of libraries.
- OMEdit graphic connection editor improvements

31.10.1 OpenModelica Compiler (OMC)

This release mainly includes improvements of the OpenModelica Compiler (OMC), including, but not restricted to the following:

- The OpenModelica compiler has moved to a new development and release platform: the bootstrapped OpenModelica compiler. This gives advantages in terms of better programmability, maintenance, debugging, modularity and current/future performance increases.
- Further improved simulation coverage for a number of libraries compared to 1.9.1. For example:
 - MSL 3.2.1 100% compilation, 97% simulation (3% increase)
 - MSL Trunk 99% compilation (1% increase), 93% simulation (3% increase)
 - ModelicaTest 3.2.1 99% compilation (2% increase), 95% simulation (6% increase)
 - ThermoSysPro 100% compilation, 80% simulation (17% increase)
 - ThermoPower 97% compilation (5% increase), 85% simulation (5% increase)
 - Buildings 80% compilation (1% increase), 73% simulation (1% increase)
- Further enhanced OMC compiler front-end coverage, scalability, speed and memory.

- Better initialization.
- Improved tearing.
- Improved non-linear, linear and mixed system solving.
- Common subexpression elimination support - drastically increases performance of some models.

31.10.2 Graphic Editor OMEdit

- The OpenModelica graphic connection editor OMEdit has become 3-5 times faster due to faster communication with the OpenModelica compiler linked as a DLL. This was made possible by moving to the bootstrapped compiler.
- Enhanced simulation setup window in OMEdit, which among other things include better support for integration methods and dassl options.
- Support for running multiple simultaneous simulation.
- Improved handling of modifiers.
- Re-simulate with changed options, including history support and re-simulating with previous options possibly edited.
- More user friendly user interface by improved connection line drawing, added snap to grid for icons and conversion of icons from PNG to SVG, and some additional fixes.

31.10.3 Optimization

Some smaller improvements of the Dynamic Optimization module with collocation, using Ipopt.

31.10.4 FMI Support

Further improved for FMI 2.0 model exchange import and export, now compliant according to the FMI compliance tests. FMI 1.0 support has been further improved.

31.11 Release Notes for OpenModelica 1.9.1

The most important enhancements in the OpenModelica 1.9.1 release:

- Improved library support.
- Further enhanced OMC compiler front-end coverage and scalability
- Significant improved simulation support for libraries using Fluid and Media.
- Dynamic model debugger for equation-based models integrated with OMEdit.
- Dynamic algorithm model debugger with OMEdit; including support for MetaModelica when using the bootstrapped compiler.

New features: Dynamic debugger for equation-based models; Dynamic Optimization with collocation built into OpenModelica, performance analyzer integrated with the equation model debugger.

31.11.1 OpenModelica Compiler (OMC)

This release mainly includes improvements of the OpenModelica Compiler (OMC), including, but not restricted to the following:

- Further improved OMC model compiler support for a number of libraries including MSL 3.2.1, ModelicaTest 3.2.1, PetriNet, Buildings, PowerSystems, OpenHydraulics, ThermoPower, and ThermoSysPro.
- Further enhanced OMC compiler front-end coverage, scalability, speed and memory.
- Better coverage of Modelica libraries using Fluid and Media.
- Automatic differentiation of algorithms and functions.
- Improved testing facilities and library coverage reporting.
- Improved model compilation speed by compiling model parts in parallel (bootstrapped compiler).
- Support for running model simulations in a web browser.
- New faster initialization that handles over-determined systems, under-determined systems, or both.
- Compiler back-end partly redesigned for improved scalability and better modularity.
- Better tearing support.
- The first run-time Modelica equation-based model debugger, not available in any other Modelica tool, integrated with OMEdit.
- Enhanced performance profiler integrated with the debugger.
- Improved parallelization prototype with several parallelization strategies, task merging and duplication, shorter critical paths, several scheduling strategies.
- Some support for general solving of mixed systems of equations.
- Better error messages.
- Improved bootstrapped OpenModelica compiler.
- Better handling of array subscripts and dimensions.
- Improved support for reduction functions and operators.
- Better support for partial functions.
- Better support for function tail recursion, which reduces memory usage.
- Partial function evaluation in the back-end to improve solving singular systems.
- Better handling of events/zero crossings.
- Support for colored Jacobians.
- New differentiation package that can handle a much larger number of expressions.
- Support for sparse solvers.
- Better handling of asserts.
- Improved array and matrix support.
- Improved overloaded operators support.
- Improved handling of overconstrained connection graphs.
- Better support for the cardinality operator.
- Parallel compilation of generated code for speeding up compilation.
- Split of model files into several for better compilation scalability.
- Default linear tearing.
- Support for impure functions.
- Better compilation flag documentation.
- Better automatic generation of documentation.

- Better support for calling functions via instance.
- New text template based unparsing for DAE, Absyn, SCode, TaskGraphs, etc.
- Better support for external objects (#2724, reject non-constructor functions returning external objects)
- Improved C++ runtime.
- Improved testing facilities.
- New unit checking implementation.
- Support for model rewriting expressions via rewriting rules in an external file.
- Reject more bad code (r19986, consider records with different components type-incompatible)

31.11.2 OpenModelica Connection Editor (OMEdit)

- Convenient editing of model parameter values and re-simulation without recompilation after parameter changes.
- Improved plotting.
- Better handling of flags/units/resources/crashes.
- Run-time Modelica equation-based model debugger that provides both dynamic run-time debugging and debugging of symbolic transformations.
- Run-time Modelica algorithmic code debugger; also MetaModelica debugger with the bootstrapped Open-Modelica compiler.

31.11.3 OMPython

The interface was changed to version 2.0, which uses one object for each OpenModelica instance you want active. It also features a new and improved parser that returns easier to use datatypes like maps and lists.

31.11.4 Optimization

A builtin integrated Dynamic Optimization module with collocation, using Ipopt, is now available.

31.11.5 FMI Support

Support for FMI 2.0 model exchange import and export has been added. FMI 1.0 support has been further improved.

31.12 Release Notes for OpenModelica 1.9.0

This is the summary description of changes to OpenModelica from 1.8.1 to 1.9.0, released 2013-10-09. This release mainly includes improvements of the OpenModelica Compiler (OMC), including, but not restricted to the following:

31.12.1 OpenModelica Compiler (OMC)

This release mainly includes bug fixes and improvements of the OpenModelica Compiler (OMC), including, but not restricted to the following:

- A more stable and complete OMC model compiler. The 1.9.0 final version simulates many more models than the previous 1.8.1 version and OpenModelica 1.9.0 beta versions.
- Much better simulation support for MSL 3.2.1, now 270 out of 274 example models compile (98%) and 245 (89%) simulate, compared to 30% simulating in the 1.9.0 beta1 release.
- Much better simulation for the ModelicaTest 3.2.1 library, now 401 out of 428 models build (93%) and 364 simulate (85%), compared to 32% in November 2012.
- Better simulation support for several other libraries, e.g. more than twenty examples simulate from ThermoSysPro, and all but one model from PlanarMechanics simulate.
- Improved tearing algorithm for the compiler backend. Tearing is by default used.
- Much faster matching and dynamic state selection algorithms for the compiler backend.
- New index reduction algorithm implementation.
- New default initialization method that symbolically solves the initialization problem much faster and more accurately. This is the first version that in general initialize hybrid models correctly.
- Better class loading from files. The package.order file is now respected and the file structure is more thoroughly examined (#1764).
- It is now possible to translate the error messages in the omc kernel (#1767).
- FMI Support. FMI co-simulation with OpenModelica as master. Improved

FMI Import and export for model exchange. Most of FMI 2.0 is now also supported.

- Checking (when possible) that variables have been assigned to before they are used in algorithmic code (#1776).
- Full version of Python scripting.
- 3D graphics visualization using the Modelica3D library.
- The PySimulator package from DLR for additional analysis is integrated with OpenModelica (see [Modelica2012 paper](#)), and included in the OpenModelica distribution (Windows only).
- Prototype support for uncertainty computations, special feature enabled by special flag.
- Parallel algorithmic Modelica support (ParModelica) for efficient portable parallel algorithmic programming based on the OpenCL standard, for CPUs and GPUs.
- Support for optimization of semiLinear according to MSL 3.3 chapter 3.7.2.5 semiLinear (r12657,r12658).
- The compiler is now fully bootstrapped and can compile itself using a modest amount of heap and stack space (less than the RML-based compiler, which is still the default).
- Some old debug-flags were removed. Others were renamed. Debug flags can now be enabled by default.
- Removed old unused simulation flags noClean and storeInTemp (r15927).
- Many stack overflow issues were resolved.
- Dynamic Optimization with OpenModelica. Dynamic optimization with XML export to the CasADi package is now integrated with OpenModelica. Moreover, a native integrated Dynamic Optimization prototype using Ipopt is now in the OpenModelica release, but currently needs a special flag to be turned on since it needs more testing and refinement before being generally made available.

31.12.2 OpenModelica Notebook (OMNotebook)

- A ``shortOutput`` option has been introduced in the simulate command for less verbose output. The DrModelica interactive document has been updated and the models tested. Almost all models now simulate with OpenModelica.

31.12.3 OpenModelica Eclipse Plug-in (MDT)

- Enhanced debugger for algorithmic Modelica code, supporting both standard Modelica algorithmic code called from simulation models, and MetaModelica code.

31.12.4 OpenModelica Development Environment (OMDev)

- Migration of version handling and configuration management from CodeBeamer to Trac.

31.12.5 Graphic Editor OMEdit

- General GUI: backward and forward navigation support in Documentation view, enhanced parameters window with support for Dialog annotation. Most of the images are converted from raster to vector graphics i.e PNG to SVG.
- Libraries Browser: better loading of libraries, library tree can now show protected classes, show library items class names as middle ellipses if the class name text is larger, more options via the right click menu for quick usage.
- ModelWidget: add the partial class as a replaceable component, look for the default component prefixes and name when adding the component.
- GraphicsView: coordinate system manipulation for icon and diagram layers. Show red box for models that do not exist. Show default graphical annotation for the components that doesn't have any graphical annotations. Better resizing of the components. Properties dialog for primitive shapes i.e Line, Polygon, Rectangle, Ellipse, Text and Bitmap.
- File Opening: open one or more Modelica files, allow users to select the encoding while opening the file, convert files to UTF-8 encoding, allow users to open the OpenModelica result files.
- Variables Browser: find variables in the variables browser, sorting in the variables browser.
- Plot Window: clear all curves of the plot window, preserve the old selected variable and update its value with the new simulation result.
- Simulation: support for all the simulation flags, read the simulation output as soon as it is obtained, output window for simulations, options to set matching algorithm and index reduction method for simulation. Display all the files generated during the simulation is now supported. Options to set OMC command line flags.
- Options: options for loading libraries via `loadModel` and `loadFile` each time GUI starts, save the last open file directory location, options for setting line wrap mode and syntax highlighting.
- Modelica Text Editor: preserving user customizations, new search & replace functionality, support for comment/uncomment.
- Notifications: show custom dialogs to users allowing them to choose whether they want to see this dialog again or not.
- Model Creation: Better support for creating new classes. Easy creation of extends classes or nested classes.
- Messages Widget: Multi line error messages are now supported.
- Crash Detection: The GUI now automatically detects the crash and writes a stack trace file. The user is given an option to send a crash report along with the stack trace file and few other useful files via email.

- Autosave: OMEdit saves the currently edited model regularly, in order to avoid losing edits after GUI or compiler crash. The save interval can be set in the Options menu.

31.12.6 ModelicaML

- Enhanced ModelicaML version with support for value bindings in requirements-driven modeling available for the latest Eclipse and Papyrus versions. GUI specific adaptations. Automated model composition workflows (used for model-based design verification against requirements) are modularized and have improved in terms of performance.

31.13 Release Notes for OpenModelica 1.8.1

The OpenModelica 1.8.1 release has a faster and more stable OMC model compiler. It flattens and simulates more models than the previous 1.8.0 version. Significant flattening speedup of the compiler has been achieved for certain large models. It also contains a New ModelicaML version with support for value bindings in requirements-driven modeling and importing Modelica library models into ModelicaML models. A beta version of the new OpenModelica Python scripting is also included. The release was made on 2012-04-03 (r11645).

31.13.1 OpenModelica Compiler (OMC)

This release includes bug fixes and improvements of the flattening frontend part of the OpenModelica Compiler (OMC) and several improvements of the backend, including, but not restricted to:

- A faster and more stable OMC model compiler. The 1.8.1 version flattens and simulates more models than the previous 1.8.0 version.
- Support for operator overloading (except Complex numbers).
- New ModelicaML version with support for value bindings in requirements-driven modeling and importing Modelica library models into ModelicaML models.
- Faster plotting in OMNotebook. The feature sendData has been removed from OpenModelica. As a result, the kernel no longer depends on Qt. The plot3() family of functions have now replaced to plot(), which in turn have been removed. The non-standard visualize() command has been removed in favour of more recent alternatives.
- Store OpenModelica documentation as Modelica Documentation annotations.
- Re-implementation of the simulation runtime using C instead of C++ (this was needed to export FMI source-based packages).
- FMI import/export bug fixes.
- Changed the internal representation of various structures to share more memory. This significantly improved the performance for very large models that use records.
- Faster model flattening, Improved simulation, some graphical API bug fixes.
- More robust and general initialization, but currently time-consuming.
- New initialization flags to omc and options to simulate(), to control whether fast or robust initialization is selected, or initialization from an external (.mat) data file.
- New options to API calls list, loadFile, and more.
- Enforce the restriction that input arguments of functions may not be assigned to.
- Improved the scripting environment. `cl := $TypeName(Modelica);getClassComment(cl)`; now works as expected. As does looping over lists of typenames and using reduction expressions.
- Beta version of Python scripting.
- Various bugfixes.

- NOTE: interactive simulation is not operational in this release. It will be put back again in the near future, first available as a nightly build. It is also available in the previous 1.8.0 release.

31.13.2 OpenModelica Notebook (OMNotebook)

- Faster and more stable plotting.

31.13.3 OpenModelica Shell (OMShell)

- No changes.

31.13.4 OpenModelica Eclipse Plug-in (MDT)

- Small fixes and improvements.

31.13.5 OpenModelica Development Environment (OMDev)

- No changes.

31.13.6 Graphic Editor OMEdit

- Bug fixes.

31.13.7 OMOptim Optimization Subsystem

- Bug fixes.

31.13.8 FMI Support

- Bug fixes.

31.14 OpenModelica 1.8.0, November 2011

The OpenModelica 1.8.0 release contains OMC flattening improvements for the Media library - it now flattens the whole library and simulates about 20% of its example models. Moreover, about half of the Fluid library models also flatten. This release also includes two new tool functionalities - the FMI for model exchange import and export, and a new efficient Eclipse-based debugger for Modelica/MetaModelica algorithmic code.

31.14.1 OpenModelica Compiler (OMC)

This release includes bug fixes and improvements of the flattening frontend part of the OpenModelica Compiler (OMC) and several improvements of the backend, including, but not restricted to: A faster and more stable OMC model compiler. The 1.8.0 version flattens and simulates more models than the previous 1.7.0 version.

- Flattening of the whole Media library, and about half of the Fluid

library. Simulation of approximately 20% of the Media library example models. - Functional Mockup Interface FMI 1.0 for model exchange, export and import, for the Windows platform. - Bug fixes in the OpenModelica graphical model connection editor OMEdit, supporting easy-to-use graphical drag-and-drop modeling and MSL 3.1. - Bug fixes in the OMOptim optimization subsystem. - Beta version of compiler support for a new Eclipse-based very efficient algorithmic code debugger for functions in MetaModelica/Modelica, available in the development environment when using the bootstrapped OpenModelica compiler. - Improvements in initialization

of simulations. - Improved index reduction with dynamic state selection, which improves simulation. - Better error messages from several parts of the compiler, including a new API call for giving better error messages. - Automatic partitioning of equation systems and multi-core parallel simulation of independent parts based on the shared-memory OpenMP model. This version is a preliminary experimental version without load balancing.

31.14.2 OpenModelica Notebook (OMNotebook)

No changes.

31.14.3 OpenModelica Shell (OMShell)

Small performance improvements.

31.14.4 OpenModelica Eclipse Plug-in (MDT)

Small fixes and improvements. MDT now also includes a beta version of a new Eclipse-based very efficient algorithmic code debugger for functions in MetaModelica/Modelica.

31.14.5 OpenModelica Development Environment (OMDev)

Third party binaries, including Qt libraries and executable Qt clients, are now part of the OMDev package. Also, now uses GCC 4.4.0 instead of the earlier GCC 3.4.5.

31.14.6 Graphic Editor OMEdit

Bug fixes. Access to FMI Import/Export through a pull-down menu. Improved configuration of library loading. A function to go to a specific line number. A button to cancel an on-going simulation. Support for some updated OMC API calls.

31.14.7 New OMOptim Optimization Subsystem

Bug fixes, especially in the Linux version.

31.14.8 FMI Support

The Functional Mockup Interface FMI 1.0 for model exchange import and export is supported by this release. The functionality is accessible via API calls as well as via pull-down menu commands in OMEdit.

31.15 OpenModelica 1.7.0, April 2011

The OpenModelica 1.7.0 release contains OMC flattening improvements for the Media library, better and faster event handling and simulation, and fast MetaModelica support in the compiler, enabling it to compile itself. This release also includes two interesting new tools – the OMOptim optimization subsystem, and a new performance profiler for equation-based Modelica models.

31.15.1 OpenModelica Compiler (OMC)

This release includes bug fixes and performance improvements of the flattening frontend part of the OpenModelica Compiler (OMC) and several improvements of the backend, including, but not restricted to:

- Flattening of the whole Modelica Standard Library 3.1 (MSL 3.1),

except Media and Fluid. - Progress in supporting the Media library, some models now flatten. - Much faster simulation of many models through more efficient handling of alias variables, binary output format, and faster event handling. - Faster and more stable simulation through new improved event handling, which is now default. - Simulation result storage in binary .mat files, and plotting from such files. - Support for Unicode characters in quoted Modelica identifiers, including Japanese and Chinese. - Preliminary MetaModelica 2.0 support. (use `setCommandLineOptions({"+g=MetaModelica"})`). Execution is as fast as MetaModelica 1.0, except for garbage collection. - Preliminary bootstrapped OpenModelica compiler: OMC now compiles itself, and the bootstrapped compiler passes the test suite. A garbage collector is still missing. - Many bug fixes.

31.15.2 OpenModelica Notebook (OMNotebook)

Improved much faster and more stable 2D plotting through the new OMPlot module. Plotting from binary .mat files. Better integration between OMEdit and OMNotebook, copy/paste between them.

31.15.3 OpenModelica Shell (OMShell)

Same as previously, except the improved 2D plotting through OMPlot.

31.15.4 Graphic Editor OMEdit

Several enhancements of OMEdit are included in this release. Support for Icon editing is now available. There is also an improved much faster 2D plotting through the new OMPlot module. Better integration between OMEdit and OMNotebook, with copy/paste between them. Interactive on-line simulation is available in an easy-to-use way.

31.15.5 New OMOptim Optimization Subsystem

A new optimization subsystem called OMOptim has been added to OpenModelica. Currently, parameter optimization using genetic algorithms is supported in this version 0.9. Pareto front optimization is also supported.

31.15.6 New Performance Profiler

A new, low overhead, performance profiler for Modelica models has been developed.

31.16 OpenModelica 1.6.0, November 2010

The OpenModelica 1.6.0 release primarily contains flattening, simulation, and performance improvements regarding Modelica Standard Library 3.1 support, but also has an interesting new tool – the OMEdit graphic connection editor, and a new educational material called DrControl, and an improved ModelicaML UML/Modelica profile with better support for modeling and requirement handling.

31.16.1 OpenModelica Compiler (OMC)

This release includes bug fix and performance improvements of the flattening frontend part of the OpenModelica Compiler (OMC) and some improvements of the backend, including, but not restricted to:

- Flattening of the whole Modelica Standard Library 3.1 (MSL 3.1),

except Media and Fluid. - Improved flattening speed of a factor of 5-20 compared to OpenModelica 1.5 for a number of models, especially in the MultiBody library. - Reduced memory consumption by the OpenModelica compiler frontend, for certain large models a reduction of a factor 50. - Reorganized, more modular OpenModelica compiler backend, can now handle approximately 30 000 equations, compared to previously approximately 10 000 equations. - Better error messages from the compiler, especially regarding functions. - Improved simulation coverage of MSL 3.1. Many models that did not simulate before are now simulating. However, there are still many models in certain sublibraries that do not simulate. - Progress in supporting the Media library, but simulation is not yet possible. - Improved support for enumerations, both in the frontend and the backend. - Implementation of stream connectors. - Support for linearization through symbolic Jacobians. - Many bug fixes.

31.16.2 OpenModelica Notebook (OMNotebook)

A new DrControl electronic notebook for teaching control and modeling with Modelica.

31.16.3 OpenModelica Development Environment (OMDev)

Several enhancements. Support for match-expressions in addition to matchcontinue. Support for real if-then-else. Support for if-then without else-branches. Modelica Development Tooling 0.7.7 with small improvements such as more settings, improved error detection in console, etc.

31.16.4 New Graphic Editor OMEdit

A new improved open source graphic model connection editor called OMEdit, supporting 3.1 graphical annotations, which makes it possible to move models back and forth to other tools without problems. The editor has been implemented by students at Linköping University and is based on the C++ Qt library.

31.17 OpenModelica 1.5.0, July 2010

This OpenModelica 1.5 release has major improvements in the OpenModelica compiler frontend and some in the backend. A major improvement of this release is full flattening support for the MultiBody library as well as limited simulation support for MultiBody. Interesting new facilities are the interactive simulation and the integrated UML-Modelica modeling with ModelicaML. Approximately 4 person-years of additional effort have been invested in the compiler compared to the 1.4.5 version, e.g., in order to have a more complete coverage of Modelica 3.0, mainly focusing on improved flattening in the compiler frontend.

31.17.1 OpenModelica Compiler (OMC)

This release includes major improvements of the flattening frontend part of the OpenModelica Compiler (OMC) and some improvements of the backend, including, but not restricted to:

- Improved flattening speed of at least a factor of 10 or more compared

to the 1.4.5 release, primarily for larger models with inner-outer, but also speedup for other models, e.g. the robot model flattens in approximately 2 seconds. - Flattening of all MultiBody models, including all elementary models, breaking connection graphs, world object, etc. Moreover, simulation is now possible for at least five MultiBody models: Pendulum, DoublePendulum, InitSpringConstant, World, PointGravityWithPointMasses. - Progress in supporting the Media library, but simulation is not yet possible. - Support for enumerations, both in the frontend and the backend. - Support for expandable connectors. - Support for the inline and late inline annotations in functions. - Complete support for record constructors, also for records containing other records. - Full support

for iterators, including nested ones. - Support for inferred iterator and for-loop ranges. - Support for the function derivative annotation. - Prototype of interactive simulation. - Prototype of integrated UML-Modelica modeling and simulation with ModelicaML. - A new bidirectional external Java interface for calling external Java functions, or for calling Modelica functions from Java. - Complete implementation of replaceable model extends. - Fixed problems involving arrays of unknown dimensions. - Limited support for tearing. - Improved error handling at division by zero. - Support for Modelica 3.1 annotations. - Support for all MetaModelica language constructs inside OpenModelica. - OpenModelica works also under 64-bit Linux and Mac 64-bit OSX. - Parallel builds and running test suites in parallel on multi-core platforms. - New OpenModelica text template language for easier implementation of code generators, XML generators, etc. - New OpenModelica code generators to C and C# using the text template language. - Faster simulation result data file output optionally as comma-separated values. - Many bug fixes.

It is now possible to graphically edit models using parts from the Modelica Standard Library 3.1, since the sim-Forge graphical editor (from Politecnico di Milano) that is used together with OpenModelica has been updated to version 0.9.0 with a important new functionality, including support for Modelica 3.1 and 3.0 annotations. The 1.6 and 2.2.1 Modelica graphical annotation versions are still supported.

31.17.2 OpenModelica Notebook (OMNotebook)

Improvements in platform availability.

- Support for 64-bit Linux. - Support for Windows 7. - Better support for MacOS, including 64-bit OSX.

31.18 OpenModelica 1.4.5, January 2009

This release has several improvements, especially platform availability, less compiler memory usage, and supporting more aspects of Modelica 3.0.

31.18.1 OpenModelica Compiler (OMC)

This release includes small improvements and some bugfixes of the OpenModelica Compiler (OMC):

- Less memory consumption and better memory management over time. This also includes a better API supporting automatic memory management when calling C functions from within the compiler. - Modelica 3.0 parsing support. - Export of DAE to XML and MATLAB. - Support for several platforms Linux, MacOS, Windows (2000, Xp, Vista). - Support for record and strings as function arguments. - Many bug fixes. - (Not part of OMC): Additional free graphic editor SimForge can be used with OpenModelica.

31.18.2 OpenModelica Notebook (OMNotebook)

A number of improvements, primarily in the plotting functionality and platform availability.

- A number of improvements in the plotting functionality: scalable plots, zooming, logarithmic plots, grids, etc. - Programmable plotting accessible through a Modelica API. - Simple 3D visualization. - Support for several platforms Linux, MacOS, Windows (2000, Xp, Vista).

31.19 OpenModelica 1.4.4, Feb 2008

This release is primarily a bug fix release, except for a preliminary version of new plotting functionality available both from the OMNotebook and separately through a Modelica API. This is also the first release under the open source license OSMC-PL (Open Source Modelica Consortium Public License), with support from the recently created Open Source Modelica Consortium. An integrated version handler, bug-, and issue tracker has also been added.

31.19.1 OpenModelica Compiler (OMC)

This release includes small improvements and some bugfixes of the OpenModelica Compiler (OMC):

- Better support for if-equations, also inside when. - Better support

for calling functions in parameter expressions and interactively through dynamic loading of functions. - Less memory consumption during compilation and interactive evaluation. - A number of bug-fixes.

31.19.2 OpenModelica Notebook (OMNotebook)

Test release of improvements, primarily in the plotting functionality and platform availability.

- Preliminary version of improvements in the plotting functionality:

scalable plots, zooming, logarithmic plots, grids, etc., currently available in a preliminary version through the plot2 function. - Programmable plotting accessible through a Modelica API.

31.19.3 OpenModelica Eclipse Plug-in (MDT)

This release includes minor bugfixes of MDT and the associated MetaModelica debugger.

31.19.4 OpenModelica Development Environment (OMDev)

Extended test suite with a better structure. Version handling, bug tracking, issue tracking, etc. now available under the integrated Codebeamer.

31.20 OpenModelica 1.4.3, June 2007

This release has a number of significant improvements of the OMC compiler, OMNotebook, the MDT plugin and the OMDev. Increased platform availability now also for Linux and Macintosh, in addition to Windows. OMShell is the same as previously, but now ported to Linux and Mac.

31.20.1 OpenModelica Compiler (OMC)

This release includes a number of improvements of the OpenModelica Compiler (OMC):

- Significantly increased compilation speed, especially with large

models and many packages. - Now available also for Linux and Macintosh platforms. - Support for when-equations in algorithm sections, including elsewhere. - Support for inner/outer prefixes of components (but without type error checking). - Improved solution of nonlinear systems. - Added ability to compile generated simulation code using Visual Studio compiler. - Added "smart setting of fixed attribute to false. If initial equations, OMC instead has fixed=true as default for states due to allowing overdetermined initial equation systems. - Better state select heuristics. - New function getIncidenceMatrix(ClassName) for dumping the incidence matrix. - Builtin functions String(), product(), ndims(), implemented. - Support for terminate() and assert() in equations. - In emitted flat form: protected variables are now prefixed with protected when printing flat class. - Some support for tables, using omcTableTimeIni instead of dymTableTimeIni2. - Better support for empty arrays, and support

for matrix operations like `a*[1,2;3,4]`. - Improved `val()` function can now evaluate array elements and record fields, e.g. `val(x[n])`, `val(x.y)`. - Support for `reinit` in algorithm sections. - String support in external functions. - Double precision floating point precision now also for interpreted expressions - Better simulation error messages. - Support for `der(expressions)`. - Support for iterator expressions such as `{3*i for i in 1..10}`. - More test cases in the test suite. - A number of bug fixes, including sample and event handling bugs.

31.20.2 OpenModelica Notebook (OMNotebook)

A number of improvements, primarily in the platform availability.

- Available on the Linux and Macintosh platforms, in addition to Windows. - Fixed cell copying bugs, plotting of derivatives now works, etc.

31.20.3 OpenModelica Shell (OMShell)

Now available also on the Macintosh platform.

31.20.4 OpenModelica Eclipse Plug-in (MDT)

This release includes major improvements of MDT and the associated MetaModelica debugger:

- Greatly improved browsing and code completion works both for standard Modelica and for MetaModelica. - Hovering over identifiers displays type information. - A new and greatly improved implementation of the debugger for MetaModelica algorithmic code, operational in Eclipse. Greatly improved performance - only approx 10% speed reduction even for 100 000 line programs. Greatly improved single stepping, step over, data structure browsing, etc. - Many bug fixes.

31.20.5 OpenModelica Development Environment (OMDev)

Increased compilation speed for MetaModelica. Better if-expression support in MetaModelica.

31.21 OpenModelica 1.4.2, October 2006

This release has improvements and bug fixes of the OMC compiler, OMNotebook, the MDT plugin and the OMDev. OMShell is the same as previously.

31.21.1 OpenModelica Compiler (OMC)

This release includes further improvements of the OpenModelica Compiler (OMC):

- Improved initialization and index reduction. - Support for integer arrays is now largely implemented. - The `val(variable,time)` scripting function for accessing the value of a simulation result variable at a certain point in the simulated time. - Interactive evaluation of for-loops, while-loops, if-statements, if-expressions, in the interactive scripting mode. - Improved documentation and examples of calling the Model Query and Manipulation API. - Many bug fixes.

31.21.2 OpenModelica Notebook (OMNotebook)

Search and replace functions have been added. The DrModelica tutorial (all files) has been updated, obsolete sections removed, and models which are not supported by the current implementation marked clearly. Automatic recognition of the .onb suffix (e.g. when double-clicking) in Windows makes it even more convenient to use.

31.21.3 OpenModelica Eclipse Plug-in (MDT)

Two major improvements are added in this release:

- Browsing and code completion works both for standard Modelica and for

MetaModelica. - The debugger for algorithmic code is now available and operational in Eclipse for debugging of MetaModelica programs.

31.22 OpenModelica 1.4.1, June 2006

This release has only improvements and bug fixes of the OMC compiler, the MDT plugin and the OMDev components. The OMSHELL and OMNotebook are the same.

31.22.1 OpenModelica Compiler (OMC)

This release includes further improvements of the OpenModelica Compiler (OMC):

- Support for external objects. - OMC now reports the version number

(via command line switches or CORBA API getVersion()). - Implemented caching for faster instantiation of large models. - Many bug fixes.

31.22.2 OpenModelica Eclipse Plug-in (MDT)

Improvements of the error reporting when building the OMC compiler. The errors are now added to the problems view. The latest MDT release is version 0.6.6 (2006-06-06).

31.22.3 OpenModelica Development Environment (OMDev)

Small fixes in the MetaModelica compiler. MetaModelica Users Guide is now part of the OMDev release. The latest OMDev was release in 2006-06-06.

31.23 OpenModelica 1.4.0, May 2006

This release has a number of improvements described below. The most significant change is probably that OMC has now been translated to an extended subset of Modelica (MetaModelica), and that all development of the compiler is now done in this version..

31.23.1 OpenModelica Compiler (OMC)

This release includes further improvements of the OpenModelica Compiler (OMC):

- Partial support for mixed system of equations. - New initialization

routine, based on optimization (minimizing residuals of initial equations). - Symbolic simplification of builtin operators for vectors and matrices. - Improved code generation in simulation code to support e.g. Modelica functions. - Support for classes extending basic types, e.g. connectors (support for MSL 2.2 block connectors). - Support for parametric plotting via the plotParametric command. - Many bug fixes.

31.23.2 OpenModelica Shell (OMShell)

Essentially the same OMShell as in 1.3.1. One difference is that now all error messages are sent to the command window instead of to a separate log window.

31.23.3 OpenModelica Notebook (OMNotebook)

Many significant improvements and bug fixes. This version supports graphic plots within the cells in the notebook. Improved cell handling and Modelica code syntax highlighting. Command completion of the most common OMC commands is now supported. The notebook has been used in several courses.

31.23.4 OpenModelica Eclipse Plug-in (MDT)

This is the first really useful version of MDT. Full browsing of Modelica code, e.g. the MSL 2.2, is now supported. (MetaModelica browsing is not yet fully supported). Full support for automatic indentation of Modelica code, including the MetaModelica extensions. Many bug fixes. The Eclipse plug-in is now in use for OpenModelica development at PELAB and MathCore Engineering AB since approximately one month.

31.23.5 OpenModelica Development Environment (OMDev)

The following mechanisms have been put in place to support OpenModelica development.

- A separate web page for OMDev (OpenModelica Development Environment).
- A pre-packaged OMDev zip-file with precompiled binaries for

development under Windows using the mingw Gnu compiler from the Eclipse MDT plug-in. (Development is also possible using Visual Studio). - All source code of the OpenModelica compiler has recently been translated to an extended subset of Modelica, currently called MetaModelica. The current size of OMC is approximately 100 000 lines All development is now done in this version. - A new tutorial and users guide for development in MetaModelica. - Successful builds and tests of OMC under Linux and Solaris.

31.24 OpenModelica 1.3.1, November 2005

This release has several important highlights.

This is also the *first* release for which the New BSD (Berkeley) open-source license applies to the source code, including the whole compiler and run-time system. This makes it possible to use OpenModelica for both academic and commercial purposes without restrictions.

31.24.1 OpenModelica Compiler (OMC)

This release includes a significantly improved OpenModelica Compiler (OMC):

- Support for hybrid and discrete-event simulation (if-equations,

if-expressions, when-equations; not yet if-statements and when-statements). - Parsing of full Modelica 2.2 - Improved support for external functions. - Vectorization of function arguments; each-modifiers, better implementation of replaceable, better handling of structural parameters, better support for vector and array operations, and many other improvements. - Flattening of the Modelica Block library version 1.5 (except a few models), and simulation of most of these. - Automatic index reduction (present also in previous release). - Updated User's Guide including examples of hybrid simulation and external functions.

31.24.2 OpenModelica Shell (OMShell)

An improved window-based interactive command shell, now including command completion and better editing and font size support.

31.24.3 OpenModelica Notebook (OMNotebook)

A free implementation of an OpenModelica notebook (OMNotebook), for electronic books with course material, including the DrModelica interactive course material. It is possible to simulate and plot from this notebook.

31.24.4 OpenModelica Eclipse Plug-in (MDT)

An early alpha version of the first Eclipse plug-in (called MDT for Modelica Development Tooling) for Modelica Development. This version gives compilation support and partial support for browsing Modelica package hierarchies and classes.

31.24.5 OpenModelica Development Environment (OMDev)

The following mechanisms have been put in place to support OpenModelica development.

- Bugzilla support for OpenModelica bug tracking, accessible to anybody.
- A system for automatic regression testing of the compiler and

simulator, (+ other system parts) usually run at check in time. - Version handling is done using SVN, which is better than the previously used CVS system. For example, name change of modules is now possible within the version handling system.

CONTRIBUTORS TO OPENMODELICA

This Appendix lists the individuals who have made significant contributions to OpenModelica, in the form of software development, design, documentation, project leadership, tutorial material, promotion, etc. The individuals are listed for each year, from 1998 to the current year: the project leader and main author/editor of this document followed by main contributors followed by contributors in alphabetical order.

32.1 OpenModelica Contributors 2015

Peter Fritzson, PELAB, Linköping University, Linköping, Sweden.

Adrian Pop, PELAB, Linköping University, Linköping, Sweden.

Adeel Asghar, PELAB, Linköping University, Linköping, Sweden.

Willi Braun, Fachhochschule Bielefeld, Bielefeld, Germany.

Lennart Ochel, Fachhochschule Bielefeld, Bielefeld, Germany.

Martin Sjölund, PELAB, Linköping University, Linköping, Sweden.

Volker Waurich, TU Dresden, Dresden, Germany.

Per Östlund, PELAB, Linköping University, Linköping, Sweden.

Anders Andersson, VTI, Linköping, Sweden.

Peter Aronsson, MathCore Engineering AB, Linköping, Sweden.

Bernhard Bachmann, Fachhochschule Bielefeld, Bielefeld, Germany.

Robert Braun, IEL, Linköping University, Linköping, Sweden.

David Broman, PELAB, Linköping University, Linköping, Sweden.

Daniel Bouskela, EDF, Paris, France.

Lena Buffoni, PELAB, Linköping University, Linköping, Sweden.

Francesco Casella, Politecnico di Milano, Milan, Italy.

Atiyah Elsheikh, AIT, Vienna, Austria.

Rüdiger Franke, ABB, Germany

Jens Frenkel, TU Dresden, Dresden, Germany.

Mahder Gebremedhin, PELAB, Linköping University, Linköping, Sweden.

Pavel Grozman, Equa AB, Stockholm, Sweden.
Daniel Hedberg, MathCore Engineering AB, Linköping, Sweden.
Alf Isaksson, ABB Corporate Research, Västerås, Sweden.
Daniel Kanth, Bosch-Rexroth, Lohr am Main, Germany.
Henning Kiel, Bocholt, Germany.
Tommi Karhela, VTT, Espoo, Finland.
Petter Krus, IEI, Linköping University, Linköping, Sweden.
Juha Kortelainen, VTT, Espoo, Finland.
Leonardo Laguna, Wolfram MathCore AB, Linköping, Sweden.
Alexey Lebedev, Equa Simulation AB, Stockholm, Sweden.
Oliver Lenord, Siemens PLM, California, USA.
Ariel Liebman, Energy Users Association of Australia, Victoria, Australia.
Alachew Mengist, PELAB, Linköping University, Linköping, Sweden.
Abhir Raj Metkar, CDAC, Trivandrum, Kerala, India.
Eric Meyers, Pratt & Whitney Rocketdyne, Palm City, Florida, USA.
Lars Mikelsons, Bosch Rexroth, Lohr am Main, Germany.
Afshin Moghadam, PELAB, Linköping University, Linköping, Sweden.
Kannan Moudgalya, IIT Bombay, Mumbai, India.
Kenneth Nealy, USA.
Maroun Nemer, CEP Paristech, Ecole des Mines, Paris, France.
Hannu Niemistö, VTT, Espoo, Finland.
Peter Nordin, IEI, Linköping University, Linköping, Sweden.
Arunkumar Palanisamy, PELAB, Linköping University, Linköping, Sweden.
Pavol Privitzer, Institute of Pathological Physiology, Praha, Czech Republic.
Vitalij Ruge, Fachhochschule Bielefeld, Bielefeld, Germany.
Per Sahlin, Equa Simulation AB, Stockholm, Sweden.
Roland Samlaus, Bosch, Stuttgart, Germany.
Wladimir Schamai, EADS, Hamburg, Germany.
Gerhard Schmitz, University of Hamburg, Hamburg, Germany.
Jan Šilar, Charles University, Prague, Czech Republic
Kristian Stavåker, PELAB, Linköping University, Linköping, Sweden.
Sonia Tariq, PELAB, Linköping University, Linköping, Sweden.
Bernhard Thiele, PELAB, Linköping University, Linköping, Sweden
Hubert Thierot, CEP Paristech, Ecole des Mines, Paris, France.
Gustaf Thorslund, PELAB, Linköping University, Linköping, Sweden.
Mohsen Torabzadeh-Tari, PELAB, Linköping University, Linköping, Sweden.
Marcus Walther, TU Dresden, Dresden, Germany
Niklas Worschech, Bosch-Rexroth, Lohr am Main, Germany.

32.2 OpenModelica Contributors 2014

Peter Fritzson, PELAB, Linköping University, Linköping, Sweden.

Adrian Pop, PELAB, Linköping University, Linköping, Sweden.

Adeel Asghar, PELAB, Linköping University, Linköping, Sweden.

Willi Braun, Fachhochschule Bielefeld, Bielefeld, Germany.

Jens Frenkel, TU Dresden, Dresden, Germany.

Lennart Ochel, Fachhochschule Bielefeld, Bielefeld, Germany.

Martin Sjölund, PELAB, Linköping University, Linköping, Sweden.

Per Östlund, PELAB, Linköping University, Linköping, Sweden.

Peter Aronsson, MathCore Engineering AB, Linköping, Sweden.

Bernhard Bachmann, Fachhochschule Bielefeld, Bielefeld, Germany.

Vasile Baluta, PELAB, Linköping University, Linköping, Sweden.

Robert Braun, IEI, Linköping University, Linköping, Sweden.

David Broman, PELAB, Linköping University, Linköping, Sweden.

Stefan Brus, PELAB, Linköping University, Linköping, Sweden.

Lena Buffoni, PELAB, Linköping University, Linköping, Sweden.

Francesco Casella, Politecnico di Milano, Milan, Italy.

Filippo Donida, Politecnico di Milano, Milan, Italy.

Mahder Gebremedhin, PELAB, Linköping University, Linköping, Sweden.

Pavel Grozman, Equa AB, Stockholm, Sweden.

Michael Hanke, NADA, KTH, Stockholm.

Daniel Hedberg, MathCore Engineering AB, Linköping, Sweden.

Zoheb Hossain, PELAB, Linköping University, Linköping, Sweden.

Alf Isaksson, ABB Corporate Research, Västerås, Sweden.

Daniel Kanth, Bosch-Rexroth, Lohr am Main, Germany.

Tommi Karhela, VTT, Espoo, Finland.

Petter Krus, IEI, Linköping University, Linköping, Sweden.

Juha Kortelainen, VTT, Espoo, Finland.

Abhinn Kothari, PELAB, Linköping University, Linköping, Sweden.

Alexey Lebedev, Equa Simulation AB, Stockholm, Sweden.

Oliver Lenord, Siemens PLM, California, USA.

Ariel Liebman, Energy Users Association of Australia, Victoria, Australia.

Henrik Magnusson, Linköping, Sweden.

Abhi Raj Metkar, CDAC, Trivandrum, Kerala, India.

Eric Meyers, Pratt & Whitney Rocketdyne, Palm City, Florida, USA.
Tuomas Miettinen, VTT, Espoo, Finland.
Afshin Moghadam, PELAB, Linköping University, Linköping, Sweden.
Maroun Nemer, CEP Paristech, Ecole des Mines, Paris, France.
Hannu Niemistö, VTT, Espoo, Finland.
Peter Nordin, IEI, Linköping University, Linköping, Sweden.
Arunkumar Palanisamy, PELAB, Linköping University, Linköping, Sweden.
Karl Pettersson, IEI, Linköping University, Linköping, Sweden.
Pavol Privitzer, Institute of Pathological Physiology, Praha, Czech Republic.
Jhansi Remala, PELAB, Linköping University, Linköping, Sweden.
Reino Ruusu, VTT, Espoo, Finland.
Per Sahlin, Equa Simulation AB, Stockholm, Sweden.
Wladimir Schamai, EADS, Hamburg, Germany.
Gerhard Schmitz, University of Hamburg, Hamburg, Germany.
Alachew Shitahun, PELAB, Linköping University, Linköping, Sweden.
Anton Sodja, University of Ljubljana, Ljubljana, Slovenia
Ingo Staack, IEI, Linköping University, Linköping, Sweden.
Kristian Stavåker, PELAB, Linköping University, Linköping, Sweden.
Sonia Tariq, PELAB, Linköping University, Linköping, Sweden.
Hubert Thierot, CEP Paristech, Ecole des Mines, Paris, France.
Mohsen Torabzadeh-Tari, PELAB, Linköping University, Linköping, Sweden.
Parham Vasaiely, EADS, Hamburg, Germany.
Niklas Worschech, Bosch-Rexroth, Lohr am Main, Germany.
Robert Wotzlaw, Goettingen, Germany.
Azam Zia, PELAB, Linköping University, Linköping, Sweden.

32.3 OpenModelica Contributors 2013

Peter Fritzson, PELAB, Linköping University, Linköping, Sweden.

Adrian Pop, PELAB, Linköping University, Linköping, Sweden.
Adeel Asghar, PELAB, Linköping University, Linköping, Sweden.
Willi Braun, Fachhochschule Bielefeld, Bielefeld, Germany.
Jens Frenkel, TU Dresden, Dresden, Germany.
Lennart Ochel, Fachhochschule Bielefeld, Bielefeld, Germany.
Martin Sjölund, PELAB, Linköping University, Linköping, Sweden.
Per Östlund, PELAB, Linköping University, Linköping, Sweden.

Peter Aronsson, MathCore Engineering AB, Linköping, Sweden.
Bernhard Bachmann, Fachhochschule Bielefeld, Bielefeld, Germany.
Vasile Baluta, PELAB, Linköping University, Linköping, Sweden.
Robert Braun, IEI, Linköping University, Linköping, Sweden.
David Broman, PELAB, Linköping University, Linköping, Sweden.
Stefan Brus, PELAB, Linköping University, Linköping, Sweden.
Lena Buffoni, PELAB, Linköping University, Linköping, Sweden.
Francesco Casella, Politecnico di Milano, Milan, Italy.
Filippo Donida, Politecnico di Milano, Milan, Italy.
Mahder Gebremedhin, PELAB, Linköping University, Linköping, Sweden.
Pavel Grozman, Equa AB, Stockholm, Sweden.
Michael Hanke, NADA, KTH, Stockholm.
Daniel Hedberg, MathCore Engineering AB, Linköping, Sweden.
Zoheb Hossain, PELAB, Linköping University, Linköping, Sweden.
Alf Isaksson, ABB Corporate Research, Västerås, Sweden.
Daniel Kanth, Bosch-Rexroth, Lohr am Main, Germany.
Tommi Karhela, VTT, Espoo, Finland.
Petter Krus, IEI, Linköping University, Linköping, Sweden.
Juha Kortelainen, VTT, Espoo, Finland.
Abhinn Kothari, PELAB, Linköping University, Linköping, Sweden.
Alexey Lebedev, Equa Simulation AB, Stockholm, Sweden.
Oliver Lenord, Siemens PLM, California, USA.
Ariel Liebman, Energy Users Association of Australia, Victoria, Australia.
Henrik Magnusson, Linköping, Sweden.
Abhi Raj Metkar, CDAC, Trivandrum, Kerala, India.
Eric Meyers, Pratt & Whitney Rocketdyne, Palm City, Florida, USA.
Tuomas Miettinen, VTT, Espoo, Finland.
Afshin Moghadam, PELAB, Linköping University, Linköping, Sweden.
Maroun Nemer, CEP Paristech, Ecole des Mines, Paris, France.
Hannu Niemistö, VTT, Espoo, Finland.
Peter Nordin, IEI, Linköping University, Linköping, Sweden.
Arunkumar Palanisamy, PELAB, Linköping University, Linköping, Sweden.
Karl Pettersson, IEI, Linköping University, Linköping, Sweden.
Pavol Privitzer, Institute of Pathological Physiology, Praha, Czech Republic.
Jhansi Remala, PELAB, Linköping University, Linköping, Sweden.
Reino Ruusu, VTT, Espoo, Finland.
Per Sahlin, Equa Simulation AB, Stockholm, Sweden.
Wladimir Schamai, EADS, Hamburg, Germany.
Gerhard Schmitz, University of Hamburg, Hamburg, Germany.
Alachew Shitahun, PELAB, Linköping University, Linköping, Sweden.
Anton Sodja, University of Ljubljana, Ljubljana, Slovenia

Ingo Staack, IEI, Linköping University, Linköping, Sweden.
Kristian Stavåker, PELAB, Linköping University, Linköping, Sweden.
Sonia Tariq, PELAB, Linköping University, Linköping, Sweden.
Hubert Thierot, CEP Paristech, Ecole des Mines, Paris, France.
Mohsen Torabzadeh-Tari, PELAB, Linköping University, Linköping, Sweden.
Parham Vasaiely, EADS, Hamburg, Germany.
Niklas Worschech, Bosch-Rexroth, Lohr am Main, Germany.
Robert Wotzlaw, Goettingen, Germany.
Azam Zia, PELAB, Linköping University, Linköping, Sweden.

32.4 OpenModelica Contributors 2012

Peter Fritzson, PELAB, Linköping University, Linköping, Sweden.

Adrian Pop, PELAB, Linköping University, Linköping, Sweden.
Adeel Asghar, PELAB, Linköping University, Linköping, Sweden.
Willi Braun, Fachhochschule Bielefeld, Bielefeld, Germany.
Jens Frenkel, TU Dresden, Dresden, Germany.
Lennart Ochel, Fachhochschule Bielefeld, Bielefeld, Germany.
Martin Sjölund, PELAB, Linköping University, Linköping, Sweden.
Per Östlund, PELAB, Linköping University, Linköping, Sweden.

Peter Aronsson, MathCore Engineering AB, Linköping, Sweden.
David Akhvlediani, PELAB, Linköping University, Linköping, Sweden.
Mikael Axin, IEI, Linköping University, Linköping, Sweden.
Bernhard Bachmann, Fachhochschule Bielefeld, Bielefeld, Germany.
Vasile Baluta, PELAB, Linköping University, Linköping, Sweden.
Robert Braun, IEI, Linköping University, Linköping, Sweden.
David Broman, PELAB, Linköping University, Linköping, Sweden.
Stefan Brus, PELAB, Linköping University, Linköping, Sweden.
Francesco Casella, Politecnico di Milano, Milan, Italy.
Filippo Donida, Politecnico di Milano, Milan, Italy.
Mahder Gebremedhin, PELAB, Linköping University, Linköping, Sweden.
Pavel Grozman, Equa AB, Stockholm, Sweden.
Michael Hanke, NADA, KTH, Stockholm.
Daniel Hedberg, MathCore Engineering AB, Linköping, Sweden.
Zoheb Hossain, PELAB, Linköping University, Linköping, Sweden.

Alf Isaksson, ABB Corporate Research, Västerås, Sweden.
Daniel Kanth, Bosch-Rexroth, Lohr am Main, Germany.
Tommi Karhela, VTT, Espoo, Finland.
Petter Krus, IEI, Linköping University, Linköping, Sweden.
Juha Kortelainen, VTT, Espoo, Finland.
Abhinn Kothari, PELAB, Linköping University, Linköping, Sweden.
Alexey Lebedev, Equa Simulation AB, Stockholm, Sweden.
Oliver Lenord, Siemens PLM, California, USA.
Ariel Liebman, Energy Users Association of Australia, Victoria, Australia.
Henrik Magnusson, Linköping, Sweden.
Abhi Raj Metkar, CDAC, Trivandrum, Kerala, India.
Eric Meyers, Pratt & Whitney Rocketdyne, Palm City, Florida, USA.
Tuomas Miettinen, VTT, Espoo, Finland.
Afshin Moghadam, PELAB, Linköping University, Linköping, Sweden.
Maroun Nemer, CEP Paristech, Ecole des Mines, Paris, France.
Hannu Niemistö, VTT, Espoo, Finland.
Peter Nordin, IEI, Linköping University, Linköping, Sweden.
Arunkumar Palanisamy, PELAB, Linköping University, Linköping, Sweden.
Karl Pettersson, IEI, Linköping University, Linköping, Sweden.
Pavol Privitzer, Institute of Pathological Physiology, Praha, Czech Republic.
Jhansi Remala, PELAB, Linköping University, Linköping, Sweden.
Reino Ruusu, VTT, Espoo, Finland.
Per Sahlin, Equa Simulation AB, Stockholm, Sweden.
Wladimir Schamai, EADS, Hamburg, Germany.
Gerhard Schmitz, University of Hamburg, Hamburg, Germany.
Alachew Shitahun, PELAB, Linköping University, Linköping, Sweden.
Anton Sodja, University of Ljubljana, Ljubljana, Slovenia
Ingo Staack, IEI, Linköping University, Linköping, Sweden.
Kristian Stavåker, PELAB, Linköping University, Linköping, Sweden.
Sonia Tariq, PELAB, Linköping University, Linköping, Sweden.
Hubert Thierot, CEP Paristech, Ecole des Mines, Paris, France.
Mohsen Torabzadeh-Tari, PELAB, Linköping University, Linköping, Sweden.
Parham Vasaiely, EADS, Hamburg, Germany.
Niklas Worschech, Bosch-Rexroth, Lohr am Main, Germany.
Robert Wotzlaw, Goettingen, Germany.
Azam Zia, PELAB, Linköping University, Linköping, Sweden.

32.5 OpenModelica Contributors 2011

Peter Fritzson, PELAB, Linköping University, Linköping, Sweden.

Adrian Pop, PELAB, Linköping University, Linköping, Sweden.

Willi Braun, Fachhochschule Bielefeld, Bielefeld, Germany.

Jens Frenkel, TU Dresden, Dresden, Germany.

Martin Sjölund, PELAB, Linköping University, Linköping, Sweden.

Per Östlund, PELAB, Linköping University, Linköping, Sweden.

Peter Aronsson, MathCore Engineering AB, Linköping, Sweden.

Adeel Asghar, PELAB, Linköping University, Linköping, Sweden.

David Akhvlediani, PELAB, Linköping University, Linköping, Sweden.

Mikael Axin, IEI, Linköping University, Linköping, Sweden.

Bernhard Bachmann, Fachhochschule Bielefeld, Bielefeld, Germany.

Vasile Baluta, PELAB, Linköping University, Linköping, Sweden.

Robert Braun, IEI, Linköping University, Linköping, Sweden.

David Broman, PELAB, Linköping University, Linköping, Sweden.

Stefan Brus, PELAB, Linköping University, Linköping, Sweden.

Francesco Casella, Politecnico di Milano, Milan, Italy.

Filippo Donida, Politecnico di Milano, Milan, Italy.

Anand Ganeson, PELAB, Linköping University, Linköping, Sweden.

Mahder Gebremedhin, PELAB, Linköping University, Linköping, Sweden.

Pavel Grozman, Equa AB, Stockholm, Sweden.

Michael Hanke, NADA, KTH, Stockholm.

Daniel Hedberg, MathCore Engineering AB, Linköping, Sweden.

Zoheb Hossain, PELAB, Linköping University, Linköping, Sweden.

Alf Isaksson, ABB Corporate Research, Västerås, Sweden.

Kim Jansson, PELAB, Linköping University, Linköping, Sweden.

Daniel Kanth, Bosch-Rexroth, Lohr am Main, Germany.

Tommi Karhela, VTT, Espoo, Finland.

Joel Klinghed, PELAB, Linköping University, Linköping, Sweden.

Petter Krus, IEI, Linköping University, Linköping, Sweden.

Juha Kortelainen, VTT, Espoo, Finland.

Abhinn Kothari, PELAB, Linköping University, Linköping, Sweden.

Alexey Lebedev, Equa Simulation AB, Stockholm, Sweden.

Oliver Lenord, Siemens PLM, California, USA.

Ariel Liebman, Energy Users Association of Australia, Victoria, Australia.
Rickard Lindberg, PELAB, Linköping University, Linköping, Sweden
Håkan Lundvall, PELAB, Linköping University, Linköping, Sweden.
Henrik Magnusson, Linköping, Sweden.
Abhi Raj Metkar, CDAC, Trivandrum, Kerala, India.
Eric Meyers, Pratt & Whitney Rocketdyne, Palm City, Florida, USA.
Tuomas Miettinen, VTT, Espoo, Finland.
Afshin Moghadam, PELAB, Linköping University, Linköping, Sweden.
Maroun Nemer, CEP Paristech, Ecole des Mines, Paris, France.
Hannu Niemistö, VTT, Espoo, Finland.
Peter Nordin, IEI, Linköping University, Linköping, Sweden.
Kristoffer Norling, PELAB, Linköping University, Linköping, Sweden.
Lennart Ochel, Fachhochschule Bielefeld, Bielefeld, Germany.
Karl Pettersson, IEI, Linköping University, Linköping, Sweden.
Pavol Privitzer, Institute of Pathological Physiology, Praha, Czech Republic.
Reino Ruusu, VTT, Espoo, Finland.
Per Sahlin, Equa Simulation AB, Stockholm, Sweden.
Wladimir Schamai, EADS, Hamburg, Germany.
Gerhard Schmitz, University of Hamburg, Hamburg, Germany.
Klas Sjöholm, PELAB, Linköping University, Linköping, Sweden.
Anton Sodja, University of Ljubljana, Ljubljana, Slovenia
Ingo Staack, IEI, Linköping University, Linköping, Sweden.
Kristian Stavåker, PELAB, Linköping University, Linköping, Sweden.
Sonia Tariq, PELAB, Linköping University, Linköping, Sweden.
Hubert Thierot, CEP Paristech, Ecole des Mines, Paris, France.
Mohsen Torabzadeh-Tari, PELAB, Linköping University, Linköping, Sweden.
Parham Vasaiely, EADS, Hamburg, Germany.
Niklas Worschech, Bosch-Rexroth, Lohr am Main, Germany.
Robert Wotzlaw, Goettingen, Germany.
Björn Zachrisson, MathCore Engineering AB, Linköping, Sweden.
Azam Zia, PELAB, Linköping University, Linköping, Sweden.

32.6 OpenModelica Contributors 2010

Peter Fritzon, PELAB, Linköping University, Linköping, Sweden.

Adrian Pop, PELAB, Linköping University, Linköping, Sweden.
Martin Sjölund, PELAB, Linköping University, Linköping, Sweden.
Per Östlund, PELAB, Linköping University, Linköping, Sweden.

Peter Aronsson, MathCore Engineering AB, Linköping, Sweden.
Adeel Asghar, PELAB, Linköping University, Linköping, Sweden.
David Akhvlediani, PELAB, Linköping University, Linköping, Sweden.
Bernhard Bachmann, Fachhochschule Bielefeld, Bielefeld, Germany.
Vasile Baluta, PELAB, Linköping University, Linköping, Sweden.
Simon Björklén, PELAB, Linköping University, Linköping, Sweden.
Mikael Blom, PELAB, Linköping University, Linköping, Sweden.
Robert Braun, IEI, Linköping University, Linköping, Sweden.
Willi Braun, Fachhochschule Bielefeld, Bielefeld, Germany.
David Broman, PELAB, Linköping University, Linköping, Sweden.
Stefan Brus, PELAB, Linköping University, Linköping, Sweden.
Francesco Casella, Politecnico di Milano, Milan, Italy.
Filippo Donida, Politecnico di Milano, Milan, Italy.
Henrik Eriksson, PELAB, Linköping University, Linköping, Sweden.
Anders Fernström, PELAB, Linköping University, Linköping, Sweden.
Jens Frenkel, TU Dresden, Dresden, Germany.
Pavel Grozman, Equa AB, Stockholm, Sweden.
Michael Hanke, NADA, KTH, Stockholm.
Daniel Hedberg, MathCore Engineering AB, Linköping, Sweden.
Alf Isaksson, ABB Corporate Research, Västerås, Sweden.
Kim Jansson, PELAB, Linköping University, Linköping, Sweden.
Daniel Kanth, Bosch-Rexroth, Lohr am Main, Germany.
Tommi Karhela, VTT, Espoo, Finland.
Joel Klinghed, PELAB, Linköping University, Linköping, Sweden.
Petter Krus, IEI, Linköping University, Linköping, Sweden.
Juha Kortelainen, VTT, Espoo, Finland.
Alexey Lebedev, Equa Simulation AB, Stockholm, Sweden.
Magnus Leksell, Linköping, Sweden.
Oliver Lenord, Bosch-Rexroth, Lohr am Main, Germany.
Ariel Liebman, Energy Users Association of Australia, Victoria, Australia.
Rickard Lindberg, PELAB, Linköping University, Linköping, Sweden.
Håkan Lundvall, PELAB, Linköping University, Linköping, Sweden.
Henrik Magnusson, Linköping, Sweden.
Eric Meyers, Pratt & Whitney Rocketdyne, Palm City, Florida, USA.
Hannu Niemistö, VTT, Espoo, Finland.
Peter Nordin, IEI, Linköping University, Linköping, Sweden.
Kristoffer Norling, PELAB, Linköping University, Linköping, Sweden.
Lennart Ochel, Fachhochschule Bielefeld, Bielefeld, Germany.
Atanas Pavlov, Munich, Germany.

Karl Pettersson, IEI, Linköping University, Linköping, Sweden.
Pavol Privitzer, Institute of Pathological Physiology, Praha, Czech Republic.
Reino Ruusu, VTT, Espoo, Finland.
Per Sahlin, Equa Simulation AB, Stockholm, Sweden.
Wladimir Schamai, EADS, Hamburg, Germany.
Gerhard Schmitz, University of Hamburg, Hamburg, Germany.
Klas Sjöholm, PELAB, Linköping University, Linköping, Sweden.
Anton Sodja, University of Ljubljana, Ljubljana, Slovenia
Ingo Staack, IEI, Linköping University, Linköping, Sweden.
Kristian Stavåker, PELAB, Linköping University, Linköping, Sweden.
Sonia Tariq, PELAB, Linköping University, Linköping, Sweden.
Mohsen Torabzadeh-Tari, PELAB, Linköping University, Linköping, Sweden.
Niklas Worschech, Bosch-Rexroth, Lohr am Main, Germany.
Robert Wotzlaw, Goettingen, Germany.
Björn Zachrisson, MathCore Engineering AB, Linköping, Sweden.

32.7 OpenModelica Contributors 2009

Peter Fritzon, PELAB, Linköping University, Linköping, Sweden.
Adrian Pop, PELAB, Linköping University, Linköping, Sweden.

Peter Aronsson, MathCore Engineering AB, Linköping, Sweden.
David Akhvlediani, PELAB, Linköping University, Linköping, Sweden.
Bernhard Bachmann, Fachhochschule Bielefeld, Bielefeld, Germany.
Vasile Baluta, PELAB, Linköping University, Linköping, Sweden.
Constantin Belyaev, Bashpromavtomatika Ltd., Ufa, Russia
Simon Björklén, PELAB, Linköping University, Linköping, Sweden.
Mikael Blom, PELAB, Linköping University, Linköping, Sweden.
Willi Braun, Fachhochschule Bielefeld, Bielefeld, Germany.
David Broman, PELAB, Linköping University, Linköping, Sweden.
Stefan Brus, PELAB, Linköping University, Linköping, Sweden.
Francesco Casella, Politecnico di Milano, Milan, Italy
Filippo Donida, Politecnico di Milano, Milan, Italy
Henrik Eriksson, PELAB, Linköping University, Linköping, Sweden.
Anders Fernström, PELAB, Linköping University, Linköping, Sweden.
Jens Frenkel, TU Dresden, Dresden, Germany.
Pavel Grozman, Equa AB, Stockholm, Sweden.
Michael Hanke, NADA, KTH, Stockholm
Daniel Hedberg, MathCore Engineering AB, Linköping, Sweden.

Alf Isaksson, ABB Corporate Research, Västerås, Sweden
Kim Jansson, PELAB, Linköping University, Linköping, Sweden.
Daniel Kanth, Bosch-Rexroth, Lohr am Main, Germany
Tommi Karhela, VTT, Espoo, Finland.
Joel Klinghed, PELAB, Linköping University, Linköping, Sweden.
Juha Kortelainen, VTT, Espoo, Finland
Alexey Lebedev, Equa Simulation AB, Stockholm, Sweden
Magnus Leksell, Linköping, Sweden
Oliver Lenord, Bosch-Rexroth, Lohr am Main, Germany
Håkan Lundvall, PELAB, Linköping University, Linköping, Sweden.
Henrik Magnusson, Linköping, Sweden
Eric Meyers, Pratt & Whitney Rocketdyne, Palm City, Florida, USA.
Hannu Niemistö, VTT, Espoo, Finland
Kristoffer Norling, PELAB, Linköping University, Linköping, Sweden.
Atanas Pavlov, Munich, Germany.
Pavol Privitzer, Institute of Pathological Physiology, Praha, Czech Republic.
Per Sahlin, Equa Simulation AB, Stockholm, Sweden.
Gerhard Schmitz, University of Hamburg, Hamburg, Germany
Klas Sjöholm, PELAB, Linköping University, Linköping, Sweden.
Martin Sjölund, PELAB, Linköping University, Linköping, Sweden.
Kristian Stavåker, PELAB, Linköping University, Linköping, Sweden.
Mohsen Torabzadeh-Tari, PELAB, Linköping University, Linköping, Sweden.
Niklas Worschech, Bosch-Rexroth, Lohr am Main, Germany
Robert Wotzlaw, Goettingen, Germany
Björn Zachrisson, MathCore Engineering AB, Linköping, Sweden

32.8 OpenModelica Contributors 2008

Peter Fritzon, PELAB, Linköping University, Linköping, Sweden.

Adrian Pop, PELAB, Linköping University, Linköping, Sweden.

Peter Aronsson, MathCore Engineering AB, Linköping, Sweden.
David Akhvlediani, PELAB, Linköping University, Linköping, Sweden.
Bernhard Bachmann, Fachhochschule Bielefeld, Bielefeld, Germany.
Vasile Baluta, PELAB, Linköping University, Linköping, Sweden.
Mikael Blom, PELAB, Linköping University, Linköping, Sweden.

David Broman, PELAB, Linköping University, Linköping, Sweden.
Henrik Eriksson, PELAB, Linköping University, Linköping, Sweden.
Anders Fernström, PELAB, Linköping University, Linköping, Sweden.
Pavel Grozman, Equa AB, Stockholm, Sweden.
Daniel Hedberg, MathCore Engineering AB, Linköping, Sweden.
Kim Jansson, PELAB, Linköping University, Linköping, Sweden.
Joel Klinghed, PELAB, Linköping University, Linköping, Sweden.
Håkan Lundvall, PELAB, Linköping University, Linköping, Sweden.
Eric Meyers, Pratt & Whitney Rocketdyne, Palm City, Florida, USA.
Kristoffer Norling, PELAB, Linköping University, Linköping, Sweden.
Anders Sandholm, PELAB, Linköping University, Linköping, Sweden.
Klas Sjöholm, PELAB, Linköping University, Linköping, Sweden.
Kristian Stavåker, PELAB, Linköping University, Linköping, Sweden.
Simon Bjorklén, PELAB, Linköping University, Linköping, Sweden.
Constantin Belyaev, Bashpromavtomatika Ltd., Ufa, Russia

32.9 OpenModelica Contributors 2007

Peter Fritzon, PELAB, Linköping University, Linköping, Sweden.

Adrian Pop, PELAB, Linköping University, Linköping, Sweden.

Peter Aronsson, MathCore Engineering AB, Linköping, Sweden.
David Akhvlediani, PELAB, Linköping University, Linköping, Sweden.
Bernhard Bachmann, Fachhochschule Bielefeld, Bielefeld, Germany.
David Broman, PELAB, Linköping University, Linköping, Sweden.
Henrik Eriksson, PELAB, Linköping University, Linköping, Sweden.
Anders Fernström, PELAB, Linköping University, Linköping, Sweden.
Pavel Grozman, Equa AB, Stockholm, Sweden.
Daniel Hedberg, MathCore Engineering AB, Linköping, Sweden.
Ola Leifler, IDA, Linköping University, Linköping, Sweden.
Håkan Lundvall, PELAB, Linköping University, Linköping, Sweden.
Eric Meyers, Pratt & Whitney Rocketdyne, Palm City, Florida, USA.
Kristoffer Norling, PELAB, Linköping University, Linköping, Sweden.
Anders Sandholm, PELAB, Linköping University, Linköping, Sweden.
Klas Sjöholm, PELAB, Linköping University, Linköping, Sweden.
William Spinelli, Politecnico di Milano, Milano, Italy

Kristian Stavåker, PELAB, Linköping University, Linköping, Sweden.

Stefan Vorkoetter, MapleSoft, Waterloo, Canada.

Björn Zachrisson, MathCore Engineering AB, Linköping, Sweden.

Constantin Belyaev, Bashpromavtomatika Ltd., Ufa, Russia

32.10 OpenModelica Contributors 2006

Peter Fritzson, PELAB, Linköping University, Linköping, Sweden.

Peter Aronsson, MathCore Engineering AB, Linköping, Sweden.

Adrian Pop, PELAB, Linköping University, Linköping, Sweden.

David Akhvlediani, PELAB, Linköping University, Linköping, Sweden.

Bernhard Bachmann, Fachhochschule Bielefeld, Bielefeld, Germany.

David Broman, PELAB, Linköping University, Linköping, Sweden.

Anders Fernström, PELAB, Linköping University, Linköping, Sweden.

Elmir Jagudin, PELAB, Linköping University, Linköping, Sweden.

Håkan Lundvall, PELAB, Linköping University, Linköping, Sweden.

Kaj Nyström, PELAB, Linköping University, Linköping, Sweden.

Lucian Popescu, MathCore Engineering AB, Linköping, Sweden.

Andreas Remar, PELAB, Linköping University, Linköping, Sweden.

Anders Sandholm, PELAB, Linköping University, Linköping, Sweden.

32.11 OpenModelica Contributors 2005

Peter Fritzson, PELAB, Linköping University, Linköping, Sweden.

Peter Aronsson, PELAB, Linköping University and MathCore Engineering AB, Linköping, Sweden.

Adrian Pop, PELAB, Linköping University, Linköping, Sweden.

Håkan Lundvall, PELAB, Linköping University, Linköping, Sweden.

Ingemar Axelsson, PELAB, Linköping University, Linköping, Sweden.

David Broman, PELAB, Linköping University, Linköping, Sweden.

Daniel Hedberg, MathCore Engineering AB, Linköping, Sweden.

Håkan Lundvall, PELAB, Linköping University, Linköping, Sweden.

Kaj Nyström, PELAB, Linköping University, Linköping, Sweden.

Lucian Popescu, MathCore Engineering AB, Linköping, Sweden.

Levon Saldamli, PELAB, Linköping University, Linköping, Sweden.

32.12 OpenModelica Contributors 2004

Peter Fritzson, PELAB, Linköping University, Linköping, Sweden.

Peter Aronsson, Linköping University, Linköping, Sweden.

Bernhard Bachmann, Fachhochschule Bielefeld, Bielefeld, Germany.

Peter Bunus, PELAB, Linköping University, Linköping, Sweden.

Daniel Hedberg, MathCore Engineering AB, Linköping, Sweden.

Håkan Lundvall, PELAB, Linköping University, Linköping, Sweden.

Emma Larsdotter Nilsson, PELAB, Linköping University, Linköping, Sweden.

Kaj Nyström, PELAB, Linköping University, Linköping, Sweden.

Adrian Pop, PELAB, Linköping University, Linköping, Sweden.

Lucian Popescu, MathCore Engineering AB, Linköping, Sweden.

Levon Saldamli, PELAB, Linköping University, Linköping, Sweden.

32.13 OpenModelica Contributors 2003

Peter Fritzson, PELAB, Linköping University, Linköping, Sweden.

Peter Aronsson, Linköping University, Linköping, Sweden.

Levon Saldamli, PELAB, Linköping University, Linköping, Sweden.

Peter Bunus, PELAB, Linköping University, Linköping, Sweden.

Vadim Engelson, PELAB, Linköping University, Linköping, Sweden.

Daniel Hedberg, Linköping University, Linköping, Sweden.

Eva-Lena Lengquist-Sandelin, PELAB, Linköping University, Linköping, Sweden.

Susanna Monemar, PELAB, Linköping University, Linköping, Sweden.

Adrian Pop, PELAB, Linköping University, Linköping, Sweden.

Erik Svensson, MathCore Engineering AB, Linköping, Sweden.

32.14 OpenModelica Contributors 2002

Peter Fritzson, PELAB, Linköping University, Linköping, Sweden.

Levon Saldamli, PELAB, Linköping University, Linköping, Sweden.

Peter Aronsson, Linköping University, Linköping, Sweden.

Daniel Hedberg, Linköping University, Linköping, Sweden.

Henrik Johansson, PELAB, Linköping University, Linköping, Sweden

Andreas Karström, PELAB, Linköping University, Linköping, Sweden

32.15 OpenModelica Contributors 2001

Peter Fritzson, PELAB, Linköping University, Linköping, Sweden.

Levon Saldamli, PELAB, Linköping University, Linköping, Sweden.

Peter Aronsson, Linköping University, Linköping, Sweden.

32.16 OpenModelica Contributors 2000

Peter Fritzson, PELAB, Linköping University, Linköping, Sweden.

32.17 OpenModelica Contributors 1999

Peter Fritzson, PELAB, Linköping University, Linköping, Sweden

Peter Rönnquist, PELAB, Linköping University, Linköping, Sweden.

32.18 OpenModelica Contributors 1998

Peter Fritzson, PELAB, Linköping University, Linköping, Sweden.

David Kågedal, PELAB, Linköping University, Linköping, Sweden.

Vadim Engelson, PELAB, Linköping University, Linköping, Sweden.

BIBLIOGRAPHY

- [CK06] Francois E. Cellier and Ernesto Kofman. *Continuous System Simulation*. Springer-Verlag New York, Inc., Secaucus, NJ, USA, 2006. ISBN 0387261028.
- [DN10] T. A. Davis and E. Palamadai Natarajan. Algorithm 907: klu, a direct sparse solver for circuit simulation problems. *ACM Trans. Math. Softw.*, 37(3):36:1–36:17, September 2010. URL: <http://doi.acm.org/10.1145/1824801.1824814>, doi:10.1145/1824801.1824814.
- [HNorsettW93] E. Hairer, S. P. Nørsett, and G. Wanner. *Solving Ordinary Differential Equations I: Nonstiff Problems*. Springer-Verlag Berlin Heidelberg, 2nd rev. ed. 1993. corr. 3rd printing 2008 edition, 1993. ISBN 978-3-540-56670-0. doi:10.1007/978-3-540-78862-1.
- [HBG+05] A. C. Hindmarsh, P. N. Brown, K. E. Grant, S. L. Lee, R. Serban, D. E. Shumaker, and C. S. Woodward. SUNDIALS: suite of nonlinear and differential/algebraic equation solvers. *ACM Transactions on Mathematical Software (TOMS)*, 31(3):363–396, 2005.
- [Pet82] L.R. Petzold. Description of dassl: a differential/algebraic system solver. 1982.
- [Axe05] Ingemar Axelsson. OpenModelica Notebook for interactive structured Modelica documents. Master's thesis, Linköping University, Department of Computer and Information Science, October 2005. LITH-IDA-EX-05/080-SE.
- [Fernstrom06] Anders Fernström. Extending OpenModelica Notebook – an interactive notebook for structured Modelica documents. Master's thesis, Linköping University, Department of Computer and Information Science, September 2006. LITH-IDA-EX-06/057-SE.
- [Fri04] Peter Fritzson. *Principles of Object-Oriented Modeling and Simulation with Modelica 2.1*. Wiley-IEEE Press, February 2004. ISBN 0-471-471631.
- [Knu84] Donald E. Knuth. Literate programming. *The Computer Journal*, 27:97–111, 1984.
- [Wol96] Stephen Wolfram. *The Mathematica Book*. Wolfram Media/Cambridge University Press, third edition, 1996.
- [BOR+12] Bernhard Bachmann, Lennart Ochel, Vitalij Ruge, Mahder Gebremedhin, Peter Fritzson, Vaheed Nezhadali, Lars Eriksson, and Martin Sivertsson. Parallel multiple-shooting and collocation Optimization with OpenModelica. In Martin Otter and Dirk Zimmer, editors, *Proceedings of the 9th International Modelica Conference*. Linköping University Electronic Press, September 2012. doi:10.3384/ecp12076659.
- [RBB+14] Vitalij Ruge, Willi Braun, Bernhard Bachmann, Andrea Walther, and Kshitij Kulshreshtha. Efficient implementation of collocation methods for optimization using openmodelica and adol-c. In Hubertus Tummescheit and Karl-Erik Årzén, editors, *Proceedings of the 10th International Modelica Conference*. Modelica Association and Linköping University Electronic Press, March 2014. doi:10.3384/ecp140961017.

O

- OMEdit, 172
- OMSimulator, 107
 - Examples, 108
 - Flags, 107
- OMSimulatorLib, 108
 - C-API, 109
- OMSimulatorLua, 124
 - Examples, 124
 - Scripting Commands, 124
- OMSimulatorPython, 140
 - Examples, 140
 - Scripting Commands, 140
- OpenModelicaScripting, 155
 - Examples, 156
 - Scripting Commands, 156

S

- SSP, 176
 - Bus connections, 176
 - TLM connections, 178
 - TLM Systems, 178